

MEASURING INSTRUMENTS AND TESTERS

- Electrical Installation Safety
- High Voltage Insulation / Continuity / Earth
- Appliance / Machine / Switchboard Safety
- Power Quality Analysis
- LAN Cabling Certification
- Indoor Environment Quality
- Digital Multimeters / Clamp Meters / Voltage and Continuity Testers
- Variable transformers / Equipment for laboratories and Schools



www.metrel.si

Metrel d.d.; Ljubljanska c. 77; SI -1354 Horjul; Slovenia



CATALOGUE 2014

Metrel - Measuring and Regulation Equipment Manufacturer

Metrel is an international Group and an expert in the research, development and production of test and measurement equipment. Metrel brand name is worldwide recognized and associated with high quality test and measurement products.

Our commitment to quality is recognized by our customers and is ensured by continuous and extensive research and development of new, accurate, reliable and safe to use products.

services including the testing of components, subassemblies and prototypes of products. This enables Metrel to launch safe and reliable new products into the market. The laboratory provides testing according to the Low Voltage Directive (2006/95/EC) and the EMC Directive (2004/108/EC). The main standards that Metrel also complies to include IEC/EN 61010 and IEC/EN 61326.

Metrel's instruments provide test and measurement solutions in different maintenance areas including the safety testing of electrical installations and appliances, power quality analysis, local area network analysis and the measurement of indoor environmental conditions. In short, our products help to provide information about the safety and functionality of different installations and environments. Through innovative design, electronics and software solutions we provide accurate, reliable and safe to use products.

The company strives to be the leader in advanced technological solutions and therefore invests over 10 % of the yearly turnover into the R&D department.

Our wide range of products is backed up with a complete support package including repair and calibration, technical support and customer training programs. A detailed calibration certificate is supplied as standard with all Metrel products.



PRODUCTS

Metrel is producing test and measurement equipment that is covering the following fields:

- **Electrical Installations Safety Testing** (IEC/EN 61557, VDE 0413, VDE 0100, BS 7671, HD 60364, CEI 64.8, AS/NZS 3017, AS/NZS3760).
- **Portable Appliances, Machines and Switchgears Safety Testing** (IEC/EN 60204-1, IEC/EN 61439-1, IEC/EN 60335-1, VDE 0701-0702).
- **Measurement and Testing of Cable Networks** (TIA/EIA-568-B, ISO 11801, EN 50173, EN 50346, IEC/EN 61935).
- **Testing of Power Distribution Systems and Power Quality Analysis** (EN 50160).
- **Analysis of Indoor Environment Quality** (DIN 5032, IEC/EN 60584-1, EN 12599, EN ISO 7726, ISO 11664).
- **Equipment for Laboratories and Schools:** Metrel produces a variety of instruments for electrical testing laboratories and educational purposes. Typical application areas are: electrical workshops, testing labs, research, development and education. The main products Metrel produces include demo boards, power supply units, R-L-C decodes.
- **Transformers:** Metrel produces two kinds of toroidal transformers: variable transformers (according to standard EN60989) and power transformers (according to standard EN 61558).

ECOLOGY

Metrel test and measurement equipment complies to the RoHS and WEEE directives. Metrel strives to meet its goals with the most efficient use of resources and the least possible impact on the environment.



SALES NETWORK

Metrel's products are sold and serviced in over 80 countries by local agents and distributors. Our associated companies are managed by local people who know the special needs of their markets. Sales engineers and specially trained technicians staff give excellent service to our customers.

The GERMAN market is supported by Metrel GmbH based in Eckental (www.metrel.de) and the UK market is supported by Metrel UK based in Normanton (www.metrel.co.uk). Inquiries for other countries please direct to Metrel d.d., the headquarters based in SLOVENIA (www.metrel.si).

COMMITMENT TO QUALITY

Metrel's quality assurance system is based on BS EN ISO 9001. Through permanent training and education of our employees we strive to increase the efficiency and quality of all our processes.

RESEARCH, DEVELOPMENT AND PRODUCTION

The research, development and production of Metrel's products are based in Europe (Slovenia) at Metrel d.d. The company strives for total quality control. A dedicated quality assurance department ensures strict adherence to customer specifications. Highly competent R&D engineers provide advanced solutions for our customers.

TEST LABORATORY

The highly professional test laboratory based in Metrel d.d. provides internal

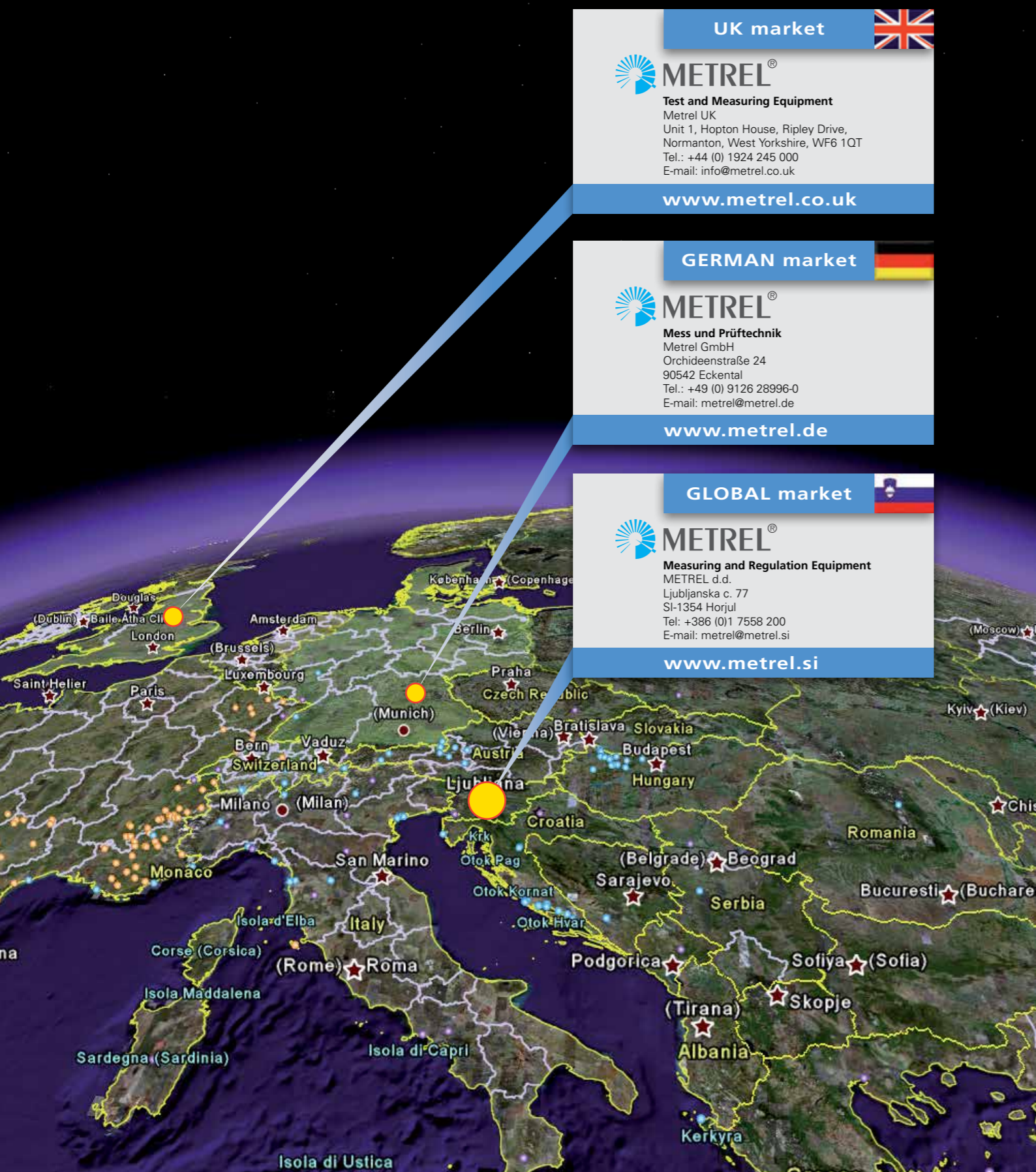

UK market



Test and Measuring Equipment
Metrel UK
Unit 1, Hopton House, Ripley Drive,
Normanton, West Yorkshire, WF6 1QT
Tel.: +44 (0) 1924 245 000
E-mail: info@metrel.co.uk

www.metrel.co.uk

GERMAN market



Mess und Prüftechnik
Metrel GmbH
Orchideenstraße 24
90542 Eckental
Tel.: +49 (0) 9126 28996-0
E-mail: metrel@metrel.de

www.metrel.de

GLOBAL market



Measuring and Regulation Equipment
METREL d.d.
Ljubljanska c. 77
SI-1354 Horjul
Tel: +386 (0)1 7558 200
E-mail: metrel@metrel.si

www.metrel.si

Metrel - Measuring and Regulation Equipment Manufacturer

SERVICES

Metrel provides a variety of services relating to training, repair and calibration of test equipment to the highest standards in the industry.

REPAIR

Metrel provides fast and efficient repair services either directly at Metrel's head quarters service centre or through approved business partners.

CALIBRATION

The Calibration Laboratory at Metrel DUS is able to calibrate electronic measuring instruments and devices in compliance with the requirements of the ISO/IEC 17025 standard. The laboratory is accredited by Slovenian Accreditation (SA), a member of European Accreditation (EA), signatory of the Multilateral Agreements for the European Co-operation for Accreditation (EA) and International Laboratory Accreditation Co-operation (ILAC) for calibration and testing.

The products from the calibration can be issued with an Inspection report and a

Calibration certificate (non accredited). Accredited calibration certificate can also be issued if it is required by the customer.

TECHNICAL SUPPORT

Metrel provides the following support to its customers and distributors:

- **On-line technical support:** any inquiries related to Metrel products can be sent onto a designated e-mail address:
 - help@metrel.si - GLOBAL market;
 - info@metrel.co.uk - UK market;
 - metrel@metrel.de - GERMAN market.
- **Technical support line:** the technical support can be obtained also over the phone:
 - +386 (0)1 7558 200 - GLOBAL market;
 - +44 (0) 1924 245 000 - UK market;
 - +49 (0) 9126 28996-0 - GERMAN market.
- **B2B web support:** for Metrel partners a B2B zone enables to obtain technical and marketing information.
- **Download centre:** enables to download files with technical product information. Visit www.metrel.si/support/download-centre.html.

TRAINING CENTER

Metrel d.d. offers to its customers and distributors:

- **Training on Metrel's instruments:** the product training can be customized on the customer's needs. Metrel can offer training on technical standards, measuring and test methods, use and application of Metrel instruments.
- **Complete distributor setup training:** when establishing a new distributor, Metrel can offer a complete "package" on product training, repair and calibration training and assign in establishing a local calibration and repair department.
- **Training for calibration and repair of Metrel products:** this is help for Metrel's existing and new distributors to enable a high standard of local support to customers who purchase a Metrel product.
- **Bespoke training for larger end users:** In case that a larger customer is requesting training, Metrel can organize the training according to their specific needs. This can be carried out on site or at Metrel's premises.

Instruments Designed with Future in Mind

METREL is one of the world leading manufacturers and distributor of high quality electrical measurement and test instruments, providing the market with innovative solutions on the following segments:

Electrical Installation Safety

Metrel offers single and multifunctional electrical installation testers. The instruments are used for initial and periodic testing of domestic and industrial installations, testing of single and multiphase systems and testing of TT, TN, IT and 115 V systems. Metrel meters offer wide selection of functionalities and measurements (depending on the model), can be downloadable or non-downloadable. All meters comply with the European standard IEC/EN 61557.

High Voltage Diagnostics

Metrel's high voltage diagnostic equipment (5 ... 10 kV) is used for testing insulation resistance of rotating machinery and cables, production line periodic testing and maintenance, troubleshooting and analysis of all kinds of insulation problems. It gives effective readings in high noise environments such as high voltage substations and switchyards. Some of key features of Metrel's instruments (depends on the model) are PI, DD, DAR testing, R(t) graph plotting, high 5 mA charging current, selectable noise rejection filters, etc.

Portable Appliance / Machine / Switch-board Safety

Metrel's testers can be used in professional PAT testing, general PAT testing, factory / warehouse PAT testing, multi-location PAT testing and after repair safety testing. Metrel's instruments offer a selection of key features for example auto sequencing, automatic testing, Pass / Fail evaluation of results, RCD testing, project uploading, bar-coding system and Pass / Fail barcode label printing, flash test, test of both 230 V appliances and 115 V appliances and many more.

Power Quality Analysis

The power quality analysers can be widely used for general power quality assessment in distribution and industrial low and middle voltage electric systems (according to EN 50160), capturing and recording of power supply events, flicker measurement, power factor correction measurements, harmonics measurements, transients recording and over-voltage protection devices performance testing, assessment of UPS, consumption profile recording, ect.

Lan Cabling Certification

Metrel's LAN testers are designed to be used for verification of copper cabling networks up to CAT VI / Class E, trouble-

shooting and fault finding of connections / links, troubleshooting in IT networks.

Indoor Environment Quality

Metrel's indoor environmental measuring instruments are used for measurement, recording and analysis of various indoor ambient parameters. The testers integrate a number of innovative solutions and fit the most demanding applications such as testing of indoor air quality, factory climatic conditions, lightning conditions; heat, ventilation and air conditioning systems testing, indoor or dry outdoor sound level measurement, industrial sound measurement, band-pass and acoustic filter testing, calibration work, acoustic equipment testing and much more.

Digital Multimeters / Clamp Meters / Voltage And Continuity Testers

The digital multimeters, clamp meters and voltage continuity testers are used for general / basic testing up to high level industrial testing, electronic fault finding, field servicing and heavy duty electrical testing. Some of the key features (depending on the model) are TRMS testing, high accuracy, temperature measurement, lead alert, conductance, PC communication, autocheck function, recording of data, etc.

Contact us

GLOBAL market

Measuring and Regulation Equipment
METREL d.d.
Ljubljanska c. 77
SI-1354 Horjul



Tel.: +386 (0)1 75 58 200
E-mail: metrel@metrel.si
Web: www.metrel.si

GERMAN market

Mess und Prüftechnik
Metrel GmbH
Orchideenstraße 24
90542 Eckental



Tel.: +49 (0) 9126 28996-0
E-mail: metrel@metrel.de
Web: www.metrel.de

UK market

Test and Measuring Equipment
Metrel UK
Unit 1, Hopton House, Ripley Drive,
Normanton, West Yorkshire, WF6 1QT



Tel.: +44 (0) 1924 245 000
E-mail: info@metrel.co.uk
Web: www.metrel.co.uk

Metrel WEB

Metrel WEB page offers you:

- General information about our products with quick and practical SEARCH function for product searching.
- Detailed information about our products in extended product specifications.
- Latest information about training and seminars.
- Service information.
- Download centre.
- Helpdesk, improved with ticketing system.
- Answers to common questions related to our products under Frequent Asked Questions (FAQ) rubric.
- News and information about exhibitions, fairs, meetings and conferences.
- Faster and more sufficient activities in relations with our worldwide distributors (B2B).
- Links to other interesting sites that offers information about occupation safety, metrology, technical heritage, standardization, regulations, technical experience.



Contents

Electrical Installation Safety

1.1 - 1.66

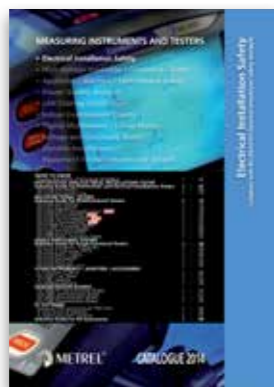

LAN Cabling Certification

5.1 - 5.08



High Voltage Diagnostics

2.1 - 2.34



Indoor Environment Quality

6.1 - 6.16



Appliance / Machine / Switchboard Safety

3.1 - 3.40



Digital Multimeters / Clamp Meters / Voltage and Continuity Testers

7.1 - 7.30



Power Quality Analysis

4.1 - 4.26



Variable transformers / Equipment for laboratories and Schools

8.1 - 8.05



MEASURING INSTRUMENTS AND TESTERS

- Electrical Installation Safety
- High Voltage Insulation / Continuity / Earth
- Appliance / Machine / Switchboard Safety
- Power Quality Analysis
- LAN Cabling Certification
- Indoor Environment Quality
- Digital Multimeters / Clamp Meters / Voltage and Continuity Testers
- Variable transformers / Equipment for laboratories and Schools

GOOD TO KNOW

Testing the Safety of Electrical Installation 1 - 02

PHOTOVOLTAIC AND ELECTRICAL INSTALLATIONS TESTER

Selection Guide for Photovoltaic and Electrical installations Testers 1 - 07

MI 3108 EurotestPV 1 - 08

MI 3109 EurotestPV Lite 1 - 10

MULTIFUNCTIONAL TESTERS

Selection Guide for Multifunctional Testers 1 - 12

MI 3105 EurotestXA 1 - 14

MI 3101 EurotestAT 1 - 16

MI 3102H BT EurotestXE 2.5 kV **NEW** 1 - 18

MI 3102 BT EurotestXE **NEW** 1 - 20

MI 3100 SE EurotestEASL **NEW** 1 - 22

MI 3100 s EurotestEASL **NEW** 1 - 24

MI 3125BT EurotestCOMBO 1 - 26

MI 3125 EurotestCOMBO 1 - 28

MI 2086 Eurotest 61557 1 - 30

MI 2088 Earth - Insulation Tester 1 - 32

SINGLE-FUNCTIONAL TESTERS

Selection Guide for Single-functional Testers 1 - 34

MI 3121 Insulation / Continuity 1 - 36

MI 3122 Z Line-Loop / RCD 1 - 38

MI 3123 Earth / Clamp 1 - 40

MI 3110 EurotestIM 1 - 42

MI 2126 Earth 2/3 1 - 44

MI 3103 GigaOhm 1 kV 1 - 45

OTHER INSTRUMENTS / ADAPTERS / ACCESSORIES

A 1143 Euro Z 290 A 1 - 46

MI 2093 Line Tracer 1 - 47

A 1199 p adapter 1 - 48

CS 2099 Eurocheck 1 - 49

DEMONSTRATION BOARDS

MI 3088 PV Demonstration Board 1 - 50

MA 2067 Demonstration Board 1 - 51

MI 3099 Demonstration Board 1 - 52

MI 2166 Demonstration Board 1 - 53

PC SOFTWARE

EuroLink PRO and EuroLink PRO Plus 1 - 54

A 1431 EuroLink Android 1 - 56

A 1428 EuroLinkPV Android 1 - 57

Selection Guide for EIS Accessories 1 - 58

Electrical Installation Safety Testing

Find out more about testing safety of electrical installations

According to European standards requirements electrical installation safety testing includes a combination of following tests:

- Insulation resistance,
- Continuity of protective conductors and equipotential bonding,
- RCD testing,
- Line and fault loop impedance,
- Earth resistance testing (two-wire method without probes, three / four-wire method with two probes, method with current clamp and two probes, method with two current clamps)
- Specific earth resistance,
- Phase sequence, voltage and frequency.

These tests are performed in order to ensure that the requirements are met for the protection of persons, livestock and property against the risk of electric shock and to ensure that the automatic disconnection of the supply is performed correctly.

Insulation resistance

The insulation is intended to prevent any contact with live parts and withstanding mechanical, chemical, electrical and thermal stresses. Insulation test discloses insulation faults caused by pollution, moisture, deterioration of insulation materials etc. Insulation resistance measurement is covered by the IEC / EN 61557-2 standard.

The power must be switched off and the installation must be disconnected before performing this test to ensure that the test voltage will not be applied to other equipment electrically connected to the circuit to be tested, particularly devices sensitive to voltage surges.

Insulation resistance shall be measured between:

- Line conductors,
- Line and PE conductors,
- Line and Neutral conductors,
- Neutral and PE conductors.

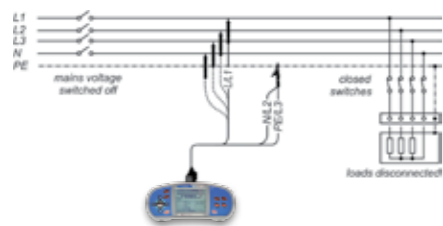

Test circuit for insulation resistance measurement

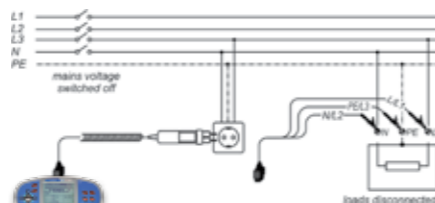

Test circuit for insulation resistance measurement

The insulation resistance test is performed with a DC voltage on a dead system and the resistance must be above the minimum limit set out in the appropriate standards and regulations. Limit values for electrical installations acc. to IEC 60364-6:

Rated voltage of circuit (V)	DC test voltage (V)	Insulation resistance (MΩ)
LV secondary switchboard or LV main switchboard	250	≥0.5
Less than or equal to 500 V including LV main switchboard	500	≥1.0
Greater	1.000	≥1.0

METREL's hint:

EurotestAT and EurotestXA have built-in the "Insulation ALL" function which enables performing of 3-port insulation test (L-N, L-PE, N-PE or L1-L2, L1-L3, L2-L3) in one step. This is a very time saving feature especially if measuring insulation on outlets.

Continuity of protective conductors and equipotential bonding

The purpose of continuity measurement is to check the continuity of the protective conductors, the main and supplementary equipotential bonds. The test is carried out using a measurement instrument capable of generating a no-load voltage of 4 to 24 V (DC or AC) with a minimal current of 200 mA.

Continuity test is covered by the EN 61557-4 standard.

The measured resistance must be lower than a threshold specified by the standard applicable to the installation tested, which is usually 2 Ω. As the resistance value is low, the resistance of the measurement leads must be compensated, particularly if very long leads are used.

METREL's hint:

EurotestAT and EurotestXA can perform the N – PE loop test between instrument's N and PE test terminals. This makes testing with the plug test cable on outlets possible.

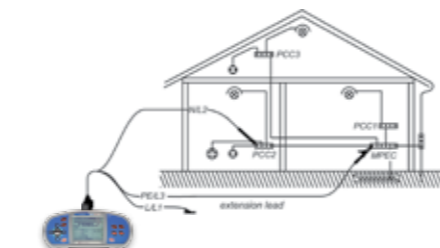

Test circuit for continuity R200 mA measurement



Test circuit for continuous resistance measurement

RCD testing

RCD devices are used as protection against dangerous fault voltages and fault currents. Various test and measurements are required for verification of RCDs in RCD protected installations. Measurements are based on the EN 61557-6 standard.

Scope of RCD test is:

- to verify effectiveness and proper operation of the RCDs;
- to verify disconnection times and trip out currents of RCDs;
- to verify that there are no or limited present fault currents in the installation.

The following measurements and tests of RCDs can be performed:

- Contact voltage,
- Trip-out time,
- Trip-out current,
- RCD autotest.

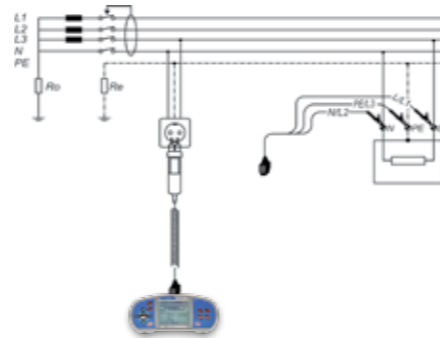

Circuit for testing RCD

METREL's hint:

METREL installation testers have built-in the "RCD AUTO" function which performs RCD testing at x1/2, x1 and x5 current multipliers at both 0° and 180° automatically.

Electrical Installation Safety Testing

With this function all relevant RCD tests can be carried out in one step which is very simple and time saving feature.

RCD selection table according to their sensitivity:

	AC type	A type	B type
	✓	✓	✓
	No response	✓	✓
	No response	No response	✓

Line impedance

Line impedance is measured in loop comprising of mains voltage source and line wiring (between the line and neutral conductors or between lines on a 3-phase system). It is covered by requirements of the EN 61557-3 standard.

Scope of line impedance test is:

- to verify effectiveness of installed over current devices;
- to verify internal impedance for supplying purpose.

The line-neutral short circuit loop consists of:

- Power transformer secondary impedance Z_T ,
- Z_L (phase wiring from source to fault),
- Z_N (neutral wiring from source to fault).

The line to neutral impedance is the sum of impedances and resistances that forms the line to neutral loop. In three phase system there are three line-neutral impedances (Z_{L1-N} , Z_{L2-N} , Z_{L3-N}).

$$Z_{LN} = Z_L + Z_N + Z_{TLN}$$

The prospective short circuit current I_{PSC} is defined as:

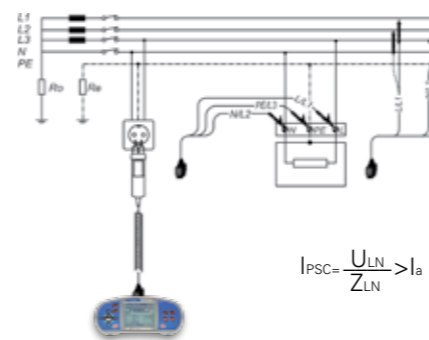

Circuit for measurement of line impedance

I_{PSC} must be higher than current for rated disconnection time of the over current disconnection device. The line – neutral (or line - line) impedance should be low enough e.g. prospective short circuit current high enough that installed protection device will disconnect the short circuit loop within the prescribed time interval.

METREL's hint:

METREL installation testers have built-in tables with fuses and RCDs parameters. When line test is performed, the measured value is automatically compared to the maximum values set out in the standard (EN 61557) and either a PASS or FAIL symbol will appear on the screen to inform the user if the result is within the required limits.

Fault loop impedance

Fault loop is a loop comprising mains source, line wiring and PE return path to the mains source. The measurement is covered by requirements of the EN 61557-3 standard.

Scope of loop impedance test is:

- to verify effectiveness of installed over current and / or residual current disconnection devices;
- to verify fault loop impedances, prospective fault currents and fault voltage values.

In TN systems the fault loop Z_{L-PE} consists of:

- Z_T (power transformer secondary impedance);
- Z_L (phase wiring from source to fault);
- R_{PE} (PE / PEN wiring from fault to source).

The fault loop impedance is the sum of impedances and resistances that forms the fault loop.

$$Z_{LPE} = Z_L + R_{PE} + Z_T$$

The prospective fault current I_{PSC} is defined as:

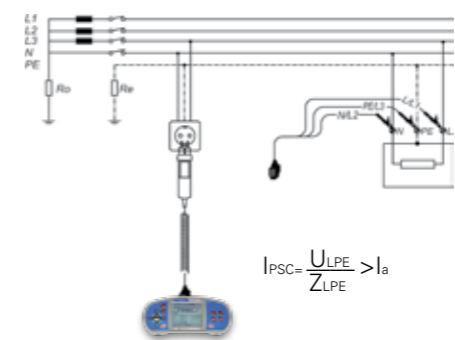

Circuit for measurement of fault loop impedance

METREL's hint:

METREL installation testers have built-in tables with fuses and RCDs parameters. When loop test is performed, the measured value is automatically compared to the maximum values set out in the standard (EN 61557) and either a PASS or FAIL symbol will appear on the screen to inform the user if the result is within the required limits.

Earth resistance

Earth resistance testing is used on TN, TT and IT systems to ensure that the resistance of the earth electrode is sufficiently low so that, in the case of a fault, a dangerous voltage does not appear on any parts of the installation or on any appliances which have a connection to earth.

The measurement conforms to the EN 61557-6 standard.

Scope of earth resistance test is:

- Earthing of exposed conductive parts assures that the voltage on them stays below dangerous level in case of a fault.

In TN installations the earthing is realized at the source and / or distribution points that's why the earthing resistances are usually very low (below 1Ω).

TT installations have their own main earthing. The resistances are usually higher than in TN systems (from few Ω up to several hundred Ω). Because of this dangerous fault voltages and body currents can occur at relatively low fault currents. Therefore TT systems usually have additional RCD protection.

The following earth resistance measuring methods are available:

- Standard 3-wire (4-wire) method for standard resistance to earth measurements;
- 3-wire (4-wire) method with one clamp, for measuring resistance to earth of individual earthing rods;
- Two clamps method for measuring resistance to earth of individual earthing rods (recommended in IEC 60364-6 for urban areas);
- Specific earth resistance (is carried out in order to assure more accurate calculation of earthing systems e.g. for high-voltage distribution columns, large industrial plants, lightning systems etc.).

Electrical Installation Safety Testing

Connection diagrams:

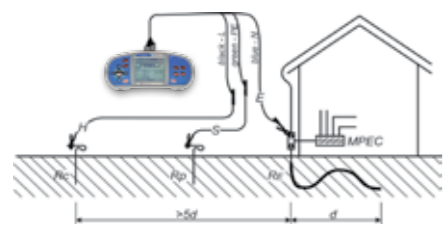

Circuits for three-wire measurement

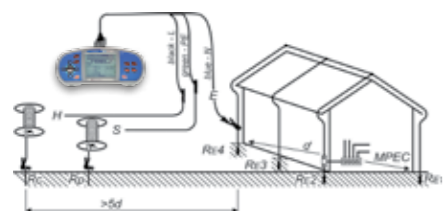

Circuits for three-wire measurement

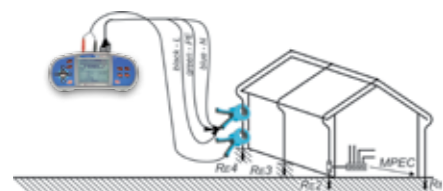

Circuit for two clamps measurement

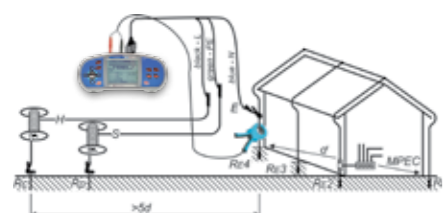

Circuit for one clamp measurement

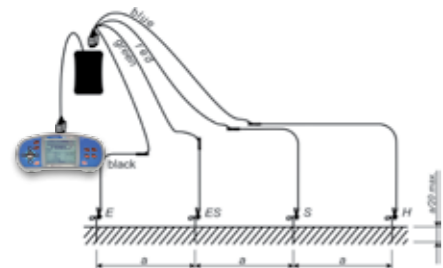

Circuit for measurement of specific earth resistance

Recommended earth resistance measuring methods:

TN system

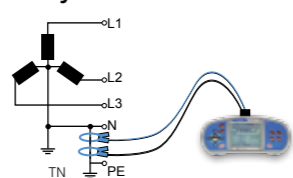

Two clamps method (clamps around main N/PE cable).

TT system

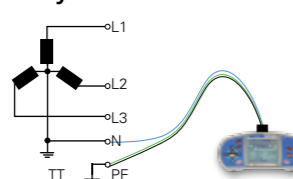

Two-wire method (test from the socket between N and PE)

IT system

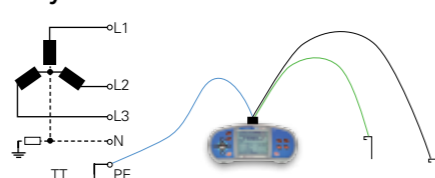

Three-wire method (test leads to auxiliary rods in triangle)

Lightning conductor

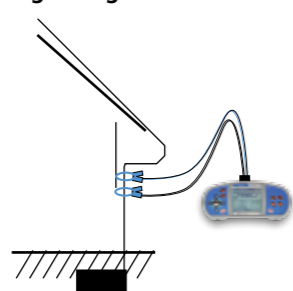

Two clamps method

Limits:

- 2 Ω – above ground,
- 10 Ω – complete system,
- 20 Ω – individual electrode or 8% of specific earth resistance.

Phase sequence, voltage and frequency

Phase sequence test is used for determining of line voltages order in 3-phase systems. This order defines direction of rotation of motors and generators.

Phase sequence measurement conforms to the EN 61557-7 standard.

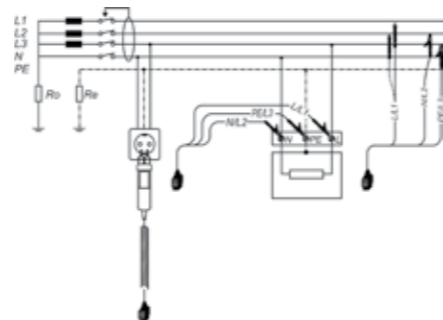

Circuit for voltage measurements



Circuit for voltage measurement, frequency and phase sequence

METREL's hint:

METREL installation testers have on-line voltage monitor which in all functions displays on one screen voltages between L to PE, L to N and N to PE (single phase system) or L1 to L2, L2 to L3 and L1 to L3 (3-phase system). This feature allows quickly identify incorrect connections, disconnected wires or incorrect voltages.

PE test terminal

A very dangerous situation can occur in case dangerous voltage is applied to the PE wire or other accessible metal parts. A common reason for this fault is incorrect wiring. Metrel's instruments are equipped with touchable PE electrode (TEST key). When touching TEST key in all functions that require mains supply the user automatically performs test for the presence of phase voltage at the PE protection terminal.

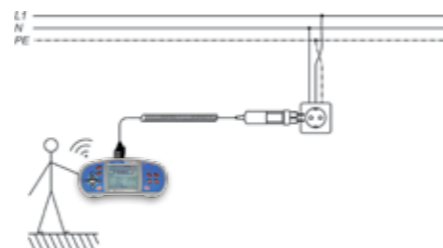

Example for application of PE test terminal

Electrical Installation Safety Testing

Overvoltage category

The overvoltage category specifies the highest mains voltage (or lightning strike, short circuit due to incorrect use, etc.) that the instrument can withstand without danger for the tester or for the object being measured. The standard specifies four overvoltage categories. The overvoltage category affects component sizing via the air gap. The higher the category, the bigger is the distance to the power source.

CAT I - electronic devices, signal level.

CAT II - domestic appliances, portable appliances, single-phase loads, sockets, (>10 m from CAT III; >20 m from CAT IV).

CAT III - three-phase distribution systems, lighting systems in large buildings, distribution panels.

CAT IV - three-phase systems on power stations, electricity meters, outdoor installations and supply cable incoming feed.

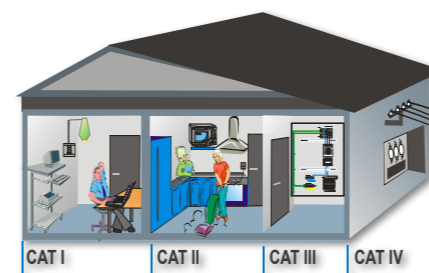

AUTO SEQUENCE®

is a unique patented by Metrel testing procedure which allows performing of series of requested installation tests with a single press of TEST button. The results of each test are automatically compared to pre-set limits and PASS / FAIL evaluated.

While ensuring efficient, fast and easy way of installation safety testing AUTO SEQUENCE® guarantees absolute safety of operator due to automatic detection of possible irregular installation conditions.

Definite number of test sequences is already stored in the instrument. Besides, user can program and store custom test sequences.

The user can choose appropriate pre-programmed AUTO SEQUENCE® procedure according to following criterions:

- which part of electrical installation will be tested;
- which earthing system is implemented (TN, TT or IT);

- is the installation single- or three-phase;
 - is the RCD present in the installation.
- To simplify the selection of the appropriate test sequence the detailed flow chart is supplied with the instrument.

After choosing the AUTO SEQUENCE® and setting the limits the user just has to press TEST button and the sequence will automatically perform all predefined tests. When the sequence is finished,

the instrument will display overall PASS / FAIL decision. All the results can be saved to the structured instrument's memory at once for further data verification and automatic generation of test report with the help of the PC SW EuroLink PRO.

The revolutionary AUTO SEQUENCE® procedure allows performing testing up to 5 times faster in comparison with conventional methods.

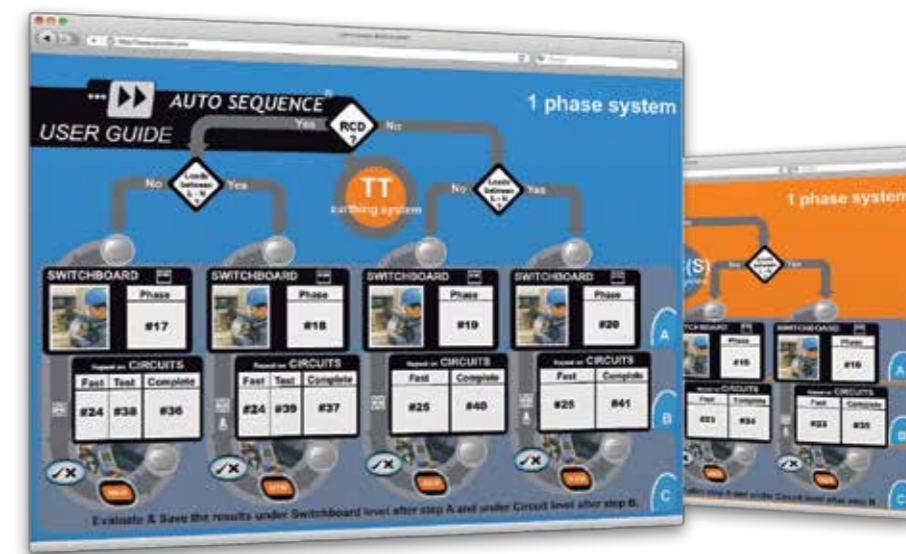

Guide through Verification on Low-voltage electrical installations : IEC 60364-6



**Electrical and Photovoltaic
Installations Tester:
MI 3108 EurotestPV**



Selection Guide for Photovoltaic and Electrical installations Testers

Part No.		MI 3108 EurotestPV	MI 3109 EurotestPV Lite
Features	Description		
ELECTRICAL INSTALLATION SAFETY	Insulation resistance up to 1000 V	✓	✓
	Continuity 200 mA	✓	✓
	Line / Loop Impedance	✓	-
	RCD A, AC, B	✓	-
	Earth resistance	✓	-
	Rotary field	✓	-
PV GENERATOR MEASUREMENTS	Isc, Uoc	1000 V / 15 A	1000 V / 15 A
	Automatic test sequence	-	✓
	I-V curve	✓	✓
	Umpp, Impp, Pmax	✓	✓
	extrapolation to STC	✓	✓*
	Rs (calculated in PC SW)	✓	✓
ENVIRONMENT MEASUREMENTS	Irradiance	✓	✓*
	Module temperature	✓	✓*
PV SYSTEM POWER MEASUREMENTS	DC side measurements U, I, P	✓	✓
	AC side measurements (single phase) U, I, P	✓	✓
	PV and inverter energy conversion efficiency	✓	✓
EXTENDED POWER FUNCTIONALITY	P, Q, S, THDU, PF/cos φ	✓	-
	AC/DC current	✓	-
	Scope function	✓	-
	Energy	✓	-
	Harmonics (up to 11 th)	✓	-
GENERAL DATA	Memory size	I-V curve: ca. 500 meas. Other: ca 1800 meas.	
	Supply	6 x AA	
	Built-in battery charger	✓	✓
	Display	128 x 64 BW LCD	
	Overvoltage category	CAT II / 1000 V DC CAT III / 600 V CAT IV / 300 V	
	PC connectivity	✓	✓
	PC Software	EuroLink PRO	EuroLink PRO
	Weight (kg)	1.3	1.3
	Dimensions (mm)	230 x 103 x 115	230 x 103 x 115

* Environment data can be entered manually or measured with optional accessory

MI 3108 EurotestPV

MI 3108 EurotestPV is a combined photovoltaic tester and electrical installations safety tester. It enables complete testing of electrical installations according to EN 61557 standards and in addition performs all necessary tests required on single-phase photovoltaic (PV) installations. This includes all of the tests as required by EN 62446, but also includes I - U characteristic, Calculation of STC values and power measurements on Inverter's DC and AC sides. The unit is designed for the demanding working conditions (up to 1000 V, with 15 A DC). To greatly improve user safety the MI 3108 EurotestPV comes with the PV Safety Probe which ensures safe disconnection every time.

MEASURING FUNCTIONS:

Photovoltaic installations:

- **Measurements on DC side of PV installation:**
 - Voltage, current, power;
 - U_{oc} (Open Circuit Voltage) and I_{sc} (Short Circuit Current);
 - I - U curve of PV modules and strings;
 - Irradiance;
 - Module temperature.
- **Measurements on AC side of PV installation (power quality):**
 - Voltage, current, frequency, power, PF, energy, harmonics;
 - Efficiency of PV module, inverter, PV system calculation.

Electrical installations:

- Insulation resistance;
- Continuity of PE conductors;
- Line impedance;
- Loop impedance (sub-functions with high current and without RCD tripping);
- RCD testing (type AC, A and B);
- Earth resistance;
- AC current (load and leakage);
- TRMS voltage, frequency, phase sequence;
- Power, energy, harmonics.

KEY FEATURES:

Photovoltaic installations:

- **Calculation of STC values:** the measured current and voltage values are, according to environment conditions, recalculated to Standard Test Condition values which makes possible, to compare the results even if they were taken under different test conditions.
- **Graphical representation:** the I-V characteristic of PV module or string is graphically represented on LCD display.
- **Power and efficiency measurements:** 2 voltage & 2 current channels for simultaneous AC & DC parameters measurements.
- **PV Remote Unit:** Optional unit for simultaneous measurements of solar irradiation and temperature of PV module.



Electrical installations

- **RCD Auto:** Automated RCD testing procedure significantly reduces test time.
- **Trip Lock function:** Loop impedance test are performed without tripping the RCD.
- **B type RCD testing:** is supported.
- **Earth resistance measurement:** instrument supports 3-wire earth resistance testing.
- **Built-in fuse tables:** for automatic evaluation of the line / loop impedance results.
- **Online voltage monitoring:** monitors all 3 voltages in real time.
- **Scope function:** real-time U/I scope.
- **Harmonics analysis:** 1-phase power and energy measurements with up to 11th harmonics analysis is supported.
- **Memory:** Up to 1800 test results or up to 500 graphical results with timestamp can be stored in internal memory.
- **BT connectivity:** it enables BT communication with Android tablets and smart phones via optional BT dongle.
- **Downloadable:** PC SW EuroLink PRO enables downloading, review, analyses and printing of test results.

APPLICATION:

- Testing, evaluations and troubleshooting of photovoltaic installations.
- Power and energy efficiency measurements (AC and DC).
- Initial and periodic testing of domestic and industrial single and three-phase electrical installations.

STANDARDS:

Functionality:

IEC/EN 61557 series;
IEC 62446 (photovoltaics).

Other reference standards for testing:

BS 7671;
EN 61008;
EN 61009;
EN 60364-4-41;
AS/NZ 3760

Electromagnetic compatibility:

EN 61326

Safety:

EN 61010-1;
EN 61010-2-030;
EN 61010-031;
EN 61010-2-032

TECHNICAL DATA:

PHOTOVOLTAIC INSTALLATION MEASUREMENTS		
Function	Measuring range	Basic accuracy
Voltage	0 V _{DC} ... 999 V _{DC} 0 V _{AC} ... 999 V _{AC} I-V m.: 0 V _{DC} ... 999 V _{DC}	±(1.5 % of reading + 5 digits) ±(1.5 % of reading + 3 digits) ±(2 % of reading + 2 digits)
Current	Panel m.: 0.0 mA ... 300 A _{DC} Invert. m.: 0.0 mA ... 300 A _{AC} I-V m.: 0.00 A ... 15 A _{DC}	±(1.5 % of reading + 5 digits) ±(1.5 % of reading + 3 digits) ±(2 % of reading + 3 digits)
Power	Panel m.: 0 ... 200 kW I-V m.: 0 ... 15 kW	±(2.5 % of reading + 6 digits) ±(3 % of reading + 5 digits)
Energy	0.000 Wh - 1999 kWh	
U / I curve	1000 V / 15 A / 15 kW	
Harmonics	up to 11 th	
Irradiation	0 ... 2000 W/m ²	±(5 % of reading + 5 digits)
Temperature	-10 °C ... + 85 °C	± 5 digits
ELECTRICAL INSTALLATION MEASUREMENTS		
Function	Measuring range	Basic accuracy
Insulation resistance (EN 61557-2)	U = 50, 100, 250 V _{DC} : R: up to 199.9 MΩ U = 500 V _{DC} , 1 kV _{DC} : R: up to 999 MΩ	±(5 % of reading + 3 digits) ±(5 % of reading + 3 digits)
Continuity, 200 mA (EN 61557-4)	0.00 Ω ... 1999 Ω	±(3 % of reading + 3 digits)
Continuity, 7 mA	0.0 Ω ... 1999 Ω	±(5 % of reading + 3 digits)
Loop impedance (EN 61557-3)	0.00 Ω ... 9.99 kΩ	±(5 % of reading + 5 digits)
Line impedance (EN 61557-3)	0.00 Ω ... 9.99 kΩ	±(5 % of reading + 5 digits)
Voltage	0 V _{AC} ... 550 V _{AC}	±(2 % of reading + 2 digits)
Frequency	0.00 Hz ... 499.9 Hz	±(0.2 % of reading + 1 digits)
Phase sequence (EN 61557-7)	1.2.3 or 3.2.1	
RCD testing (EN 61557-6)	I _{ΔN} : 10 mA, 30 mA, 100 mA, 300 mA, 500 mA, 1 A	
- Contact voltage U _c	0.0 V ... 99.9 V	(-0 % / +15 %) of reading
- Trip-out time	0 ms ... max. time	±1 ms
- Trip-out current	0.2 x I _{ΔN} ... 2.2 x I _{ΔN}	±0.1 x I _{ΔN}
Earth resistance (EN 61557-5)	0.00 Ω ... 9999 Ω	±(5 % of reading + 5 digits)
General	Main unit	Remote unit
Display	128 x 64 dots matrix display with backlight	128 x 64 dots matrix display with backlight
Power supply	6 x 1.2 V NiMH batteries, type AA	6 x 1.2 V NiMH batteries, type AA
Overvoltage category	CAT II / 1000 V _{DC} ; CAT III / 600 V; CAT IV / 300 V	
Protection class	double insulation	
COM port	RS232 and USB	RS232
Dimensions	230 x 103 x 115 mm	140 x 230 x 80 mm
Weight	1.3 kg	1.0 kg

STANDARD SET:

MI 3108 ST

- Instrument MI 3108 EurotestPV
- Soft carrying bag, 2 pcs
- Schuko-plug test cable
- Test lead, 3 x 1.5 m
- Test probe, 4 pcs (red, green, blue, black)
- Crocodile clip, 3 pcs (red, green, blue, black)
- PV Safety Probe
- PV MC3/4 male/female adapters
- AC/DC current clamp
- PV Reference Cell
- Temperature probe
- USB and RS232 - PS/2 cable
- Power supply adapter + 6 NiMH batteries,

type AA

- PC SW EuroLink PRO
- Set of carrying straps
- Short instruction manual
- Instruction manual and handbook on CD
- Calibration certificate

MI 3108 PS

- MI 3108 ST
- EurotestPV Remote
- Tip commander
- PC SW EuroLink PRO Plus licence



MI 3108 PS

MI 3109 EurotestPV Lite

MI 3109 EurotestPV Lite is a photovoltaic (PV) tester. It performs all necessary tests required on photovoltaic installations. This includes all of the tests as required by EN 62446, but also includes I - U characteristic measurements, calculation of STC values and power measurements on Inverter's DC and AC sides (single-phase only). MI 3109 EurotestPV Lite is optimized for PV tests therefore the Autotest operation mode is implemented which is intended to perform a complete set of test needed for verification of PV installations according to EN 62446 with pressing off only one button. With this instrument the tests for the first inspection of PV systems as well as periodic maintenance tests, evaluation tests or troubleshooting tests are possible. With optional accessories the same PV test functionality as with MI 3108 EurotestPV is available.

MEASURING FUNCTIONS:

Photovoltaic installations:

- **Measurements on DC side of PV installation:**
 - Insulation resistance;
 - Continuity of PE conductors;
 - Uoc (Open Circuit Voltage) and Isc (Short Circuit Current);
 - I - U curve of PV modules and strings;
 - Voltage, current and power of strings and inverters;
 - Irradiance;
 - Module temperature.
- **Measurements on AC side of PV installation:**
 - Voltage, current, power;
 - Efficiency of PV module, inverter, PV system calculation.



KEY FEATURES:

- **Insulation and I-U curve measurements in one instrument:** with MI 3109 only one instrument is needed to perform insulation measurements with up to 1000V for proofing the PV installation safety and I-U curve measurements needed for evaluation and troubleshooting of PV modules or strings.
- **Autotest:** This function is intended to perform a complete set of tests according to EN 62446 on PV modules or strings with pressing only one button:
 - insulation resistance between positive output and earth;
 - insulation resistance between negative output and earth;
 - open circuit voltage;
 - short circuit current.
- **Calculation to STC values:** the measured current and voltage values are, according to environment conditions, recalculated to Standard Test Condition values which makes possible to compare the results of different measurements even if they were taken under different test conditions.

- **Efficiency calculations:** 2 voltage & 2 current channels for simultaneous AC & DC parameters measurements.
- **PV Remote Unit:** Optional unit for simultaneous measurements of solar irradiation and temperature of PV module.
- **Graphical representation of module's I - U curve:** the I-V characteristic of PV module or string is graphically represented on LCD display.
- **Memory:** Up to 1800 test results or up to 500 graphical results with timestamp can be stored in internal memory.
- **BT connectivity:** it enables BT communication with Android tablets and smart phones via optional BT dongle.
- **Downloadable:** PC SW EuroLink PRO enables downloading, review, analyses and printing of test results.

APPLICATION:

- First inspection Testing.
- Periodic maintenance tests.
- Evaluation and troubleshooting of photovoltaic installations.
- Power and efficiency measurements (AC and DC).

STANDARDS:

Functionality:

IEC/EN 61557 series;
IEC 62446 (photovoltaics).

Other reference standards for testing:

BS 7671;
EN 61008;
EN 61009;
EN 60364-4-41;
AS/NZ 3760

Electromagnetic compatibility:

EN 61326

Safety:

EN 61010-1;
EN 61010-2-030;
EN 61010-031;
EN 61010-2-032

TECHNICAL DATA:

PHOTOVOLTAIC INSTALLATION MEASUREMENTS		
Function	Measuring range	Basic accuracy
Voltage	0 V _{DC} ... 999 V _{DC} 0 V _{AC} ... 999 V _{AC} I-V m.: 0 V _{DC} C ... 999 V _{DC}	±(1.5 % of reading + 5 digits) ±(1.5 % of reading + 3 digits) ±(2 % of reading + 2 digits)
Current	Panel m.: 0.0 mA ... 300 A _{DC} Invert. m.: 0.0 mA ... 300 A _{AC} I-V m.: 0.00 A ... 15 A _{DC}	±(1.5 % of reading + 5 digits) ±(1.5 % of reading + 3 digits) ±(2 % of reading + 3 digits)
Power	Panel m.: 0 ... 200 kW I-V m.: 0 ... 15 kW	±(2.5 % of reading + 6 digits) ±(3 % of reading + 5 digits)
U / I curve	1000 V / 15 A / 15 kW	
Irradiation	0 ... 2000 W/m ²	±(5 % of reading + 5 digits)
Temperature	-10 °C ... + 85 °C	± 5 digits
ELECTRICAL INSTALLATION MEASUREMENTS		
Function	Measuring range	Basic accuracy
Insulation resistance (EN 61557-2)	U = 50, 100, 250 V _{DC} :	±(5 % of reading + 3 digits)
	R: up to 199.9 MΩ	
	U = 500 V _{DC} , 1 kV _{DC} :	
	R: up to 999 MΩ	±(5 % of reading + 3 digits)
Continuity, 200 mA (EN 61557-4)	0.00 Ω ... 1999 Ω	±(3 % of reading + 3 digits)
Continuity, 7 mA	0.0 Ω ... 1999 Ω	±(5 % of reading + 3 digits)
Display	128 x 64 dots matrix display with backlight	
Power supply	6 x 1.2 V NiMH batteries, type AA	
Overvoltage category	CAT II / 1000 V _{DC} ; CAT III / 600 V; CAT IV / 300 V	
Protection class	double insulation	
COM port	RS232 and USB	
Dimensions	230 x 103 x 115 mm	
Weight	1.3 kg	

STANDARD SET:

MI 3109 ST

- Instrument MI 3109 EurotestPV Lite
- Soft carrying bag
- Universal PV test lead, 3 x 1.5 m
- PV Continuity test lead, 2 x 1.5 m
- Test probe, 3 pcs (red, blue, green)
- Crocodile clip, 3 pcs (red, blue, green)
- PV MC3/4 male/female adapters
- AC/DC current clamp
- Power supply adapter + 6 NiMH batteries, type AA
- USB and RS232 - PS/2 cable
- PC SW EuroLink PRO

- Carrying strap
- Short instruction manual
- Instruction manual and handbook on CD
- Calibration certificate

MI 3109 PS

- MI 3109 ST
- EurotestPV Remote
- PV Safety Probe
- PV Reference Cell
- Temperature probe
- Soft carrying bag
- PC SW EuroLink PRO Plus licence



MI 3109 ST

Selection Guide for Multifunctional Testers

Part No.		MI 3105 (EU) EurotestXA	MI 3101 EurotestAT	NEW MI 3102H BT EurotestXE 2.5kV
Features	Description			
INSULATION	Insulation resistance	✓	✓	✓
	Test voltage (V _{DC})	50 ... 1000	50 ... 1000	50 ... 2500
	Autotest insulation L-PE, N-PE, L-N	✓	✓	-
	Diagnostic test (PI, DAR calculation)	-	-	✓
CONTINUITY AND LOW RESISTANCE MEASUREMENT	Continuity of PE conductors with automatic polarity change, test current 200 mA	✓	✓	✓
	Low resistance measurement (continuous measurement), test current 7 mA	✓	✓	✓
	Line impedance with Ipsc calculation	✓	✓	✓
LINE / LOOP IMPEDANCE	Loop impedance with Ipsc calculation	✓	✓	✓
	RCD Trip Lock loop impedance	✓	✓	✓
	Built-in fuse tables for PASS / FAIL evaluation	✓	✓	✓
	Contact voltage measurement without RCD tripping	✓	✓	✓
RCD TESTING	RCD trip-out time	✓	✓	✓
	RCD trip-out current with rising test current	✓	✓	✓
	Automatic testing of RCDs	✓	✓	✓
	RCD type (general and selective)	A, AC, B	A, AC, B	A, AC
	AC voltage measurement	✓	✓	✓
VOLTAGE, FREQUENCY	Online voltage monitor	✓	✓	✓
	Frequency measurement	✓	✓	✓
	PHASE SEQUENCE	L1 - L2 - L3	✓	✓
EARTH MEASUREMENTS	Earth resistance 3-(4-)wire method	✓	✓	✓
	Earth resistance 3-(4-)wire method with additional current clamp	✓	-	-
	Earth resistance measurement with 2 current clamps	Option	-	Option
	Specific earth resistance	Option	Option	-
AUTO SEQUENCE	Automatic installation safety testing on Switchboards and Circuits	✓	✓	-
	Predifined mini Autosequences	-	-	✓
OTHER MEASUREMENTS	TRMS leakage / load current	✓	-	Option
	Illuminance measurement	Option	-	Option
	Varistor test	✓	✓	-
	Fuse / fault locator	Option	Option	-
	High resolution loop impedance (mΩ)	Option	Option	-
	Insulation Monitoring Devices (IMD) testing (IT systems)	✓	-	-
	First fault leakage current (ISFL) measurement (IT systems)	✓	✓	-
OTHER FEATURES	Nominal frequency range	14 ... 500 Hz	14 ... 500 Hz	45 ... 65 Hz
	PASS / FAIL evaluation of test results	✓	✓	✓
	IT earthing mode systems support	✓	✓	-
	Touch electrode	✓	✓	✓
	HELP menu	✓	✓	✓
COMMUNICATION PORTS	RS232 / USB	✓	✓	✓
	Bluetooth	Option	Option	✓
MEMORY SOFTWARE	Number of memory levels / memory locations	10 / 2000	10 / 2000	4 / 1800
	Professional PC SW	✓	✓	✓
	Advanced PC SW	✓	Option	Option
GENERAL DATA	Safety category	CAT III / 600 V CAT IV / 300 V	CAT III / 600 V CAT IV / 300 V	CAT III / 600 V CAT IV / 300 V
	Batteries	6 x AA	6 x AA	6 x AA
	Built-in battery charger	✓	✓	✓
	Weight (kg)	1.37	1.32	1.31
	Dimensions (mm)	230 x 103 x 115	230 x 103 x 115	230 x 103 x 115

NEW MI 3102 BT EurotestXE	NEW MI 3100 SE EurotestEASI	NEW MI 3100 s EurotestEASI	MI 3125 BT EurotestCOMBO	MI 3125 EurotestCOMBO	MI 2086 (EU) Eurotest 61557	MI 2088 Earth Insulation
✓	✓	✓	✓	✓	✓	✓
50 ... 1000	50 ... 1000	50 ... 1000	50 ... 1000	50 ... 1000	50 ... 1000	50 ... 1000
-	-	-	-	-	-	-
✓	✓	✓	✓	✓	✓	✓
✓	✓	✓	✓	-	✓	✓
✓	✓	✓	✓	✓	✓	-
✓	✓	✓	✓	✓	✓ (R)	-
✓	✓	✓	✓	✓	-	-
✓	✓	✓	✓	✓	✓	-
✓	✓	✓	✓	✓	✓	-
✓	✓	✓	✓	✓	✓	-
✓	✓	✓	✓	✓	✓	-
✓	✓	✓	✓	✓	✓	-
A, AC, B	A, AC	A, AC	A, AC, B	A, AC	A, AC	-
✓	✓	✓	✓	✓	✓	✓
✓	✓	✓	✓	✓	✓	-
✓	✓	✓	✓	✓	✓	-
✓	✓	✓	✓	✓	✓	-
✓	✓	✓	✓	✓	✓	-
Option	-	-	-	-	Option	Option
Option	-	-	-	-	Option	Option
-	-	-	-	-	✓	✓ (without p adapter)
Option	-	-	-	-	✓	Option
Option	-	-	-	-	Option	-
-	-	-	-	-	✓	✓
-	-	-	-	-	Option	-
-	-	-	-	-	Option	-
✓	-	-	-	-	-	-
✓	-	-	-	-	-	-
45 ... 65 Hz	45 ... 65 Hz	45 ... 65 Hz	45 ... 65 Hz	45 ... 65 Hz	45 ... 65 Hz	45 ... 65 Hz
✓	✓	✓	✓	✓	-	-
✓	-	-	-	-	-	-
✓	✓	✓	✓	✓	✓	-
✓	✓	✓	✓	✓	✓	-
✓	✓	✓	✓	✓	✓	-
✓	Option	-	✓	-	✓ / Option	✓ / Option
4 / 1800	4 / 1800	4 / 1800	4 / 1700	-	3 / 3000	2 / 1000
✓	✓	-	✓	-	✓	✓
Option	Option	-	Option	-	✓	-
CAT III / 600 V CAT IV / 300 V	CAT III / 600 V CAT IV / 300 V	CAT III / 600 V CAT IV / 300 V	CAT III / 600 V CAT IV / 300 V	CAT III / 600 V CAT IV / 300 V	CAT III / 300 V CAT II / 600 V	CAT III / 300 V CAT II / 600 V
6 x AA	6 x AA	6 x AA	6 x AA	6 x AA	4 x C	4 x C
✓	✓	✓	✓	✓	-	-
1.31	1.31	1.31	1.0	1.0	2.1	1.7
230 x 103 x 115	230 x 103 x 115	230 x 103 x 115	140 x 80 x 230	140 x 80 x 230	265 x 110 x 185	265 x 110 x 185

MI 3105 EurotestXA

The top model of Metrel's installation testers is MI 3105 EurotestXA. Features including "All-in-one" installation safety testing, *AUTO SEQUENCE*® testing, integrated characteristics of fuses and RCDs (including B type), PASS / FAIL evaluation of test results, 10-level memory structure and built-in battery charger make the EurotestXA an exemplary instrument. Additional features include TRMS current measurement, 3-wire / one clamp / two clamps earth resistance and 4-wire specific earth resistance measurements, illumination measurement and fuse / fault locator function. All the results can be quickly saved and then downloaded via the EuroLink PRO software to the computer for evaluation and professional report generation after testing. The MI 3105 EurotestXA performs continuity, insulation, RCD, loop, line, voltage, frequency, earth resistance and phase sequence testing required by the EN 61557 standard.

MEASURING FUNCTIONS:

- Insulation resistance with DC voltage;
- Continuity of PE conductors with 200 mA test current with polarity change;
- Continuity of PE conductors with 7 mA test current (continuous measurement) without RCD tripping;
- Line impedance;
- Loop impedance;
- Loop impedance with Trip Lock RCD function;
- TRMS voltage and frequency;
- Phase sequence;
- RCD testing (general and selective, type AC, A and B);
- Earth resistance (3-wire method, one clamp method, two clamps method);
- Specific earth resistance (option);
- TRMS leakage and load currents;
- Overvoltage protection devices testing;
- Illumination (option);
- Tracing the installations (option);
- Testing of Insulation Monitoring Devices (IMDs);
- First fault leakage current in IT systems;
- High resolution loop impedance (mΩ).

KEY FEATURES:

- **Autosequences:** Testing of electrical installation safety with *AUTO SEQUENCE*® is up to 5 times faster compared to traditional installation tester.
- **All-in-one insulation:** insulation tests between L-N, L-PE and N-PE can be performed simultaneously in less than 10 seconds.
- **Medical site testing:** measurement of First fault leakage current (ISFL) and insulation monitoring device (IMD) checking.
- **Structure building:** a structure of the installation (up to 10 levels) can be built either using the software (which can then be sent to the instrument) or directly on the tester so that test results are always saved on the correct circuit.
- **Barcode reading support:** reading of data from barcode labelled installation structure elements for fast naming of memory locations on the field.
- **Fuse location:** function enables the locating of fuses / wires / faults with the help of the optional A 1191 Fuse locator.
- **Earth resistance measurement:** Tester can perform 3-wire earth resistance testing, one clamp and two clamps earth resistance and specific earth resistance measurement.
- **Downloadable:** downloads via RS232 or



USB cable directly to the PC with the help of the software included in the standard set.

- **Help screens:** instrument comes complete with built-in help screens for referencing on site.
- **Built-in fuse tables:** this unique feature allows automatic evaluation of the line / loop impedance compared to the regulations.
- **Online voltage monitoring:** monitors all 3 voltages in real-time.
- **Upgradeable:** if changes occur to the regulations upgrades can be made to the firmware to keep the instrument up to date.
- **Polarity swap:** automatic polarity reversal on continuity test.
- **Insulation range:** wide range of insulation test voltages from 50 V to 1000 V, reading up to 1000 MΩ.
- **Trip Lock function:** Zs (RCD) function performs a loop impedance test without tripping the RCD.
- **Multi-system testing:** tests on TT, TN, IT and reduced low voltage systems.
- **Wide frequency range:** 14 ... 500 Hz.
- **Built-in charger & rechargeable batteries:** unit has a built-in charging circuit and comes complete with a set of rechargeable NiMH batteries.
- **RCD auto:** automated RCD testing procedure significantly reduces test time.
- **B type RCD testing** is supported.
- **BT connectivity:** it enables BT com-

munication with Android tablets and smart phones via optional BT dongle.

- **PC SW EuroLink PRO** included in the standard set enables downloading of test results and parameters and creation of test reports.

APPLICATION:

- Initial and periodic testing of domestic and industrial installations;
- Testing on high and low frequency installations e.g. testing in aviation, railway networks etc.;
- Testing of single and multiphase systems;
- Testing of TT, TN, IT and 115 V systems;
- High volume testing (industrial, aircraft, railway, mining, chemistry, ferry boat);
- Medical installation testing.

STANDARDS:

Functionality: IEC/EN 61557
Other reference standards for testing: IEC/EN/HD 60364; IEC/EN 61008; IEC/EN 61009; IEC/EN/TR 60755; BS 7671; AS/NZ 3760; AS/NZ 3018; AS/NZ 3017; CEI 64.8; HD 384; VDE 0413
Electromagnetic compatibility: IEC/EN 61326-1; IEC/EN 61326-2-2
Safety: IEC/EN 61010-1; IEC/EN 61010-031

TECHNICAL DATA:

Function	Measuring range	Resolution	Accuracy
Insulation resistance (EN 61557-2)	U=50, 100, 250 V _{DC} : R: 0.00 MΩ ... 19.99 MΩ 20.0 MΩ ... 199.9 MΩ 100.0 MΩ ... 999.9 MΩ	0.01 MΩ 0.1 MΩ 0.1 MΩ	±(5 % of reading + 5 digits) ±10 % of reading ±20 % of reading
	U= 500 V _{DC} , 1 kV _{DC} : R: 0.00 MΩ ... 19.99 MΩ 20.0 MΩ ... 199.9 MΩ 200 MΩ ... 299 MΩ 300 MΩ ... 1000 MΩ	0.01 MΩ 0.1 MΩ 1 MΩ 1 MΩ	±(5 % of reading + 3 digits) ±10 % of reading ±10 % of reading ±20 % of reading
Continuity 200mA of PE conductor with polarity change (EN 61557-4)	0.00 Ω ... 19.99 Ω 20.0 Ω ... 199.9 Ω 200 Ω ... 1999 Ω 2000 Ω ... 9999 Ω	0.01 Ω 0.1 Ω 1 Ω 1 Ω	±(3 % of reading + 3 digits) ±5 % of reading ±5 % of reading Indicator only
	Low resistance continuity measurement, test current 7 mA (Continuous measurement)	0.0 Ω ... 19.9 Ω 20 Ω ... 1999 Ω 2000 Ω ... 9999 Ω	0.1 Ω 1 Ω 1 Ω
Line impedance (EN 61557-3)	0.00 Ω ... 9.99 Ω 10.0 Ω ... 99.9 Ω 100 Ω ... 999 Ω 1.00 kΩ ... 9.99 kΩ 10.0 kΩ ... 19.9 kΩ	0.01 Ω 0.1 Ω 1 Ω 10 Ω 100 Ω	±(5 % of reading + 5 digits)
	Voltage drop	0.0 % ... 99.9 %	
Loop impedance (EN 61557-3)	0.00 Ω ... 9.99 Ω 10.0 Ω ... 99.9 Ω 100 Ω ... 1999 Ω	0.01 Ω 0.1 Ω 1 Ω	±(5 % of reading + 5 digits)
	Voltage	0 V ... 550 V	
Frequency	0.00 Hz ... 999.99 Hz	0.01 Hz	±(2 % of reading + 2 digits)
Phase sequence (EN 61557-7)	1,2,3 or 3,2,1		±(0.2 % of reading + 1 digit)
RCD testing (EN 61557-6)	I _{ΔN} : 10 mA, 30 mA, 100 mA, 300 mA, 500 mA, 1 A		
- Contact voltage U _c	0.0 V ... 19.9 V 20.0 V ... 99.9 V	0.1 V 0.1 V	(-0 % / +15 %) of reading ± 10 digits (-0 % / +15 %) of reading
- Trip-out time	0.0 ms ... 40.0 ms 0.0 ms ... max. time	0.1 ms 0.1 ms	±1 ms ±3 ms
- Trip-out current	0.2 x I _{ΔN} ... 1.1 x I _{ΔN} (AC type) 0.2 x I _{ΔN} ... 1.5 x I _{ΔN} (A type, I _{ΔN} ≥ 30 mA) 0.2 x I _{ΔN} ... 2.2 x I _{ΔN} (A type, I _{ΔN} < 30 mA) 0.2 x I _{ΔN} ... 2.2 x I _{ΔN} (B type)	0.05 x I _{ΔN} 0.05 x I _{ΔN} 0.05 x I _{ΔN} 0.05 x I _{ΔN}	±0.1 x I _{ΔN} ±0.1 x I _{ΔN} ±0.1 x I _{ΔN} ±0.1 x I _{ΔN}
Earth resistance (EN 61557-5) (three-wire method; one clamp method)	0.00 Ω ... 19.99 Ω 20.0 Ω ... 199.9 Ω 200 Ω ... 1999 Ω 2000 Ω ... 9999 Ω	0.01 Ω 0.1 Ω 1 Ω 1 Ω	±(3 % of reading + 3 digits) ±(3 % of reading + 3 digits) ±5 % of reading ±10 % of reading
	Earth resistance (two clamps method)	0.00 Ω ... 19.99 Ω 20.0 Ω ... 30.0 Ω 30.1 Ω ... 39.9 Ω	0.01 Ω 0.1 Ω 0.1 Ω
Specific earth resistance	0.0 Ωm ... 99.9 Ωm 100 Ωm ... 999 Ωm 1.00 kΩm ... 9.99 kΩm 10.0 kΩm ... 99.9 kΩm > 100 kΩm	0.1 Ωm 1 Ωm 0.01 kΩm 0.1 kΩm 1 kΩm	±5 % of reading ±5 % of reading ±5 % of reading; ±10 % of reading ±10 % of reading; ±20 % of reading ±20 % of reading
	TRMS Current	0.0 mA ... 99.9 mA 100 mA ... 999 mA 1.00 A ... 19.99 A	0.1 mA 1 mA 0.01 A
Illuminance (Type B)	0.00 lux ... 19.99 lux 20.0 lux ... 199.9 lux 200 lux ... 1999 lux 2.00 klux ... 19.99 klux	0.01 lux 0.1 lux 1 lux 10 lux	±(5 % of reading + 2 digits)
	Varistor Test	0 ... 625 V _{AC} ; 0 ... 1000 V _{DC}	
Power supply	6 x 1.2 V rechargeable batteries, type AA		
Overvoltage category	CAT III / 600 V; CAT IV / 300 V		
Protection class	Double insulation		
COM port	RS232 and USB		
Dimensions	230 x 103 x 115 mm		
Weight	1.3 kg		

STANDARD SET:

MI 3105 ST

- Instrument EurotestXA
- Plug commander, 1.5 m
- Test lead, 3 x 1.5 m
- Power supply adapter + 6 NiMH rechargeable batteries, type AA
- Test probe, 3 pcs (blue, black, green)
- Crocodile clip, 3 pcs (blue, black, green)
- RS232 - PS/2 cable
- USB cable
- Soft carrying bag

- Soft carrying neck belt
- PC Software EuroLink PRO
- Short instruction manual
- Instruction manual on CD
- Handbook on CD
- Calibration certificate

MI 3105 EU

- MI 3105 ST
- Current clamp A 1018 (low range, leakage)
- PC Software EuroLink PRO Plus



MI 3105 EU

MI 3101 EurotestAT

The MI 3101 EurotestAT is the first installation safety tester with automated testing based on patented technology **AUTO SEQUENCE®**. This remarkable instrument is equipped with a number of unique features including "All-in-one" installation safety testing, integrated characteristics of fuses and RCDs (including B type), **PASS / FAIL** evaluation of test results and **10-level memory structure**. Besides the EurotestAT has additional features like fuse / wire locating facility, specific earth resistance measuring function and built-in battery charger. All the results can be quickly saved and referenced on the instrument and then downloaded via the EuroLink PRO software, included in the standard set, to the computer for evaluation and report generation after testing. The MI 3101 EurotestAT performs continuity, insulation, RCD, loop, line, voltage, frequency, earth resistance testing and phase sequence tests required by the EN 61557 standard.

MEASURING FUNCTIONS:

- Insulation resistance with DC voltage;
- Continuity of PE conductors with 200 mA test current with polarity change;
- Continuity of PE conductors with 7 mA test current (continuous measurement) without RCD tripping;
- Line impedance;
- Loop impedance;
- Loop impedance with Trip Lock RCD function;
- TRMS voltage and frequency;
- Phase sequence;
- RCD testing (general and selective, type AC, A and B);
- Earth resistance (3-wire method);
- Specific earth resistance (option);
- Overvoltage protection devices testing;
- Tracing the installations (option);
- High resolution loop impedance (mΩ).

KEY FEATURES:

- **Autosequences:** Testing of electrical installation safety with **AUTO SEQUENCE®** is up to 5 times faster compared to traditional installation tester.
- **All-in-one insulation:** insulation tests between L-N, L-PE and N-PE can be performed simultaneously in less than 10 seconds.
- **Structure building:** a structure of the installation (up to 10 levels) can be built either using the software (which can then be sent to the instrument) or directly on the tester so that test results are always saved on the correct circuit.
- **Barcode reading support:** reading of data from barcode labelled installation structure elements for fast naming of memory locations on the field.
- **Fuse location:** function enables the locating of fuses / wires / faults with the help of the optional A 1191 Fuse locator.
- **Earth resistance measurement:** Unit can perform 3-wire earth resistance testing and specific earth resistance measurement.
- **Downloadable:** downloads via RS232 or USB cable directly to the PC with the help the software included in the standard set.



- **Help screens:** instrument comes complete with built-in help screens for referencing on site.
- **Built-in fuse tables:** this unique feature allows automatic evaluation of the line / loop impedance compared to the regulations.
- **Online voltage monitoring:** monitors all 3 voltages in real-time.
- **Upgradeable:** if changes occur to the regulations, upgrades can be made to the firmware to keep the instrument up to date.
- **Polarity swap:** automatic polarity reversal on continuity test.
- **Insulation range:** wide range of insulation test voltages from 50 V to 1000 V, reading up to 1000 MΩ.
- **Trip Lock function:** Zs (RCD) function performs a loop impedance test without tripping the RCD.
- **Multi-system testing:** tests on TT, TN, IT and 115 V systems.
- **Wide frequency range:** 14 ... 500 Hz.
- **Built-in charger & rechargeable batteries:** unit has a built-in charging circuit and comes complete with a set of rechargeable NiMH batteries.
- **RCD auto:** automated RCD testing procedure significantly reduces test time.
- **B type RCD testing** is supported.
- **BT connectivity:** it enables BT commu-

nication with Android tablets and smart phones via optional BT dongle.

- **PC SW EuroLink PRO** included in the the standard set enables downloading of test results and parameters and creation of test reports.

APPLICATION:

- Initial and periodic testing of domestic and industrial installations (testing in aviation, railway networks, agriculture);
- Testing of single and multiphase systems;
- Testing of TT, TN, IT and 115 V systems;
- High volume testing (industrial, aircraft, railway, mining, chemistry, ferry boat).

STANDARDS:

Functionality: IEC/EN 61557
Other reference standards for testing: IEC/EN/HD 60364; IEC/EN 61008; IEC/EN 61009; IEC/EN/TR 60755; BS 7671; AS/NZ 3760; AS/NZ 3018; AS/NZ 3017; CEI 64.8; HD 384; 0VDE 413
Electromagnetic compatibility: IEC/EN 61326-1; IEC/EN 61326-2-2
Safety: IEC/EN 61010-1; IEC/EN 61010-031

TECHNICAL DATA:

Function	Measuring range	Resolution	Accuracy
Insulation resistance (EN 61557-2)	U=50, 100, 250 V _{DC} : R: 0.00 MΩ ... 19.99 MΩ 20.0 MΩ ... 99.9 MΩ 100.0 MΩ ... 199.9 MΩ	0.01 MΩ 0.1 MΩ 0.1 MΩ	±(5 % of reading + 5 digits) ±10 % of reading ±20 % of reading
	U= 500 V _{DC} , 1 kV _{DC} : R: 0.00 MΩ ... 19.99 MΩ 20.0 MΩ ... 199.9 MΩ 200 MΩ ... 299 MΩ 300 MΩ ... 1000 MΩ	0.01 MΩ 0.1 MΩ 1 MΩ 1 MΩ	±(5 % of reading + 3 digits) ±10 % of reading ±10 % of reading ±20 % of reading
Continuity of PE conductor with polarity change, test current 200 mA (EN 61557-4)	0.00 Ω ... 19.99 Ω 20.0 Ω ... 199.9 Ω 200 Ω ... 1999 Ω 2000 Ω ... 9999 Ω	0.01 Ω 0.1 Ω 1 Ω 1 Ω	±(3 % of reading + 3 digits) ±5 % of reading ±5 % of reading Indicator only
	Low resistance continuity measurement, test current 7 mA (Continuous measurement)	0.0 Ω ... 19.9 Ω 20 Ω ... 1999 Ω 2000 Ω ... 9999 Ω	0.1 Ω 1 Ω 1 Ω
Line impedance (EN 61557-3)	0.00 Ω ... 9.99 Ω 10.0 Ω ... 99.9 Ω 100 Ω ... 999 Ω 1.00 kΩ ... 9.99 kΩ 10.0 kΩ ... 19.9 kΩ	0.01 Ω 0.1 Ω 1 Ω 10 Ω 100 Ω	±(5 % of reading + 5 digits)
	Voltage drop	0.0 % ... 99.9 %	0.1 %
Loop impedance (EN 61557-3)	0.00 Ω ... 9.99 Ω 10.0 Ω ... 99.9 Ω 100 Ω ... 19999 Ω	0.01 Ω 0.1 Ω 1 Ω	±(5 % of reading + 5 digits)
	Voltage	0 V ... 550 V	1 V
Frequency	0.00 Hz ... 999.99 Hz	0.01 Hz	±(0.2 % of reading + 1 digit)
Phase sequence (EN 61557-7)	1.2.3 or 3.2.1		
RCD testing (EN 61557-6)	I _{ΔN} : 10 mA, 30 mA, 100 mA, 300 mA, 500 mA, 1 A		
- Contact voltage U _c	0.0 V ... 19.9 V 20.0 V ... 99.9 V	0.1 V 0.1 V	(-0 % / +15 %) of reading ± 10 digits (-0 % / +15 %) of reading
- Trip-out time	0.0 ms ... 40.0 ms 0.0 ms ... max. time	0.1 ms 0.1 ms	±1 ms ±3 ms
	- Trip-out current	0.2 x I _{ΔN} ... 1.1 x I _{ΔN} (AC type) 0.2 x I _{ΔN} ... 1.5 x I _{ΔN} (A type, I _{ΔN} ≥ 30 mA) 0.2 x I _{ΔN} ... 2.2 x I _{ΔN} (A type, I _{ΔN} < 30 mA) 0.2 x I _{ΔN} ... 2.2 x I _{ΔN} (B type)	0.05 x I _{ΔN} 0.05 x I _{ΔN} 0.05 x I _{ΔN} 0.05 x I _{ΔN}
Earth resistance (EN 61557-5) (three-wire method)		0.00 Ω ... 19.99 Ω 20.0 Ω ... 199.9 Ω 200 Ω ... 1999 Ω 2000 Ω ... 9999 Ω	0.01 Ω 0.1 Ω 1 Ω 1 Ω
	Specific earth resistance	0.0 Ωm ... 99.9 Ωm 100 Ωm ... 999 Ωm 1.00 kΩm ... 9.99 kΩm 10.0 kΩm ... 99.9 kΩm > 100 kΩm	0.1 Ωm 1 Ωm 0.01 kΩm 0.1 kΩm 1 kΩm
Varistor Test		0 ... 625 V _{AC} ; 0 ... 1000 V _{DC}	1 V
Power supply	6 x 1.2 V rechargeable batteries, type AA		
Overvoltage category	CAT III / 600 V; CAT IV / 300 V		
Protection class	Double insulation		
COM port	RS232 and USB		
Dimensions	230 x 103 x 115 mm		
Weight	1.3 kg		

STANDARD SET:

- Instrument EurotestAT
- Plug commander, 1.5 m
- Test lead, 3 x 1.5 m
- Power supply adapter + 6 NiMH rechargeable batteries, type AA
- Test probe, 3 pcs (blue, black, green)
- Crocodile clip, 3 pcs (blue, black, green)
- RS232 - PS/2 cable
- USB cable
- Soft carrying bag
- Soft carrying neck belt
- PC Software EuroLink PRO
- Short Instruction manual
- Instruction manual on CD
- Handbook on CD
- Calibration certificate



MI 3102H BT EurotestXE 2,5 kV

MI 3102H BT EurotestXE 2,5 kV is a multifunctional measuring instrument which apart from all the necessary functions for complete installation safety testing according to IEC/EN 61557 performs insulation resistance measurement with the test voltage up to 2,5 kV (measuring range is up to 20 GΩ) and enables diagnostic test by PI and DAR indexes calculation. Besides, the MI 3102H BT EurotestXE 2,5 kV enables on-line voltage monitoring, phase sequence testing, earth resistance measurement, illuminance measurement and TRMS current measurement. EurotestXE 2,5 kV is equipped with integrated characteristics of fuses and RCDs for PASS / FAIL evaluation of test results. All the results can be quickly saved and referenced on the instrument and then downloaded via the EuroLink PRO software (included in the standard set) to the computer for evaluation and report generation after testing.

MEASURING FUNCTIONS:

- Insulation resistance with DC voltage 50 V to 2,5 kV and PI, DAR calculation;
- Continuity of PE conductors with 200 mA DC test current with polarity change;
- Continuity of PE conductors with 7 mA test current without RCD tripping;
- Continuity RPE with 200 mA AC on outlet;
- Line/Loop impedance;
- Loop impedance with Trip Lock RCD function;
- TRMS voltage and frequency;
- Phase sequence;
- Power and harmonics;
- RCD testing (general and selective, type AC, A, F);
- Earth resistance (3-wire and 2-clamps method);
- Specific earth resistance with Ro-adaptor (option);
- TRMS leakage and load currents (option);
- Illumination (option).

KEY FEATURES:

- **Predefined mini AUTO SEQUENCE®s:** Auto TT (U, Zln, Zs, Uc); Auto TN/RCD (U, Zln, Zs, Rpe); Auto TN (U, Zln, Zlpe, Rpe).
- **Insulation range:** wide range of insulation test voltages from 100 V to 2500 V, readings up to 20 GΩ.
- **Insulation diagnostics:** polarisation Index (PI) and Dielectric Absorption Ratio (DAR) calculation.
- **Power** measurements and harmonics analysis.
- **Built-in help screens** for referencing on site.
- **Built-in fuse tables** for automatic evaluation of the line / loop impedance result.
- **On-line voltage monitoring:** monitors all 3 voltages in real-time.
- **Polarity swap:** automatic polarity reversal on continuity test.



- **Trip Lock function:** loop impedance test without tripping the RCD.
- **Built-in charger** and rechargeable batteries as standard accessory.
- **RCD auto:** automated RCD testing procedure.
- **Bluetooth communication** with PC, Android tablets and smart phones via built-in BT.
- **PC SW EuroLink PRO** for downloading of test results and report creation.
- **EuroLink Android APP,** data management tool (option).

APPLICATION:

- Initial and periodic testing of domestic and industrial installations.
- Testing of Insulation resistance of transformers, motors, cables, machines, etc.
- Observation of insulation trends.
- Testing of single and multiphase systems.

- Testing of TT and TN supply systems.

STANDARDS:

- Functionality:**
IEC/EN 61557
- Other reference standards for testing:**
IEC/EN 60364;
EN 61008;
EN 61009;
EN 60755;
BS 7671;
AS/NZ 3760;
CEI 64.8;
HD 384;
VDE 413
- Electromagnetic compatibility:**
EN 61326
- Safety:**
EN 61010-1;
EN 61010-031
EN 31010-2-030
EN 31010-2-032

TECHNICAL DATA:

Function	Measuring range	Resolution	Accuracy
CONTINUITY	Test Current 7 mA 2-wire 0.00 Ω ... 19.99 Ω 20.0 Ω ... 1999 Ω	0.1 Ω 1 Ω	±(5 % of r. + 5 digits) ±(3 % of r. + 3 digits)
	Test Current 200 mA 2-wire 20.0 Ω ... 99.9 Ω 100.0 Ω ... 1999 Ω	0.1 Ω 1 Ω	±(5 % of r.) ±(5 % of r.)
INSULATION RESISTANCE	Test Voltage 50/100/250 V 0.00 MΩ ... 19.99 MΩ 20.0 MΩ ... 99.9 MΩ 100.0 MΩ ... 199.9 MΩ	0.01 MΩ 0.1 MΩ 1 MΩ	±(5 % of r. + 3 digits) ±(10 % of r.) ±(20 % of r.)
	Test Voltage 500/1000 V 0.00 MΩ ... 19.99 MΩ 20.0 MΩ ... 99.9 MΩ 200 MΩ ... 999 MΩ	0.01 MΩ 0.1 MΩ 1 MΩ	±(5 % of r. + 3 digits) ±(5 % of r.) ±(10 % of r.)
	Test Voltage 2500 V 0.00 MΩ ... 19.99 MΩ 20.0 MΩ ... 199.9 MΩ 200 MΩ ... 999 MΩ 1.00 GΩ ... 19.99 GΩ	0.01 MΩ 0.1 MΩ 0.1 MΩ 0.01 GΩ	±(5 % of r. + 3 digits) ±(5 % of r.) ±(10 % of r.) ±(10 % of r.)
INSULATION ANALYSING	Calculation of PI, DAR, DD Only for test voltage 500/1000/2500 V 10.0 MΩ ... 100 MΩ	0.01 MΩ 0.1 MΩ	±(5 % of r. + 2 digits) ±(5 % of r.)
RCD	Contact voltage 0.00 V ... 19.99 V 20.0 V ... 99.9 V	0.1 V	(0%±15%) of r. ± 10 digits (0%±15%) of r.
	Trip out time 0.00 ms ... 40.0 ms 0.0 V ... max.time	0.1 ms	±1 ms ±3 ms
IMPEDANCE	Zline L-L, L-N Ipsc 0.00 Ω ... 9.99 Ω 10.0 Ω ... 99.9 Ω 100 Ω ... 999 Ω 1.00 kΩ ... 9.99 kΩ	0.01 Ω 0.1 Ω 1 Ω 10 Ω	±(5 % of r. + 5 digits) ±(10 % of r.)
	Zloop L-PE, Ipfcc 0.00 Ω ... 9.99 Ω 10.0 Ω ... 99.9 Ω 100 Ω ... 999 Ω 1.00 kΩ ... 9.99 kΩ	0.01 Ω 0.1 Ω 1 Ω 10 Ω	±(5 % of r. + 5 digits) ±(10 % of r.)
VOLTAGE	TRMS 0 ... 550 V	1 V	±(2 % of r. + 2 digits)
	Frequency 0.00 Hz ... 9.99 Hz 10.0 Hz ... 499.9 Hz	0.01 Hz 0.1 Hz	±(0.2 % of r. + 1 digits)
CURRENT	TRMS, AC with A 1018 0.0 mA ... 99.9 mA 100 mA ... 999 mA 1.00 A ... 19.99 A	0.1 mA 1 mA 0.01 A	±(5 % of r. + 5 digits) ±(3 % of r. + 3 digits) ±(3 % of r.)
	TRMS, AC with A 1019 0.0 mA ... 99.9 mA 100 mA ... 999 mA 1.00 A ... 19.99 A	0.1 mA 1 mA 0.01 A	indicative ±(5 % of r.) ±(3 % of r.)
	TRMS, AC/DC with A 1391, range=40A 0.00 A ... 1.99 A 2.00 A ... 19.99 A 20.0 A ... 39.9 A	0.01 A 0.01 A 0.1 A	±(3 % of r. + 3 digits) ±(3 % of r.)
	TRMS, AC/DC with A 1391, range = 300A 0.00 A ... 19.99 A 20.0 A ... 39.9 A 40.0 A ... 299.9 A	0.01 A 0.1 A 0.1 A	indicative ±(3 % of r. + 5 digits)
EARTH RESISTANCE	3 wire 0.00 MΩ ... 19.99 Ω 20.0 MΩ ... 199.9 Ω 200.0 MΩ ... 9999 Ω	0.01 Ω 0.1 Ω 1 Ω	±(5 % of r. + 5 digits)
	2 clamp 0.00 MΩ ... 19.99 Ω 20.0 MΩ ... 30.0 Ω 30.1 MΩ ... 99.9 Ω	0.01 Ω 0.1 Ω 0.1 Ω	±(10 % of r. + 10 digits) ±(20 % of r.) ±(30 % of r.)
	Specific earth resistance 0.0 Ωm ... 99.9 Ωm 100 Ωm ... 999 Ωm 1.00 Ωmk ... 9.99 kΩmk 10.0 Ωmk ... 99.9 kΩmk	0.1 Ωm 1 Ωm 0.01 kΩmk 0.1 kΩmk	±(5 % of r.) for Re 1 Ω ... 1999kΩ ±(10 % of r.) for Re 2 kΩ ... 199.9kΩ ±(20 % of r.) for Re > 20 kΩ
ILLUMI-NANCE	Type B 0.01 lux ... 19.99 lux 20.0 lux ... 199.9 lux 200 lux ... 1999 lux 2.00 klux ... 19.99 klux	0.01 lux 0.1 lux 1 lux 10 lux	±(5 % of r.)
	Type C 0.01 lux ... 19.99 lux 20.0 lux ... 199.9 lux 200 lux ... 1999 lux 2.00 klux ... 19.99 klux	0.01 lux 0.1 lux 1 lux 10 lux	±(10 % of r. + 3 digits) ±(10 % of r.)
GENERAL	Power supply 9 VDC (6x1.5 V battery or accu. size AA)		
	Overvoltage category CAT II / 1000 V _{DC} ; CAT III / 600 V; CAT IV / 300 V		
	Protection class Double insulation		
	COM port BT, USB, RS232		
	Weight 1.3 kg		
	Size (L x H x W) 230 x 103 x 115 mm		

STANDARD SET:

- Instrument EurotestXE 2,5 kV
- Plug commander, 1.5 m
- 2.5 kV test lead, 2 x 1.5 m
- Test lead, 3 x 1.5 m
- Earth test set, 3-wire, 20 m (test lead, 4 m; 2 x test lead, 20 m; 2 x test rod)
- Power supply adapter + 6 NiMH rechargeable batteries, size AA
- PC Software EuroLink PRO
- Test probe, 3 pcs (blue, black, green)
- Crocodile clip, 3 pcs (blue, black, green)
- RS232 - PS/2 cable
- USB cable
- Soft carrying neck belt
- Soft carrying bag
- Short instruction manual
- Instruction manual on CD
- Handbook on CD
- Calibration certificate



MI 3102 BT EurotestXE

MI 3102 BT EurotestXE is a multifunctional measuring instrument which performs a complete set of installation safety tests according to IEC/EN 61557. It supports **AUTO SEQUENCE**® testing of the TN, TT and IT earthing systems. ISFL measurements and the IMD tests can be performed. Besides, the MI 3102 BT EurotestXE enables on-line voltage monitoring, phase sequence testing, earth resistance measurement, illuminance measurement and TRMS current measurement. EurotestXE is equipped with integrated characteristics of fuses and RCDs for PASS / FAIL evaluation of test results. All the results can be quickly saved and referenced on the instrument and then downloaded via the EuroLink PRO software (included in the standard set) to the computer for evaluation and report generation after testing.

MEASURING FUNCTIONS:

- Insulation resistance with DC voltage from 50 V to 1000 V;
- Continuity of PE conductors with 200 mA DC test current with polarity change;
- Continuity of PE conductors with 7 mA test current without RCD tripping;
- Line/Loop impedance;
- Loop impedance with Trip Lock RCD function;
- TRMS voltage and frequency;
- Phase sequence;
- Power and harmonics;
- RCD testing (general and selective, type AC, A, F, B, B+);
- Earth resistance (3-wire and 2-clamps method);
- Specific earth resistance with Ro-adaptor (option);
- TRMS leakage and load currents (option);
- First fault leakage current (ISFL);
- Testing of Insulation Monitoring Devices (IMDs);
- Illumination (option).

KEY FEATURES:

- **Predefined mini AUTO SEQUENCE**®s: Auto TT (U, Zln, Zs, Uc); Auto TN/RCD (U, Zln, Zs, Rpe); Auto TN (U, Zln, Zlpe, Rpe); Auto IT (U, Zln, Isc, Isfl, IMD).
- **Power** measurements and harmonics analysis.
- **Built-in help screens** for referencing on site.
- **Built-in fuse tables** for automatic evaluation of the line / loop impedance result.
- **On-line voltage monitoring:** monitors all 3 voltages in real-time.
- **Polarity swap:** automatic polarity reversal on continuity test.
- **Trip Lock function:** loop impedance test without tripping the RCD.



- **Built-in charger** and rechargeable batteries as standard accessory.
- **RCD auto:** automated RCD testing procedure.
- **Bluetooth communication** with PC, Android tablets and smart phones via built-in BT.
- **PC SW EuroLink PRO** for downloading of test results and report creation.
- **EuroLink Android APP,** data management tool (option).

APPLICATION:

- Initial and periodic testing of domestic and industrial installations.
- Testing of single and multiphase systems.
- Testing of TT, TN and IT earthing systems.
- Medical installation testing.

STANDARDS:

- Functionality:**
EN 61557
DIN 5032
- Other reference standards for testing:**
IEC/EN 60364-4-41;
EN 61008;
EN 61009;
BS 7671;
AS/NZ 3017;
CEI 64.8;
HD 384;
VDE 413
- Electromagnetic compatibility:**
EN 61326
- Safety:**
EN 61010-1;
EN 61010-031
EN 31010-2-030
EN 31010-2-032

TECHNICAL DATA:

Function	Measuring range	Resolution	Accuracy
CONTINUITY	Test Current 7 mA 2-wire 0.00 Ω ... 19.99 Ω 20.0 Ω ... 1999 Ω	0.1 Ω 1 Ω	±(5 % of r. + 5 digits)
	Test Current 200 mA 2-wire 0.00 Ω ... 19.99 Ω 20.0 Ω ... 99.9 Ω 100.0 Ω ... 1999 Ω	0.01 Ω 0.1 Ω 1 Ω	±(3 % of r. + 3 digits) ±(5 % of r.) ±(5 % of r.)
INSULATION RESISTANCE	Test Voltage 50/100/250 V 0.00 MΩ ... 19.99 MΩ 20.0 MΩ ... 99.9 MΩ 100.0 MΩ ... 199.9 MΩ	0.01 MΩ 0.1 MΩ	±(5 % of r. + 3 digits) ±(10 % of r.) ±(20 % of r.)
	Test Voltage 500/1000 V 0.00 MΩ ... 19.99 MΩ 20.0 MΩ ... 99.9 MΩ 200 MΩ ... 999 MΩ	0.01 MΩ 0.1 MΩ 1 MΩ	±(5 % of r. + 3 digits) ±(5 % of r.) ±(10 % of r.)
RCD	Contact voltage 0.00 V ... 19.99 V 20.0 V ... 99.9 V	0.1 V	(-0%/±15 %) of r. ± 10 digits (-0%/±15 %) of r.
	Trip out time 0.00 ms ... 40.0 ms 0.0 V ... max.time	0.1 ms	±1 ms ±3 ms
	Trip out current 0.2xI _{AN} ... 1.1xI _{AN} (AC) 0.2xI _{AN} ... 1.5xI _{AN} (A) I _{AN} <30 mA 0.2xI _{AN} ... 2.2xI _{AN} (A) I _{AN} <30 mA	0.05xI _{AN}	±0.1 I _{AN}
IMPEDANCE	Zline L-L, L-N Ip _{sc} 0.00 Ω ... 9.99 Ω 10.0 Ω ... 99.9 Ω 100 Ω ... 999 Ω 1.00 kΩ ... 9.99 kΩ	0.01 Ω 0.1 Ω 1 Ω 10 Ω	±(5 % of r. + 5 digits) ±(10 % of r.)
	Zloop L-PE, Ip _{fc} 0.00 Ω ... 9.99 Ω 10.0 Ω ... 99.9 Ω 100 Ω ... 999 Ω 1.00 kΩ ... 9.99 kΩ	0.01 Ω 0.1 Ω 1 Ω 10 Ω	±(5 % of r. + 5 digits) ±(10 % of r.)
VOLTAGE	TRMS 0 ... 550 V	1 V	±(2 % of r. + 2 digits)
	Frequency 0.00 Hz ... 9.99 Hz 10.0 Hz ... 499.9 Hz	0.01 Hz 0.1 Hz	±(0.2 % of r. + 1 digits)
CURRENT	TRMS, AC with A 1018 0.0 mA ... 99.9 mA 100 mA ... 999 mA 1.00 A ... 19.99 A	0.1 mA 1 mA 0.01 A	±(5 % of r. + 5 digits) ±(3 % of r. + 3 digits) ±(3 % of r.)
	TRMS, AC with A 1019 0.0 mA ... 99.9 mA 100 mA ... 999 mA 1.00 A ... 19.99 A	0.1 mA 1 mA 0.01 A	indicative ±(5 % of r.) ±(3 % of r.)
	TRMS, AC/DC with A 1391, range=40A 0.00 A ... 1.99 A 2.00 A ... 19.99 A 20.0 A ... 39.9 A	0.01 A 0.01 A 0.1 A	±(3 % of r. + 3 digits) ±(3 % of r.) ±(3 % of r.)
	TRMS, AC/DC with A 1391, range = 300A 0.00 A ... 19.99 A 20.0 A ... 39.9 A 40.0 A ... 299.9 A	0.01 A 0.1 A 0.1 A	indicative ±(3 % of r. + 5 digits)
EARTH RESISTANCE	3 wire 0.00 MΩ ... 19.99 Ω 20.0 MΩ ... 199.9 Ω 200.0 MΩ ... 9999 Ω	0.01 Ω 0.1 Ω 1 Ω	±(5 % of r. + 5 digits)
	2 clamp 0.00 MΩ ... 19.99 Ω 20.0 MΩ ... 30.0 Ω 30.1 MΩ ... 99.9 Ω	0.01 Ω 0.1 Ω 0.1 Ω	±(10 % of r. + 10 digits) ±(20 % of r.) ±(30 % of r.)
	Specific earth resistance 0.0 Ωm ... 99.9 Ωm 100 Ωm ... 999 Ωm 1.00 kΩm ... 9.99 kΩm 10.0 kΩm ... 99.9 kΩm	0.1 Ωm 1 Ωm 0.01 kΩm 0.1 kΩm	±(5 % of r.) for Re 1 Ω ... 1999kΩ ±(10 % of r.) for Re 2 kΩ ... 19.99kΩ ±(20 % of r.) for Re > 20 kΩ
ILLUMI-NANCE	Type B 0.01 lux ... 19.99 lux 20.0 lux ... 199.9 lux 200 lux ... 1999 lux 2.00 klux ... 19.99 klux	0.01 lux 0.1 lux 1 lux 10 lux	±(5 % of r. + 2 digits)
	Type C 0.01 lux ... 19.99 lux 20.0 lux ... 199.9 lux 200 lux ... 1999 lux 2.00 klux ... 19.99 klux	0.01 lux 0.1 lux 1 lux 10 lux	±(10 % of r. + 3 digits) ±(10 % of r.)
GENERAL	Power supply	9 VDC (6x1.5 V battery or accu. size AA)	
	Overvoltage category	CAT II / 1000 V _{DC} ; CAT III / 600 V; CAT IV / 300 V	
	Protection class	Double insulation	
	COM port	BT, USB, RS232	
	Weight	1.3 kg	
Size (l x h x w)	230 x 103 x 115 mm		

STANDARD SET:

- Instrument EurotestXE
- Plug commander, 1.5 m
- Test lead, 3 x 1.5 m
- Earth test set, 3-wire, 20 m (test lead, 4 m; 2 x test lead, 20 m; 2 x test rod)
- Power supply adapter + 6 NiMH rechargeable batteries, size AA
- PC Software EuroLink PRO
- Test probe, 3 pcs (blue, black, green)
- Crocodile clip, 3 pcs (blue, black, green)
- RS232 - PS/2 cable
- USB cable
- Soft carrying neck belt
- Soft carrying bag
- Short instruction manual
- Instruction manual on CD
- Handbook on CD
- Calibration certificate



MI 3100 SE EurotestEASI

MI 3100 SE EurotestEASI is a fast, accurate and easy to use multifunctional measuring instrument which performs a complete set of installation safety tests according to IEC/EN 61557. Besides, the MI 3100 SE EurotestEASI enables on-line voltage monitoring, phase sequence testing and earth resistance measurement. EurotestEASI is equipped with integrated characteristics of fuses and RCDs for PASS / FAIL evaluation of test results. All the results can be quickly saved and referenced on the instrument and then downloaded via the EuroLink PRO software (included in the standard set) to the computer for evaluation and report generation after testing.

MEASURING FUNCTIONS:

- Insulation resistance with DC voltage from 50 V to 1000 V;
- Continuity of PE conductors with 200 mA test current with polarity change;
- Continuity of PE conductors with 7 mA test current without RCD tripping;
- Line impedance;
- Loop impedance;
- Loop impedance with Trip Lock RCD function;
- TRMS voltage and frequency;
- Phase sequence;
- RCD testing (general and selective, type AC, A, F);
- Earth resistance (3-wire method).

KEY FEATURES:

- **Predefined mini AUTO SEQUENCE®s:** Auto TT (U, Zln, Zs, Uc); Auto TN/RCD (U, Zln, Zs, Rpe); Auto TN (U, Zln, Zlpe, Rpe).
- **Built-in help screens** for referencing on site.
- **Built-in fuse tables** for automatic evaluation of the line / loop impedance result.
- **On-line voltage monitoring:** monitors all 3 voltages in real-time.
- **Polarity swap:** automatic polarity reversal on continuity test.
- **Trip Lock function:** loop impedance test without tripping the RCD.
- **Built-in charger** and rechargeable batteries as standard accessory.
- **RCD auto:** automated RCD testing procedure.
- **Bluetooth communication** with PC, Android tablets and smart phones via built-in BT.
- **PC SW EuroLink PRO** for downloading of test results and report creation.



- **EuroLink Android APP,** data management tool (option).

APPLICATION:

- Initial and periodic testing of domestic and industrial installations.
- Testing of single and multiphase systems.
- Testing of TT and TN supply systems.

STANDARDS:

Functionality:
IEC/EN 61557

Other reference standards for testing:
IEC/EN 60364-4-41;

EN 61008;
EN 61009;
BS 7671;
AS/NZ 3017;

Electromagnetic compatibility:
EN 61326

Safety:
EN 61010-1;
EN 61010-031
EN 31010-2-030
EN 31010-2-032

TECHNICAL DATA:

Function	Measuring range	Resolution	Accuracy
CONTINUITY	Test Current 7 mA 2-wire 0.00 Ω ... 19.99 Ω 20.0 Ω ... 1999 Ω	0.1 Ω 1 Ω	±(5 % of r. + 5 digits)
	Test Current 200 mA 2-wire 0.00 Ω ... 19.99 Ω 20.0 Ω ... 99.9 Ω 100.0 Ω ... 1999 Ω	0.01 Ω 0.1 Ω 1 Ω	±(3 % of r. + 3 digits) ±(5 % of r.) ±(5 % of r.)
INSULATION RESISTANCE	Test Voltage 50/100/250 V 0.00 MΩ ... 19.99 MΩ 20.0 MΩ ... 99.9 MΩ 100.0 MΩ ... 199.9 MΩ	0.01 MΩ 0.1 MΩ	±(5 % of r. + 3 digits) ±(10 % of r.) ±(20 % of r.)
	Test Voltage 500/1000 V 0.00 MΩ ... 19.99 MΩ 20.0 MΩ ... 99.9 MΩ 200 MΩ ... 999 MΩ	0.01 MΩ 0.1 MΩ 1 MΩ	±(5 % of r. + 3 digits) ±(5 % of r.) ±(10 % of r.)
RCD	Contact voltage 0.00 V ... 19.99 V 20.0 V ... 99.9 V	0.1 V	(-0%/±15 %) of r. ± 10 digits (-0%/±15 %) of r.
	Trip out time 0.00 ms ... 40.0 ms 0.0 V ... max.time	0.1 ms	±1 ms ±3 ms
	Trip out current 0.2xI _{AN} ... 1.1xI _{AN} (AC) 0.2xI _{AN} ... 1.5xI _{AN} (A) I _{AN} <30 mA) 0.2xI _{AN} ... 2.2xI _{AN} (A) I _{AN} <30 mA)	0.05xI _{AN}	±0.1 I _{AN}
IMPEDANCE	Zline L-L, L-N Ip _{sc} 0.00 Ω ... 9.99 Ω 10.0 Ω ... 99.9 Ω 100 Ω ... 999 Ω 1.00 kΩ ... 9.99 kΩ	0.01 Ω 0.1 Ω 1 Ω 10 Ω	±(5 % of r. + 5 digits) ±(10 % of r.)
	Zloop L-PE, Ip _{fc} 0.00 Ω ... 9.99 Ω 10.0 Ω ... 99.9 Ω 100 Ω ... 999 Ω 1.00 kΩ ... 9.99 kΩ	0.01 Ω 0.1 Ω 1 Ω 10 Ω	±(5 % of r. + 5 digits) ±(10 % of r.)
VOLTAGE	TRMS 0 ... 550 V	1 V	±(2 % of r. + 2 digits)
	Frequency 0.00 Hz ... 9.99 Hz 10.0 Hz ... 499.9 Hz	0.01 Hz 0.1 Hz	±(0.2 % of r. + 1 digits)
EARTH RESISTANCE	3 wire 0.00 MΩ ... 19.99 Ω 20.0 MΩ ... 199.9 Ω 200.0 MΩ ... 9999 Ω	0.01 Ω 0.1 Ω 1 Ω	±(5 % of r. + 5 digits)
	2 clamp 0.00 MΩ ... 19.99 Ω 20.0 MΩ ... 30.0 Ω 30.1 MΩ ... 99.9 Ω	0.01 Ω 0.1 Ω 0.1 Ω	±(10 % of r. + 10 digits) ±(20 % of r.) ±(30 % of r.)
	Specific earth resistance 0.0 Ωm ... 99.9 Ωm 100 Ωm ... 999 Ωm 1.00 Ωmk ... 9.99 kΩm 10.0 Ωmk ... 99.9 kΩm	0.1 Ωm 1 Ωm 0.01 kΩm 0.1 kΩm	±(5 % of r.) for Re 1 Ω ... 1999kΩ ±(10 % of r.) for Re 2 kΩ ... 19.99kΩ ±(20 % of r.) for Re > 20 kΩ
GENERAL	Power supply	9 VDC (6x1.5 V battery or accu, size AA)	
	Overvoltage category	CAT II / 1000 V _{dc} ; CAT III / 600 V; CAT IV / 300 V	
	Protection class	Double insulation	
	COM port	BT, USB, RS232	
	Weight Size (l x h x w)	1.3 kg 230 x 103 x 115 mm	

STANDARD SET:

- Instrument EurotestEASI
- Schuko-plug test cable, 1.5 m
- Test lead, 3 x 1.5 m
- Test probe, 3 pcs (blue, black, green)
- Crocodile clip, 3 pcs (blue, black, green)
- Power supply adapter + 6 NiMH rechargeable batteries, size AA
- RS232 - PS/2 cable
- USB cable
- Soft carrying neck belt
- Soft carrying bag
- PC Software EuroLink PRO
- Short instruction manual
- Instruction manual on CD
- Handbook on CD
- Calibration certificate



MI 3100 s EurotestEASI

MI 3100 s EurotestEASI is a fast, accurate and easy to use multifunctional measuring instrument which performs a basic set of installation safety tests according to IEC/EN 61557. Besides, the MI 3100 s EurotestEASI enables on-line voltage monitoring, phase sequence testing and earth resistance measurement. EurotestEASI is equipped with integrated characteristics of fuses and RCDs for PASS / FAIL evaluation of test results.

MEASURING FUNCTIONS:

- Insulation resistance with DC voltage from 50 V to 1000 V;
- Continuity of PE conductors with 200 mA test current with polarity change;
- Continuity of PE conductors with 7 mA test current without RCD tripping;
- Line impedance;
- Loop impedance;
- Loop impedance with Trip Lock RCD function;
- TRMS voltage and frequency;
- Phase sequence;
- RCD testing (general and selective, type AC, A, F);
- Earth resistance (3-wire method).

KEY FEATURES:

- **Built-in help screens** for referencing on site.
- **Built-in fuse tables** for automatic evaluation of the line / loop impedance result.
- **On-line voltage monitoring:** monitors all 3 voltages in real-time.
- **Polarity swap:** automatic polarity reversal on continuity test.
- **Trip Lock function:** loop impedance test without tripping the RCD.
- **Built-in charger** and rechargeable batteries as standard accessory.
- **RCD auto:** automated RCD testing procedure.

APPLICATION:

- Initial and periodic testing of domestic and industrial installations.
- Testing of single and multiphase systems.
- Testing of TT and TN supply systems.



STANDARDS:

Functionality:

IEC/EN 61557

Other reference standards for testing:

IEC/EN 60364-4-41; EN 61008; EN 61009; BS 7671; AS/NZ 3017

Electromagnetic compatibility:

EN 61326

Safety:

EN 61010-1; EN 61010-031; EN 31010-2-030; EN 31010-2-032

STANDARD SET:

- Instrument EurotestEASI
- Schuko-plug test cable, 1.5 m
- Test lead, 3 x 1.5 m
- Test probe, 3 pcs (blue, black, green)
- Crocodile clip, 3 pcs (blue, black, green)
- Power supply adapter + 6 NiMH rechargeable batteries, size AA
- Soft carrying neck belt
- Soft carrying bag
- Short instruction manual
- Instruction manual on CD
- Handbook on CD
- Calibration certificate



TECHNICAL DATA:

Function	Measuring range	Resolution	Accuracy
CONTINUITY	Test Current 7 mA 2-wire 0.00 Ω ... 19.99 Ω 20.0 Ω ... 1999 Ω	0.1 Ω 1 Ω	±(5 % of r. + 5 digits)
	Test Current 200 mA 2-wire 0.00 Ω ... 19.99 Ω 20.0 Ω ... 99.9 Ω 100.0 Ω ... 1999 Ω	0.01 Ω 0.1 Ω 1 Ω	±(3 % of r. + 3 digits) ±(5 % of r.) ±(5 % of r.)
INSULATION RESISTANCE	Test Voltage 50/100/250 V 0.00 MΩ ... 19.99 MΩ 20.0 MΩ ... 99.9 MΩ 100.0 MΩ ... 199.9 MΩ	0.01 MΩ 0.1 MΩ	±(5 % of r. + 3 digits) ±(10 % of r.) ±(20 % of r.)
	Test Voltage 500/1000 V 0.00 MΩ ... 19.99 MΩ 20.0 MΩ ... 99.9 MΩ 200 MΩ ... 999 MΩ	0.01 MΩ 0.1 MΩ 1 MΩ	±(5 % of r. + 3 digits) ±(5 % of r.) ±(10 % of r.)
RCD	Contact voltage 0.00 V ... 19.99 V 20.0 V ... 99.9 V	0.1 V	(-0%/±15 %) of r. ± 10 digits (-0%/±15 %) of r.
	Trip out time 0.00 ms ... 40.0 ms 0.0 V ... max.time	0.1 ms	±1 ms ±3 ms
	Trip out current 0.2xI _{AN} ... 1.1xI _{AN} (AC) 0.2xI _{AN} ... 1.5xI _{AN} (A) I _{AN} <30 mA 0.2xI _{AN} ... 2.2xI _{AN} (A) I _{AN} <30 mA	0.05xI _{AN}	±0.1 I _{AN}
IMPEDANCE	Zline L-L, L-N Ip _{sc} 0.00 Ω ... 9.99 Ω 10.0 Ω ... 99.9 Ω 100 Ω ... 999 Ω 1.00 kΩ ... 9.99 kΩ	0.01 Ω 0.1 Ω 1 Ω 10 Ω	±(5 % of r. + 5 digits) ±(10 % of r.)
	Zloop L-PE, Ip _{fc} 0.00 Ω ... 9.99 Ω 10.0 Ω ... 99.9 Ω 100 Ω ... 999 Ω 1.00 kΩ ... 9.99 kΩ	0.01 Ω 0.1 Ω 1 Ω 10 Ω	±(5 % of r. + 5 digits) ±(10 % of r.)
VOLTAGE	TRMS 0 ... 550 V	1 V	±(2 % of r. + 2 digits)
	Frequency 0.00 Hz ... 9.99 Hz 10.0 Hz ... 499.9 Hz	0.01 Hz 0.1 Hz	±(0.2 % of r. + 1 digits)
EARTH RESISTANCE	3 wire 0.00 MΩ ... 19.99 Ω 20.0 MΩ ... 199.9 Ω 200.0 MΩ ... 9999 Ω	0.01 Ω 0.1 Ω 1 Ω	±(5 % of r. + 5 digits)
	2 clamp 0.00 MΩ ... 19.99 Ω 20.0 MΩ ... 30.0 Ω 30.1 MΩ ... 99.9 Ω	0.01 Ω 0.1 Ω 0.1 Ω	±(10 % of r. + 10 digits) ±(20 % of r.) ±(30 % of r.)
	Specific earth resistance 0.0 Ωm ... 99.9 Ωm 100 Ωm ... 999 Ωm 1.00 Ωmk ... 9.99 kΩm 10.0 Ωmk ... 99.9 kΩm	0.1 Ωm 1 Ωm 0.01 kΩm 0.1 kΩm	±(5 % of r.) for Re 1 Ω ... 1999kΩ ±(10 % of r.) for Re 2 kΩ ... 19.99kΩ ±(20 % of r.) for Re > 20 kΩ
GENERAL	Power supply	9 VDC (6x1.5 V battery or accu, size AA)	
	Overvoltage category	CAT II / 1000 V _{DC} ; CAT III / 600 V; CAT IV / 300 V	
	Protection class	Double insulation	
	COM port	BT, USB, RS232	
	Weight Size (l x h x w)	1.3 kg 230 x 103 x 115 mm	

MI 3125BT EurotestCOMBO

The MI 3125BT EurotestCOMBO performs all the necessary tests for installation safety testing on TT and TN systems. The large graphic display with backlight offers easy reading of results, indications, measurement parameters and messages. Two LED Pass/Fail indicators are placed on both sides of the LCD. MI 3125BT EurotestCOMBO contains integrated characteristics of fuses and RCDs (including B type) for the evaluation of test results. Each test has its own individual help screen describing how to connect the instrument into the installation and how to perform a measurement. All the results can be quickly saved and referenced on the instrument and then downloaded via the EuroLink PRO software, included in the standard set, to the computer for evaluation and report generation after testing. MI 3125BT EurotestCOMBO performs continuity, insulation, RCD, loop, line, voltage, frequency, earth resistance testing and phase sequence tests required by the EN 61557 standard.

MEASURING FUNCTIONS:

- Insulation resistance with DC voltage;
- Continuity of PE conductors with 200 mA test current with polarity change;
- Continuity of PE conductors with 7 mA test current (continuous measurement) without RCD tripping;
- Line impedance;
- Loop impedance;
- Loop impedance with Trip Lock RCD function;
- TRMS voltage and frequency;
- Phase sequence;
- RCD testing (general and selective, type AC, A and B);
- Earth resistance (3-wire method).

KEY FEATURES:

- **LED Pass/Fail indicators:** two LED indicators for PASS / FAIL evaluation of test results are placed on both sides of the LCD
- **Help screens:** instrument comes complete with built-in help screens for referencing on site.
- **Earth resistance measurement:** instrument performs 3-wire earth resistance testing with two additional rods.
- **Built-in fuse tables:** this unique feature allows automatic evaluation of the line / loop impedance compared to the regulations.
- **Online voltage monitoring:** monitors all 3 voltages in real-time.
- **Upgradeable:** if changes occur to the regulations, upgrades can be made to the firmware to keep the instrument up to date.
- **Polarity swap:** automatic polarity reversal on continuity test.
- **Insulation range:** wide range of insulation test voltages from 50 V to 1000 V, reading up to 1000 MΩ.



- **Trip Lock function:** Zs (RCD) function performs a loop impedance test without tripping the RCD.
- **Multi-system testing:** tests on single and multiphase TT and TN systems.
- **Built-in charger & rechargeable batteries:** unit has a built-in charging circuit and comes complete with a set of rechargeable NiMH batteries.
- **RCD auto:** automated RCD testing procedure significantly reduces test time.
- **B type RCD testing** is supported.
- **BT connectivity:** it enables BT communication with Android tablets and smart phones via built-in BT.
- **PC SW EuroLink PRO** included in the the standard set enables downloading of test results and parameters and creation of test reports.

APPLICATION:

- Initial and periodic testing of domestic and industrial installations;
- Testing of single and multiphase systems;
- Testing of TT and TN systems.

STANDARDS:

Functionality: IEC/EN 61557
Other reference standards for testing: VDE 0413; IEC/EN 61008; IEC/EN 61009; IEC/EN/HD 60364; HD 384; BS 7671; IEC/TR 60755; CEI 64.8; AS/NZ 3760; AS/NZ 3018
Electromagnetic compatibility: IEC/EN 61326-1; IEC/EN 61326-2-2
Safety: IEC/EN 61010-1; IEC/EN 61010-031

TECHNICAL DATA:

Function	Measuring range	Resolution	Accuracy
Insulation resistance (EN 61557-2)	U = 50, 100, 250 V _{DC} : R: 0.00 MΩ ... 19.99 MΩ 20.0 MΩ ... 99.9 MΩ 100.0 MΩ ... 199.9 MΩ	0.01 MΩ 0.1 MΩ 0.1 MΩ	±(5 % of reading + 3 digits) ±10 % of reading ±20 % of reading
	U = 500 V _{DC} , 1 kV _{DC} : R: 0.00 MΩ ... 19.99 MΩ 20.0 MΩ ... 99.9 MΩ 200 MΩ ... 999 MΩ	0.01 MΩ 0.1 MΩ 1 MΩ	±(5 % of reading + 3 digits) ±5 % of reading ±10 % of reading
Continuity 200 mA of PE conductor with polarity change (EN 61557-4)	0.00 Ω ... 19.99 Ω 20.0 Ω ... 199.9 Ω 200 Ω ... 1999 Ω	0.01 Ω 0.1 Ω 1 Ω	±(3 % of reading + 3 digits) ±5 % of reading ±5 % of reading
	Low resistance continuity measurement, test current 7 mA (Continuous measurement)	0.0 Ω ... 19.9 Ω 20 Ω ... 1999 Ω	0.1 Ω 1 Ω
Loop impedance (EN 61557-3)	0.00 Ω ... 9.99 Ω 10.0 Ω ... 99.9 Ω 100 Ω ... 999 Ω 1.00 kΩ ... 9.99 kΩ	0.01 Ω 0.1 Ω 1 Ω 10 Ω	±(5 % of reading + 5 digits) ±(5 % of reading + 5 digits) ±10 % of reading ±10 % of reading
	Line impedance (EN 61557-3)	0.00 Ω ... 9.99 Ω 10.0 Ω ... 99.9 Ω 100 Ω ... 999 Ω 1.00 kΩ ... 9.99 kΩ	0.01 Ω 0.1 Ω 1 Ω 10 Ω
Voltage drop	0.0 % ... 99.9 %	0.1 %	Consider accuracy of line impedance
Voltage	0 V ... 550 V	1 V	±(2 % of reading + 2 digits)
Frequency	0.00 Hz ... 9.99 Hz 10.0 Hz ... 499.9 Hz	0.01 Hz 0.1 Hz	±(0.2 % of reading + 1 digits)
Phase sequence (EN 61557-7)	1.2.3 or 3.2.1		
RCD testing (EN 61557-6)	I _{ΔN} : 10 mA, 30 mA, 100 mA, 300 mA, 500 mA, 1 A		
- Contact voltage U _c	0.0 V ... 19.9 V 20.0 V ... 99.9 V	0.1 V 0.1 V	(-0 % / +15 %) of reading ±10 digits (-0 % / +15 %) of reading
- Trip-out time	0 ms ... 40.0 ms 0 ms ... max. time	0.1 ms 0.1 ms	±1 ms ±3 ms
- Trip-out current	0.2 x I _{ΔN} ... 1.1 x I _{ΔN} (AC type) 0.2 x I _{ΔN} ... 2.2 x I _{ΔN} (A type, I _{ΔN} < 30 mA) 0.2 x I _{ΔN} ... 1.5 x I _{ΔN} (A type, I _{ΔN} ≥ 30 mA) 0.2 x I _{ΔN} ... 2.2 x I _{ΔN} (B type)	0.05 x I _{ΔN} 0.05 x I _{ΔN} 0.05 x I _{ΔN} 0.05 x I _{ΔN}	±0.1 x I _{ΔN} ±0.1 x I _{ΔN} ±0.1 x I _{ΔN} ±0.1 x I _{ΔN}
Earth resistance (EN 61557-5)	0.00 Ω ... 19.99 Ω 20.0 Ω ... 199.9 Ω 200 Ω ... 9999 Ω	0.01 Ω 0.1 Ω 1 Ω	±(5 % of reading + 5 digits) ±(5 % of reading + 5 digits) ±(5 % of reading + 5 digits)
	Power supply	6 x 1.2 V rechargeable batteries, type AA	
Overvoltage category	CAT III / 600 V; CAT IV / 300 V		
Protection class	Double insulation		
COM port	RS232 and USB		
Dimensions	140 x 80 x 230 mm		
Weight	1.0 kg		

STANDARD SET:

- Instrument EurotestCOMBO
- Set of carrying straps
- Test lead, 3 x 1.5 m
- Schuko-plug test cable, 1.5 m
- Test probe, 3 pcs (blue, black, green)
- Crocodile clip, 3 pcs (blue, black, green)
- Power supply adapter + 6 NiMH rechargeable batteries, type AA
- USB cable
- RS232 - PS/2 cable
- PC SW EuroLink PRO
- Short instruction manual
- Instruction manual and handbook on CD
- Calibration certificate



MI 3125 EurotestCOMBO

The MI 3125 EurotestCOMBO is the appropriate instrument for the installation safety testing on TT and TN systems. The large graphic display with backlight offers easy reading of results, indications, measurement parameters and messages. Two LED Pass / Fail indicators are placed on both sides of the LCD. EurotestCOMBO contains integrated characteristics of fuses and RCDs for the evaluation of test results. The handling of the instrument is designed to be as simple and clear as possible. Each test has its own individual help screen describing how to connect the instrument into the installation and how to perform a measurement. MI 3125 EurotestCOMBO performs continuity, insulation, RCD, loop, line, voltage, frequency and phase sequence tests required by the EN 61557 standard.

MEASURING FUNCTIONS:

- Insulation resistance with DC voltage;
- Continuity of PE conductors with 200 mA test current with polarity change;
- Line impedance;
- Loop impedance;
- Loop impedance with Trip Lock RCD function;
- TRMS voltage and frequency;
- Phase sequence;
- RCD testing (general and selective, type AC, A).
- Earth resistance (3-wire method).

KEY FEATURES:

- **LED Pass/Fail indicators:** two LED indicators for PASS / FAIL evaluation of test results are placed on both sides of the LCD.
- **Help screens:** instrument comes complete with built-in help screens for referencing on site.
- **Earth resistance measurement:** instrument performs 3-wire earth resistance testing with two additional rods.
- **Built-in fuse tables:** this unique feature allows automatic evaluation of the line / loop impedance compared to the regulations.
- **Online voltage monitoring:** monitors all 3 voltages in real-time.
- **Upgradeable:** if changes occur to the regulations, upgrades can be made to the firmware to keep the unit up to date.
- **Polarity swap:** automatic polarity reversal on continuity test.
- **Insulation range:** wide range of insulation test voltages from 50 V to 1000 V, reading up to 1000 MΩ.
- **Trip Lock function:** Zs (RCD) function performs a loop impedance test without tripping the RCD.
- **Multi-system testing:** tests on single



and multiphase TT and TN systems.

- **Built-in charger & rechargeable batteries:** unit has a built-in charging circuit and comes complete with a set of rechargeable NiMH batteries.
- **RCD auto:** automated RCD testing procedure significantly reduces test time.

APPLICATION:

- Initial and periodic testing of domestic and industrial installations;
- Testing of single and multiphase systems;

- Testing of TT and TN systems.

STANDARDS:

Functionality: IEC/EN 61557
Other reference standards for testing: VDE 0413; IEC/EN 61008; IEC/EN 61009; IEC/EN/HD 60364; HD 384; BS 7671; IEC/TR 60755; CEI 64.8; AS/NZ 3760; AS/NZ 3018
Electromagnetic compatibility: IEC/EN 61326-1; IEC/EN 61326-2-2
Safety: IEC/EN 61010-1; IEC/EN 61010-031

TECHNICAL DATA:

Function	Measuring range	Resolution	Accuracy
Insulation resistance (EN 61557-2)	U = 50, 100, 250 V _{DC} : R: 0.00 MΩ ... 19.99 MΩ 20.0 MΩ ... 99.9 MΩ 100.0 MΩ ... 199.9 MΩ	0.01 MΩ 0.1 MΩ 0.1 MΩ	±(5 % of reading + 3 digits) ±10 % of reading ±20 % of reading
	U = 500 V _{DC} , 1 kV _{DC} : R: 0.00 MΩ ... 19.99 MΩ 20.0 MΩ ... 199.9 MΩ 200 MΩ ... 999 MΩ	0.01 MΩ 0.1 MΩ 1 MΩ	±(5 % of reading + 3 digits) ±5 % of reading ±10 % of reading
Continuity 200 mA of PE conductor with polarity change (EN 61557-4)	0.00 Ω ... 19.99 Ω 20.0 Ω ... 199.9 Ω 200 Ω ... 1999 Ω	0.01 Ω 0.1 Ω 1 Ω	±(3 % of reading + 3 digits) ±5 % of reading ±5 % of reading
Loop impedance (EN 61557-3)	0.00 Ω ... 9.99 Ω 10.0 Ω ... 99.9 Ω 100 Ω ... 999 Ω 1.00 kΩ ... 9.99 kΩ	0.01 Ω 0.1 Ω 1 Ω 10 Ω	±(5 % of reading + 5 digits) ±(5 % of reading + 5 digits) ±10 % of reading ±10 % of reading
	0.00 Ω ... 9.99 Ω 10.0 Ω ... 99.9 Ω 100 Ω ... 999 Ω 1.00 kΩ ... 9.99 kΩ	0.01 Ω 0.1 Ω 1 Ω 10 Ω	±(5 % of reading + 5 digits) ±(5 % of reading + 5 digits) ±10 % of reading ±10 % of reading
Voltage drop	0.0 % ... 99.9 %	0.1 %	Consider accuracy of line impedance
Voltage	0 V ... 550 V	1 V	±(2 % of reading + 2 digits)
Frequency	0.00 Hz ... 9.99 Hz 10.0 Hz ... 499.9 Hz	0.01 Hz 0.1 Hz	±(0.2 % of reading + 1 digits)
Phase sequence (EN 61557-7)	1.2.3 or 3.2.1		
RCD testing (EN 61557-6)	I _{ΔN} : 10 mA, 30 mA, 100 mA, 300 mA, 500 mA, 1 A		
- Contact voltage U _c	0.0 V ... 19.9 V 20.0 V ... 99.9 V	0.1 V 0.1 V	(-0 % / +15 %) of reading ±10 digits (-0 % / +15 %) of reading
- Trip-out time	0 ms ... 40.0 ms 0 ms ... max. time	0.1 ms 0.1 ms	±1 ms ±3 ms
- Trip-out current	0.2 x I _{ΔN} ... 1.1 x I _{ΔN} (AC type) 0.2 x I _{ΔN} ... 2.2 x I _{ΔN} (A type, I _{ΔN} < 30 mA) 0.2 x I _{ΔN} ... 1.5 x I _{ΔN} (A type, I _{ΔN} ≥ 30 mA)	0.05 x I _{ΔN} 0.05 x I _{ΔN} 0.05 x I _{ΔN}	±0.1 x I _{ΔN} ±0.1 x I _{ΔN} ±0.1 x I _{ΔN}
Earth resistance (EN 61557-5)	0.00 Ω ... 19.99 Ω 20.0 Ω ... 199.9 Ω 200 Ω ... 9999 Ω	0.01 Ω 0.1 Ω 1 Ω	±(5 % of reading + 5 digits) ±(5 % of reading + 5 digits) ±(5 % of reading + 5 digits)
Power supply	6 x 1.2 V rechargeable batteries, type AA		
Overvoltage category	CAT III / 600 V; CAT IV / 300 V		
Protection class	Double insulation		
Dimensions	140 x 80 x 230 mm		
Weight	1.0 kg		

STANDARD SET:

- Instrument EurotestCOMBO
- Test lead, 3 x 1.5 m
- Schuko-plug test cable
- Power supply adapter + 6 NiMH rechargeable batteries, type AA
- Test probe, 3 pcs (blue, black, green)
- Crocodile clip, 3 pcs (blue, black, green)
- Set of carrying straps
- Short Instruction manual
- Instruction manual on CD
- Handbook on CD
- Calibration certificate



MI 2086 Eurotest 61557

The MI 2086 Eurotest 61557 performs complete testing of electrical installations and enables a number of additional features including TRMS current measurement, 4-wire / one clamp / two clamps earth resistance and 4-wire specific earth resistance measurements, illumination measurement and fuse / fault locator function. The handling of the instrument is simple and clear. Each test has its own individual help screen describing how to connect the instrument into the installation and how to perform a measurement. All the results can be saved on the instrument and then downloaded with the help of the EuroLink LITE software to the computer for evaluation and report generation after testing. The MI 2086 Eurotest 61557 performs continuity, insulation, RCD, loop, line, voltage, frequency, earth resistance and phase sequence testing required by the EN 61557 standard.

MEASURING FUNCTIONS:

- Insulation resistance with DC voltage;
- Continuity of PE conductors with 200 mA test current with polarity change;
- Continuity of PE conductors with 7 mA test current (continuous measurement) without RCD tripping;
- Line impedance;
- Loop impedance;
- Loop resistance with Trip Lock function;
- Voltage and frequency;
- Phase sequence;
- RCD testing (general and selective, type AC and A);
- Earth resistance (4-wire method, one clamp method, two clamps method);
- Specific earth resistance;
- TRMS leakage and load currents;
- Overvoltage protection devices testing;
- Illumination (option);
- Tracing the installations (option);
- High resolution loop impedance (mΩ).



KEY FEATURES:

- **Fuse location:** function enables the locating of fuses / wires / faults with the help of the optional A 1005 Fuse locator.
- **Earth resistance measurement:** instrument performs 4-wire earth resistance measurement with two additional rods; 4-wire earth resistance measurement in combination with an additional current clamp; earth resistance measurement with 2 current clamps without breaking the loop and 4-wire specific earth resistance measurement.
- **Downloadable:** downloads via RS232 cable directly to the PC with the help of the software included in the standard set.

- **Help screens:** instrument comes complete with built-in help screens for referencing on site.
- **Polarity swap:** automatic polarity reversal on continuity test.
- **Insulation range:** wide range of insulation test voltages from 50 V to 1000 V, reading up to 1000 MΩ.
- **Trip Lock function:** RLOOP function performs a loop resistance test without tripping the RCD.
- **RCD auto:** automated RCD testing procedure significantly reduces test time.
- **PC SW EuroLink LITE** included in the standard set enables downloading of test results and parameters and creation of test reports.

APPLICATION:

- Initial and periodic testing of domestic and industrial installations;
- Testing of single and multiphase systems;
- Testing of TT and TN systems.

STANDARDS:

Functionality: IEC/EN 61557
Other reference standards for testing: IEC/EN/HD 60364; IEC/EN 61008; IEC/EN 61009; IEC/EN/TR 60755; AS/NZ 3018; CEI 64.8; HD 384; BS 7671; VDE 0413
Electromagnetic compatibility: EN 50081 - 1; EN 50082 - 1
Safety: IEC/EN 61010-1; IEC/EN 61010-031; IEC/EN 61010-2-032

TECHNICAL DATA:

Function	Measuring range	Resolution	Accuracy	
Insulation resistance (EN 61557-2)	U = 50, 100 V _{DC} : R: 0.000 MΩ ... 1.999 MΩ 2.00 MΩ ... 19.99 MΩ 20.0 MΩ ... 199.9 MΩ	0.001 MΩ 0.01 MΩ 0.1 MΩ	±(5 % of reading + 3 digits) ±(5 % of reading + 3 digits) ±(5 % of reading + 3 digits)	
	U = 250, 500, 1000 V _{DC} : R: 0.000 MΩ ... 1.999 MΩ 2.00 MΩ ... 19.99 MΩ 20.0 MΩ ... 199.9 MΩ 200 MΩ ... 1000 MΩ	0.001 MΩ 0.01 MΩ 0.1 MΩ 1 MΩ	±(2 % of reading + 2 digits) ±(2 % of reading + 2 digits) ±(2 % of reading + 2 digits) ±10 % of reading	
Continuity of PE conductor with polarity change, test current 200 mA (EN 61557-4)	0.00 Ω ... 19.99 Ω 20.0 Ω ... 199.9 Ω 200 Ω ... 1999 Ω	0.01 Ω 0.1 Ω 1 Ω	±(2 % of reading + 2 digits) ±3 % of reading ±3 % of reading	
Low resistance continuity measurement, test current 7mA (continuous measurement)	0.0 Ω ... 199.9 Ω 200 Ω ... 2000 Ω	0.1 Ω 1 Ω	±(3 % of reading + 3 digits) ±(3 % of reading + 3 digits)	
Loop impedance (EN 61557-3)	0.00 Ω ... 19.99 Ω 20.0 Ω ... 199.9 Ω 200 Ω ... 2000 Ω	0.01 Ω 0.1 Ω 1 Ω	±(2 % of reading + 3 digits)	
	Line impedance (EN 61557-3)	0.00 Ω ... 19.99 Ω 20.0 Ω ... 199.9 Ω 200 Ω ... 2000 Ω		0.01 Ω 0.1 Ω 1 Ω
Voltage	0 V ... 440 V	1 V	±(2 % of reading + 2 digits)	
Phase sequence (EN 61557-7)	1.2.3 or 2.1.3.			
RCD testing (EN 61557-6)	I _{ΔN} : 10 mA, 30 mA, 100 mA, 300 mA, 500 mA, 1 A			
- Contact voltage U _c	0.0 V ... 9.99 V 10.0 V ... 100.0 V	0.01 V 0.1 V	(-0 / +10 %) of reading ± 0.2 V (-0 / +10 %) of reading	
- Trip-out time	0 ms ... 500 ms	1 ms	±3 ms	
- Trip-out current	0.2 x I _{ΔN} ... 1.1 x I _{ΔN} (AC type) 0.2 x I _{ΔN} ... 1.5 x I _{ΔN} (A type)	0.05 x I _{ΔN} 0.05 x I _{ΔN}	±0.1 x I _{ΔN} ±0.1 x I _{ΔN}	
Earth resistance (EN 61557-5) (4-wire method; 4-wire method with one clamp)	0.00 Ω ... 19.99 Ω 20.0 Ω ... 199.9 Ω 200 Ω ... 1999 Ω 2.00 kΩ ... 19.99 kΩ	0.01 Ω 0.1 Ω 1 Ω 10 Ω	±(2 % of reading + 3 digits) ±(2 % of reading + 3 digits) ±(2 % of reading + 3 digits) ± 5 % of reading	
	Earth resistance, two clamps method	0.00 Ω ... 19.99 Ω 20.0 Ω ... 100.0 Ω	0.01 Ω 0.1 Ω	±(10 % of reading + 2 digits) ± 20 % of reading
Current TRMS	0.0 mA ... 99.9 mA 100 mA ... 999 mA 1.00 A ... 9.99 A 10.0 A ... 99.9 A 100 A ... 200 A	0.1 mA 1 mA 0.01 A 0.1 A 1 A	±(5 % of reading + 3 digits) ± 5 % of reading ± 5 % of reading ± 5 % of reading ± 5 % of reading	
	Varistor Test	0 V ... 1000 V	1 V	± (5 % of reading +10 V)
	Illuminance (Type B)	0.00 lux ... 19.99 lux 20.0 lux ... 199.9 lux 200 lux ... 1999 lux 2.00 klux ... 19.99 klux	0.01 lux 0.1 lux 1 lux 10 lux	±(5 % of reading + 2 digits)
		Power supply	4 x 1.2 V rechargeable batteries or 4 x 1.5 V alkaline batteries, type C	
Over voltage category		CAT III / 300 V; CAT II / 600 V		
Protection class		Double insulation		
COM port	RS232			
Dimensions	265 x 110 x 185 mm			
Weight	2.1 kg			

STANDARD SET:

- MI 2086 ST**
- Instrument Eurotest 61557
 - Plug commander, 1.5 m
 - Test lead, 3 x 1.5 m
 - Crocodile clip
 - Test probe, 2 pcs (blue, black)
 - RS232 cable
 - PC Software EuroLink LITE
 - Set of carrying belts
 - Soft carrying bag
- MI 2086 EU**
- MI 2086 ST
 - Current clamp A 1018 (low range, leakage)
 - Test lead, 4 m
 - PC Software EuroLink PRO



MI 2086 EU

MI 2088 Earth - Insulation Tester

The MI 2088 Earth - Insulation Tester is a high professional, multifunctional, portable test instrument intended for carrying out earth resistance, insulation resistance and continuity of protection conductors measurements. The Earth - Insulation Tester enables 4-wire earth resistance measuring method, 4-wire earth resistance method in combination with one clamp, two clamps earth resistance measurement, 4-wire specific earth resistance measurement and TRMS current measurement. Besides the breakdown voltage of overvoltage protection devices can be checked by the instrument. All the results can be saved on the instrument and then downloaded with the help of the EarthLink software to the computer for evaluation and report generation after testing. The MI 2088 Earth - Insulation Tester performs earth resistance, continuity, insulation and voltage measurements required by the EN 61557 standard.

MEASURING FUNCTIONS:

- Insulation resistance with DC voltage;
- Continuity of PE conductors with 200 mA test current with polarity change;
- Continuity of PE conductors with 7 mA test current (continuous measurement) without RCD tripping;
- Voltage;
- Earth resistance (4-wire method, one clamp method, two clamps method).
- Specific earth resistance;
- TRMS leakage and load currents (option);
- Overvoltage protection devices testing.



KEY FEATURES:

- **Earth resistance measurement:** instrument performs 4-wire earth resistance measurement with two additional rods; 4-wire earth resistance measurement in combination with an additional current clamp; earth resistance measurement with 2 current clamps without breaking the loop and 4-wire specific earth resistance measurement.
- **Downloadable:** downloads via RS232 cable directly to the PC with the help of the software included in the standard set.
- **Polarity swap:** automatic polarity reversal on continuity test.

- **Insulation range:** wide range of insulation test voltages from 50 V to 1000 V, resistance measuring range up to 30 GΩ.
- **PC SW EarthLink** included in the standard set enables downloading of test results and parameters and creation of test reports.

APPLICATION:

- Initial and periodic testing of domestic and industrial installations;
- Testing of single and multiphase systems;
- Testing of TT and TN systems.

STANDARDS:

- Functionality:**
IEC/EN 61557
- Other reference standards for testing:**
IEC/EN/HD 60364;
AS/NZ 3018;
CEI 64.8;
HD 384;
BS 7671;
VDE 0413
- Electromagnetic compatibility:**
EN 50081-1; EN 50082-1
- Safety:**
IEC/EN 61010-1; IEC/EN 61010-031;
IEC/EN 61010-2-032

TECHNICAL DATA:

Function	Measuring range	Resolution	Accuracy
Insulation resistance (EN 61557-2)	U ≥ 250 V _{DC} : R: 0.000 MΩ ... 1.999 MΩ 2.00 MΩ ... 19.99 MΩ 20.0 MΩ ... 199.9 MΩ 200 MΩ ... 1999 MΩ 2.00 GΩ ... 19.99 GΩ 20.0 GΩ ... 29.9 GΩ	0.001 MΩ 0.01 MΩ 0.1 MΩ 1 MΩ 10 MΩ 100 MΩ	±(2 % of reading + 2 digits) ±(2 % of reading + 2 digits) ±(2 % of reading + 2 digits) ±(1 % of r. / 1 GΩ + 2% of r. + 2 digits) ±(1 % of r. / 1 GΩ + 2% of r. + 2 digits) ±(1 % of r. / 1 GΩ + 2% of r. + 2 digits)
	U < 250 V _{DC} : R: 0.000 MΩ ... 1.999 MΩ 2.00 MΩ ... 19.99 MΩ 20.0 MΩ ... 199.9 MΩ	0.001 MΩ 0.01 MΩ 0.1 MΩ	±(5 % of reading + 3 digits) ±(5 % of reading + 3 digits) ±(5 % of reading + 3 digits)
Continuity 200 mA of PE conductor with polarity change (EN 61557-4)	0.00 Ω ... 19.99 Ω 20.0 Ω ... 199.9 Ω 200 Ω ... 1999 Ω	0.01 Ω 0.1 Ω 1 Ω	±(2 % of reading + 2 digits) ±3 % of reading ±3 % of reading
Low resistance continuity measurement, test current 7 mA (continuous measurement)	0.0 Ω ... 199.9 Ω 200 Ω ... 1999 Ω	0.1 Ω 1 Ω	±(3 % of reading + 3 digits) ±(3 % of reading + 3 digits)
Earth resistance 4-wire method	0.00 Ω ... 19.99 Ω 20.0 Ω ... 199.9 Ω 200 Ω ... 1999 Ω 2.00 kΩ ... 19.99 kΩ	0.01 Ω 0.1 Ω 1 Ω 10 Ω	±(2 % of reading + 3 digits) ±(2 % of reading + 3 digits) ±(2 % of reading + 3 digits) ±5 % of reading
	0.00 Ω ... 19.99 Ω 20.0 Ω ... 199.9 Ω 200 Ω ... 999 Ω 1.00 kΩ ... 1.99 kΩ	0.01 Ω 0.1 Ω 1 Ω 10 Ω	±(2 % of reading + 3 digits) ±(2 % of reading + 3 digits) ±(2 % of reading + 3 digits) ±(2 % of reading + 3 digits)
2-clamp earth resistance measurement	0.00 Ω ... 19.99 Ω 20.0 Ω ... 100.0 Ω	0.01 Ω 0.1 Ω	±(10 % of reading + 2 digits) ±20 % of reading
Specific earth resistance (EN 61557-5)	0.00 Ω ... 19.99 Ω 20.0 Ω ... 199.9 Ω 200 Ω ... 1999 Ω 2.00 kΩ ... 19.99 kΩ 20.0 kΩ ... 199.9 kΩ 200 kΩ ... 999 kΩ (a < 8 m) 200 kΩ ... 1999 kΩ (a ≥ 8 m)	0.01 Ω 0.1 Ω 1 Ω 10 Ω 0.1 kΩ 1 kΩ 1 kΩ	±(2 % of reading + 3 digits) ±(2 % of reading + 3 digits) ±(2 % of reading + 3 digits) ±5 % of reading ±5 % of reading ±5 % of reading ±5 % of reading
	0.00 Ω ... 19.99 Ω 20.0 Ω ... 199.9 Ω 200 Ω ... 1999 Ω	0.01 Ω 0.1 Ω 1 Ω	±(2 % of reading + 3 digits) ±(2 % of reading + 3 digits) ±(2 % of reading + 3 digits)
	0.00 kΩ ... 19.99 kΩ 20.0 kΩ ... 199.9 kΩ 200 kΩ ... 999 kΩ (a < 8 m) 200 kΩ ... 1999 kΩ (a ≥ 8 m)	0.1 kΩ 1 kΩ 1 kΩ	±5 % of reading ±5 % of reading ±5 % of reading
	0.0 mA ... 99.9 mA 100 mA ... 999 mA 1.00 A ... 9.99 A 10.0 A ... 99.9 A 100 A ... 200 A	0.1 mA 1 mA 0.01 A 0.1 A 1 A	±(5 % of reading + 3 digits) ±5 % of reading ±5 % of reading ±5 % of reading ±5 % of reading
TRMS Current	0.0 mA ... 99.9 mA 100 mA ... 999 mA 1.00 A ... 9.99 A 10.0 A ... 99.9 A 100 A ... 200 A	0.1 mA 1 mA 0.01 A 0.1 A 1 A	±(5 % of reading + 3 digits) ±5 % of reading ±5 % of reading ±5 % of reading ±5 % of reading
Varistor Test	0 V ... 1000 V	1 V	±(5 % of reading + 10 V)
Power supply	4 x 1.2 V rechargeable batteries or 4 x 1.5 V alkaline batteries, type C		
Over voltage category	CAT III / 300 V; CAT II / 600 V		
Protection class	Double insulation		
COM port	RS232		
Dimensions	265 x 110 x 185 mm		
Weight	1.7 kg		

STANDARD SET:

- MI 2088 ST**
- Instrument Earth-Insulation Tester
 - Test lead, 2 x 1,5 m
 - Soft carrying bag
 - RS232 cable
 - Test probe, 2 pcs (red, black)
 - Crocodile clip
 - PC Software EarthLink
 - Instruction manual
 - Handbook on CD
 - Calibration certificate



- MI 2088 - 20 m**
- MI 2088 ST
 - Earth test set, 20 m (test lead, 4 x 1 m; 2 x test lead, 20 m; 2 x test lead, 4.5 m; 4 x earth test rod; small soft carrying bag)





- MI 2088 - 50 m**
- MI 2088 ST
 - Earth test set, 50 m (test lead, 4 x 1 m; 2 x test lead, 50 m; 2 x test lead, 1 m; 2 x test lead, 4.5 m; 4 x earth test rod; soft carrying bag)



MI 2088 - 50 m

Selection Guide for Single-functional Testers

Part No.		MI 3121 Insulation / Continuity	MI 3122 Z Line-Loop / RCD
Features	Description		
INSULATION	Insulation resistance	✓	-
	Test voltage (V _{DC})	50 ... 1000	-
	Insulation resistance measuring range	up to 30 GΩ	-
CONTINUITY AND LOW RESISTANCE MEASUREMENT	Continuity of PE conductor with automatic polarity change, test current 200mA	✓	-
	Low resistance measurement (continuous measurement), test current 7 mA.	✓	-
LINE / LOOP IMPEDANCE	Line impedance with Ipsc calculation	-	✓
	Loop impedance with Ipsc calculation	-	✓
	RCD Trip Lock loop impedance	-	✓
	Built-in fuse tables for PASS / FAIL evaluation	-	✓
RCD TESTING	Contact voltage without RCD tripping	-	✓
	RCD trip-out time	-	✓
	RCD trip-out current with rising test current	-	✓
	Automatic testing of RCDs	-	✓
	RCD type (general and selective)	-	A, AC
VOLTAGE, FREQUENCY	AC voltage measurement	✓	-
	Online voltage monitor	-	✓
	Frequency measurement	✓	✓
PHASE SEQUENCE	L1 - L2 - L3	-	✓
EARTH, CURRENT MEASUREMENTS	Earth resistance 3-(4-)wire method	-	-
	Earth resistance 3-(4-)wire method with additional current clamp	-	-
	Earth resistance measurement with 2 current clamps	-	-
	Soil resistance measurement	-	-
	TRMS current	-	-
IT EARTHING SYSTEM SPECIFIC MEASUREMENTS	Insulation Monitoring Devices (IMD) testing (IT systems)	-	-
	First fault leakage current (ISFL) measurement (IT systems)	-	-
	Predifined mini Autosequences	-	-
OTHER FEATURES	PASS / FAIL evaluation of test results	✓	✓
	Touch electrode	-	✓
	Help menu	-	✓
COMMUNICATION PORTS	RS232	✓	✓
	USB	✓	✓
MEMORY, SOFTWARE	Memory	✓	✓
	Number of memory levels / memory locations	2 / 1500	3 / 1500
	Professional PC SW	Option	Option
	Advanced PC SW	Option	Option
GENERAL DATA	Safety category	CAT III / 600 V CAT IV / 300 V	CAT III / 600 V CAT IV / 300 V
	Batteries	6 x AA	6 x AA
	Built-in battery charger	✓	✓
	Weight	850 g	930 g
	Dimentions (mm)	140 x 80 x 230	140 x 80 x 230

MI 3123 Earth / Clamp	MI 3110 EurotestIM	MI 2126 Earth 2-3	MI 3103 GigaOhm 1 kV
			
-	-	-	✓
-	-	-	250 ... 1000
-	-	-	up to 2 GΩ
-	✓	-	✓
-	✓	-	✓
-	✓	-	-
-	-	-	-
-	-	-	-
-	✓	-	-
-	-	-	-
-	-	-	-
-	-	-	-
-	✓	-	✓
-	✓	-	-
-	✓	-	-
-	✓	-	-
✓	-	-	-
Option	-	-	-
Option	-	-	-
✓	-	-	-
Option	-	-	-
-	✓	-	-
-	✓	-	-
-	✓	-	-
✓	✓	-	-
✓	✓	-	-
✓	✓	-	-
3 / 1500	3 / 500	-	-
Option	✓	-	-
Option	-	-	-
CAT IV / 50 V	CAT III / 600 V CAT IV / 300 V	-	CAT III / 300 V
6 x AA	6 x AA	4 x C	4 x C
✓	✓	-	-
850 g	1.31	410 g	490 g
140 x 80 x 230	230 x 103 x 115	280 x 70 x 80	280 x 70 x 80

MI 3121 SMARTeC[®] Insulation / Continuity

The MI 3121 SMARTeC Insulation / Continuity is a new generation tester for dead testing of electrical installations. With both an analogue and digital representation of the results, the instrument ensures accurate measurements up to 2000 Ω on continuity and up to 30 GΩ on insulation function. Configurable limits enable a PASS / FAIL evaluation of test results, which is accompanied with the bright red and green indicator lights for comfortable use even in the dark conditions. The MI 3121 is equipped with a built-in charger and has a magnetic holder in order to free up hands for testing. All the results can be quickly saved on the instrument and then downloaded via the optional A 1291 EuroLink PRO or A 1290 EuroLink PRO Plus software for evaluation and professional report generation after testing. The MI 3121 SMARTeC Insulation / Continuity performs continuity, insulation AC voltage and frequency measurement tests.

MEASURING FUNCTIONS:

- Insulation resistance with DC voltage;
- Continuity of PE conductors with 200 mA test current with polarity change;
- Continuity of PE conductors with 7 mA test current (continuous measurement) without RCD tripping;
- TRMS voltage and frequency.

KEY FEATURES:

- **Insulation range:** wide range of insulation test voltages from 50 V to 1000 V, measuring range up to 30 GΩ.
- **Analogue scale and digital LCD:** measuring results are displayed both in numeric and analogue representation.
- **Downloadable:** downloads via RS232 or USB cable directly to the PC with the help of the optional software.
- **Upgradeable:** if changes occur to the regulations upgrades can be made to the firmware to keep the instrument up to date.
- **Polarity swap:** automatic polarity reversal on continuity test.
- **Built-in charger & rechargeable batteries:** instrument has a built-in charging circuit and comes complete with a set of rechargeable NiMH batteries.
- **Custom limits:** if limits are set on insulation or continuity function then large green and red lights of the LEDs will indicate a PASS or FAIL evaluation of test result.
- **Easy to use:** large bright LCD display and large buttons enable easy handling of the instrument (even while wearing gloves).
- **Magnetic holder:** magnet for fixing instrument on metal surfaces enables hands-free operation.



APPLICATION:

- Domestic dead circuit testing;
- Industrial dead circuit testing;
- Telecommunication systems testing;
- Resistance measurements.

STANDARDS:

Functionality:
IEC/EN 61557

Other reference standards for testing:

IEC/EN/HD 60364;
AS/NZ 3018;
CEI 64.8;
HD 384;
BS 7671;
VDE 0413

Electromagnetic compatibility:

IEC/EN 61326-1;
IEC/EN 61326-2-2

Safety:

IEC/EN 61010-1;
IEC/EN 61010-031

TECHNICAL DATA:

Function	Measuring range	Resolution	Accuracy
Insulation resistance (EN 61557-2)	U = 500, 1000 V _{DC} : R: 0.00 MΩ ... 19.99 MΩ 20.0 MΩ ... 199.9 MΩ 200 MΩ ... 999 MΩ 1.00 GΩ ... 4.99 GΩ 5.00 GΩ ... 19.99 GΩ 20.0 GΩ ... 29.9 GΩ	0.01 MΩ 0.1 MΩ 1 MΩ 10 MΩ 10 MΩ 100 MΩ	±(5 % of reading + 3 digits) ±5 % of reading ±5 % of reading ±10 % of reading ±20 % of reading Indicator only
	U = 50, 100, 250 V _{DC} : R: 0.00 MΩ ... 19.99 MΩ 20.0 MΩ ... 99.9 MΩ 100.0 MΩ ... 199.9 MΩ	0.01 MΩ 0.1 MΩ 0.1 MΩ	±(5 % of reading + 3 digits) ±10 % of reading ±20 % of reading
Continuity 200 mA of PE conductor with polarity change (EN 61557-4)	0.00 Ω ... 19.99 Ω 20.0 Ω ... 199.9 Ω 200 Ω ... 1999 Ω	0.01 Ω 0.1 Ω 1 Ω	±(3 % of reading + 3 digits) ±5 % of reading ±10 % of reading
Low resistance measurement with 7 mA test current (continuous measurement)	0.0 Ω ... 19.9 Ω 20 Ω ... 1999 Ω	0.1 Ω 1 Ω	±(5 % of reading + 3 digits) ±10 % of reading
Voltage	0.0 V ... 99.9 V 100 V ... 550 V	0.1 V 1 V	±(3 % of reading + 3 digits)
Frequency	0.00 Hz ... 19.99 Hz 20.0 Hz ... 199.9 Hz 200 Hz ... 500 Hz	0.01 Hz 0.1 Hz 1 Hz	±(0.2 % of reading + 1 digits)
Power supply	6 x 1.2 V rechargeable batteries, type AA		
Overvoltage category	CAT III / 600 V; CAT IV / 300 V		
Protection class	Double insulation		
COM port	RS232 and USB		
Dimensions	140 x 230 x 80 mm		
Weight	0.85 kg		

KEY FEATURES



Large LCD screen with backlight and PASS / FAIL indicators.



Simple and fast manipulation.



USB and RS232 communication ports.

STANDARD SET:

- Instrument Smartec Insulation / Continuity
- Soft hand strap
- Test lead, 2 x 1.5 m
- Test probe, 2 pcs (black, red)
- Crocodile clip, 2 pcs (black, red)
- Power supply adapter + 6 NiMH rechargeable batteries, type AA
- Instruction manual on CD
- Short instruction manual
- Handbook on CD
- Calibration certificate



MI 3122 SMARTEC® Z Line-Loop / RCD

The MI 3122 SMARTEC Z Line-Loop / RCD is designed specifically for live circuit testing. The instrument contains integrated characteristics of fuses and RCDs for the evaluation of test results. The online voltage monitoring system allows the operator to control what is happening on three simultaneous voltages in real-time. The bright red and green PASS / FAIL lights and help screens for each measurement make the handling of the instrument easy and clear. All the results can be quickly saved on the instrument and then downloaded via the optional A 1291 EuroLink PRO or A 1290 EuroLink PRO Plus software for evaluation and professional report generation after testing. The MI 3122 SMARTEC Z Line-Loop / RCD performs RCD, loop, line, AC voltage, frequency and phase sequence tests required by the EN 61557 standard.

MEASURING FUNCTIONS:

- Line impedance;
- Loop impedance;
- Loop impedance with Trip Lock RCD function;
- TRMS voltage and frequency;
- Phase sequence;
- RCD testing (general and selective, type AC and A).

KEY FEATURES:

- **Help screens:** instrument comes complete with built-in help screens for referencing on site.
- **LED Pass/Fail indicators:** two LED indicators for PASS / FAIL evaluation of test results are placed on both sides of the LCD.
- **Built-in fuse tables:** this unique feature allows automatic evaluation of the line / loop impedance compared to the regulations.
- **Online voltage monitoring:** monitors all 3 voltages in real-time.
- **Downloadable:** downloads via RS232 or USB cable directly to the PC with the help of the optional software.
- **Upgradeable:** if changes occur to the regulations upgrades can be made to the firmware to keep the instrument up to date.
- **Trip Lock function:** Zs (RCD) function performs a loop impedance test without tripping the RCD.
- **Built-in charger & rechargeable batteries:** instrument has a built-in charging circuit and comes complete with a set of rechargeable NiMH batteries.
- **RCD auto:** automated RCD testing procedure significantly reduces test time.
- **Easy to use:** large bright LCD display

and large buttons enable easy handling of the instrument (even while wearing gloves).

- **Magnetic holder:** magnet for fixing instrument on metal surfaces enables hands-free operation.

APPLICATION:

- Domestic and Industrial live circuit testing;
- Testing of single phase and 3-phase, TT and TN systems.



STANDARDS:

Functionality:
IEC/EN 61557

Other reference standards for testing:
IEC/EN/HD 60364; IEC/EN 61008;
IEC/EN 61009; IEC/EN/TR 60755; AS/
NZ 3760; AS/NZ 3018; CEI 64.8; HD
384; BS 7671; VDE 0413

Electromagnetic compatibility:

IEC/EN 61326-1;
IEC/EN 61326-2-2

Safety:

IEC/EN 61010-1; IEC/EN 61010-031

TECHNICAL DATA:

Function	Measuring range	Resolution	Accuracy
RCD testing (EN 61557-6)	I _{ΔN} : 10 mA, 30 mA, 100 mA, 300 mA, 500 mA, 1 A		
- Scaling factor for I _{ΔN}	x 0.5; x 1; x 2; x 5		
- Contact voltage U _c	0.0 V ... 19.9 V 20.0 V ... 99.9 V	0.1 V 0.1 V	(-0%/+15%) of reading ± 10 digits (-0%/+15%) of reading
- Trip-out current	(0.2 ... 1.1) x I _{ΔN} (AC type) (0.2 ... 1.5) x I _{ΔN} (A type, I _{ΔN} ≥ 30 mA) (0.2 ... 2.2) x I _{ΔN} (A type, I _{ΔN} < 30 mA)	0.05 x I _{ΔN} 0.05 x I _{ΔN} 0.05 x I _{ΔN}	± 0.1 x I _{ΔN} ± 0.1 x I _{ΔN} ± 0.1 x I _{ΔN}
- Trip-out time	0.0 ms ... 40.0 ms 0.0 ms ... max. time	0.1 ms 0.1 ms	± 1 ms ± 3 ms
Loop impedance (EN 61557-3)	0.00 Ω ... 9.99 Ω 10.0 Ω ... 99.9 Ω 100 Ω ... 999 Ω 1.00 kΩ ... 9.99 kΩ	0.01 Ω 0.1 Ω 1 Ω 10 Ω	±(5 % of reading + 5 digits) ±(5 % of reading + 5 digits) ±10 % of reading ±10 % of reading
Line impedance (EN 61557-3)	0.00 Ω ... 9.99 Ω 10.0 Ω ... 99.9 Ω 100 Ω ... 999 Ω 1.00 kΩ ... 9.99 kΩ	0.01 Ω 0.1 Ω 1 Ω 10 Ω	±(5 % of reading + 5 digits) ±(5 % of reading + 5 digits) ±10 % of reading ±10 % of reading
Voltage	0 V ... 550 V	1 V	±(2 % of reading + 2 digits)
Frequency	15.0 Hz ... 499.9 Hz	0.1 Hz	±(0.2 % of reading + 1 digit)
Phase sequence (EN 61557-7)	1.2.3 or 3.2.1		
Power supply	6 x 1.2 V rechargeable batteries, type AA		
Overvoltage category	CAT III / 600 V; CAT IV / 300 V		
Protection class	Double insulation		
COM port	RS232 and USB		
Dimensions	140 x 230 x 80 mm		
Weight	0.93 kg		

KEY FEATURES



Large LCD screen with backlight and PASS / FAIL indicators.



Simple and fast manipulation.



USB and RS232 communication ports.

STANDARD SET:

- Instrument Smartec Z Line - Loop / RCD
- Soft hand strap
- Schuko-plug test cable
- Test lead, 3 x 1.5 m
- Test probe, 3 pcs (blue, black, green)
- Crocodile clip, 3 pcs (blue, black, green)
- Power supply adapter + 6 NiMH rechargeable batteries, type AA
- Instruction manual on CD
- Short instruction manual
- Handbook on CD
- Calibration certificate



MI 3123 SMARTeC[®] Earth / Clamp

The MI 3123 SMARTeC Earth / Clamp is a new generation earth resistance tester with the ability to perform 4-wire earth resistance measurement and 4-wire specific earth resistance measurement. With the optional A 1018 and A 1019 current clamps the instrument can perform 4-wire earth resistance measurement with one current clamp, contactless earth resistance testing with two clamps and TRMS current measurement up to 20 A. Configurable limits enable a PASS / FAIL evaluation of test results. All the results can be saved on the instrument and then downloaded via the optional software for evaluation and professional report generation after testing. The lightweight design, large bright LCD screen, built-in help screens, optional downloading via RS232 or USB ports and overvoltage category CAT IV make the MI 3123 an incredible earth resistance measuring instrument.

MEASURING FUNCTIONS:

- Earth resistance, 4-wire method;
- Earth resistance, 4-wire method with one current clamp (option);
- Earth resistance, two clamps method (option);
- Specific earth resistance;
- TRMS current (option).

KEY FEATURES:

- **Earth resistance measurement:** instrument performs standard 4-wire earth resistance tests with two earthing rods and specific earth resistance measurement.
- **Selective earth resistance test:** optional 4-wire earth resistance measurement in combination with an additional current clamp is used for measuring earth resistance of individual earthing rods.
- **Contactless earth resistance test:** earth resistance measurement with 2 current clamps without breaking the loop is intended for measuring resistance of individual earthing rods and is recommended first of all for urban areas.
- **Downloadable:** downloads via RS232 or USB cable directly to the PC with the help of the optional software.
- **Upgradeable:** if changes occur to the regulations upgrades can be made to the firmware to keep the instrument up to date.
- **Help screens:** instrument comes complete with built-in help screens for referencing on site.
- **Built-in charger & rechargeable batteries:** instrument has a built-in charging



ing circuit and comes complete with a set of rechargeable NiMH batteries.

- **Custom limits:** the limits can be set on any function, in that case large green and red lights of the LEDs will indicate a PASS or FAIL evaluation of test result.
- **Easy to use:** large bright LCD display and large buttons enable easy handling of the instrument (even while wearing gloves).
- **Magnetic holder:** magnet for fixing instrument on metal surfaces enables hands-free operation.

APPLICATION:

- Testing on TT and IT systems;
- Testing sub-station earthing;
- Lightning system testing.

STANDARDS:

Functionality: IEC/EN 61557
Other reference standards for testing: IEC/EN/HD 60364; AS/NZ 3018; CEI 64.8; HD 384; BS 7671; VDE 0413
Electromagnetic compatibility: IEC/EN 61326-1; IEC/EN 61326-2-2
Safety: IEC/EN 61010-1; IEC/EN 61010-031; IEC/EN 61010-2-032

TECHNICAL DATA:

Function	Measuring range	Resolution	Accuracy
Earth resistance (4-wire method (EN 61557-5); 4-wire method with one current clamp)	0.00 Ω ... 19.99 Ω	0.01 Ω	±(3 % of reading + 3 digits)
	20.0 Ω ... 199.9 Ω	0.1 Ω	±(3 % of reading + 3 digits)
	200 Ω ... 1999 Ω	1 Ω	±5 % of reading
Earth resistance (2 clamps method)	0.00 Ω ... 19.99 Ω	0.01 Ω	±(10 % of reading + 10 digits)
	20.0 Ω ... 30.0 Ω	0.1 Ω	±20 % of reading
	30.1 Ω ... 99.9 Ω	0.1 Ω	±30 % of reading
Specific earth resistance (EN 61557-5)	0.0 Ωm ... 99.9 Ωm	0.1 Ωm	Calculated value, consider earth resistance 4-wire method
	100 Ωm ... 999 Ωm	1 Ωm	
	1.00 kΩm ... 9.99 kΩm	0.01 kΩm	
	10.0 kΩm ... 99.9 kΩm	0.1 kΩm	
	>100 kΩm	1 kΩm	
TRMS Current	0.0 mA ... 99.9 mA	0.1 mA	±(3 % of reading + 3 digits)
	100 mA ... 999 mA	1 mA	
	1.00 A ... 19.99 A	0.01 A	
Power supply	6 x 1.2 V rechargeable batteries, type AA		
Overvoltage category	CAT IV / 50 V		
Protection class	Double insulation		
COM port	RS232 and USB		
Dimensions	140 x 230 x 80 mm		
Weight	0.85 kg		

KEY FEATURES



Large LCD screen with backlight and PASS / FAIL indicators.



Simple and fast manipulation.



USB and RS232 communication ports.

STANDARD SET:

- Instrument Smartec Earth / Clamp
- Soft hand strap
- Test lead, 4.5 m (blue)
- Test lead, 4.5 m (red)
- Test lead, 20 m (green)
- Test lead, 20 m (black)
- Earth test rod, 4 pcs
- Power supply adapter + 6 NiMH rechargeable batteries, type AA
- Instruction manual on CD
- Short instruction manual
- Handbook on CD
- Calibration certificate



MI 3110 EurotestIM

The MI 3110 EurotestIM is a perfect tool for testing of permanent integrated or portable Low Voltage Electrical Installations supplied by Generator or Transformer and protected by an IT earthing system. Designed for simple but efficient safety testing of Integrated IT Earthing System powered with LV Generator or Transformer! With a single, pre-programmed **AUTO SEQUENCE**® with sub-tests and adjustable limits it is possible to perform all the necessary verifications of safety limits of a specific LV IT installation.

MEASURING FUNCTIONS:

- Voltage, frequency and phase sequence.
- Line impedance and prospective short circuit current.
- Voltage drop.
- First fault leakage current (ISFL).
- Testing of insulation monitoring devices (IMD).

KEY FEATURES:

- **AUTO SEQUENCE**®: One single **AUTO SEQUENCE**® with programmable limits and sub-tests ensuring Safety on all PASS bar-rier parameters.
- **Voltage monitor**: IT System recognizing, Voltage Range and Voltage Balance.
- **ISFL test**: ISFL Single Fault Leakage current from Phase 1 and Phase 2 to PE. Fuse Trip-out Ability Evaluation, Line Impedance and Ipsc Prospective Short Circuit Current.
- **IMD control**: IMD Insulation / ELM Earth Leakage / RCM Residual Current Monitor Devices Control.
- **IMD adjust**: Alarm Trigger or Trip-Out Check and Adjust.

APPLICATION:

- Safety and functionality on IT installations in industry, in hospitals;
- Connection of portable power generators;
- Fire fighting mobile equipment, generators and pumps;
- Military vehicles and generators;
- Police vehicles and generators;
- Construction sites and Road maintenance;
- SAT and radio / TV broadcasting mobile equipment;
- Safety and functionality on IT installations on the airports, concert halls, fair



locations with generators;

- Marines and ships;
- Mines, other special locations;
- Adjustment and calibrations of IMD devices.

STANDARDS:

Functionality:

IEC/EN 61557

Other reference standards for testing:

EN 60364-4-41;
BS 7671;
AS/NZS 3017

Electromagnetic compatibility:

IEC/EN 61326-1;
IEC/EN 61326-2-2

Safety:

IEC/EN 61010 -1;
EN 61010-2-030;
EN 61010-031

STANDARD SET:

- Instrument MI 3110 EurotestIM
- Soft carrying bag
- Mains measuring cable
- Test lead, 3 x 1.5 m
- Test probe, 3 pcs
- Crocodile clip, 3 pcs
- Set of carrying straps
- RS232-PS/2 cable
- USB cable
- Set of NiMH battery cells
- Power supply adapter
- PC software EuroLink PRO
- Short instruction manual
- Instruction manual on CD
- Handbook on CD
- Calibration Certificate



TECHNICAL DATA:

Function	Measuring range	Resolution	Accuracy
Voltage	0 V ... 550 V	1 V	±(2 % of reading + 2 digits)
Frequency	0.00 Hz ... 9.99 Hz 10.0 Hz ... 499.9 Hz	0.01 Hz 0.1 Hz	±(0.2 % of reading + 1 digit)
Phase sequence (EN 61557-7)	1.2.3 or 3.2.1		
Line impedance (EN 61557-3)	0.00 Ω ... 9.99 Ω 10.0 Ω ... 99.9 Ω	0.01 Ω 0.1 Ω	±(5 % of reading + 5 digits)
Prospective short-circuit current	0.00 A ... 0.99 A 1.0 A ... 99.9 A 100 A ... 999 A 1.00 kA ... 99.99 kA 100 kA ... 199 kA	0.01 A 0.1 A 1 A 10 A 1000 A	Consider accuracy of line resistance measurement
First fault leakage current (ISFL)	0.0 mA ... 19.9 mA	0.1 mA	±(5 % of reading + 3 digits)
Threshold indicative insulation resistance	5 kΩ ... 640 Ω	5 kΩ	Indicative values Up to 128 steps
Power supply	6 x 1.2 V rechargeable batteries, type AA		
Overvoltage category	CAT III / 600 V; CAT IV / 300 V		
Protection class	Double insulation		
Dimensions	230 x 103 x 115 mm		
Weight	1.1 kg		

KEY FEATURES



Construction and Maintenance / Medical / Fire / Military / Industry / Audio and Video / Racing / Ships And Marina Places

MI 2126 Earth 2/3

The MI 2126 Earth 2/3 is a high quality, professional grade test instrument for performing three-wire earth resistance measurements in accordance with European standard EN 61557-5, on which the estimation of earthing quality is based. The equipment was designed and produced according to many years of experience of producing and dealing with earth resistance and electric installation test equipment.

MEASURING FUNCTIONS:

- Earth resistance, 3-wire method.

KEY FEATURES:

- **Earth resistance measurement:** instrument performs standard 3-wire earth resistance tests with two earthing rods.
- **Easy to use:** only 3 buttons control all the operations of the test instrument and instruction manual explains various earth resistance measuring methods.
- **Portable:** the MI 2126 is light and battery operated instrument and can be easily placed with other test instruments for moving between tested items.
- **Reliable:** reliable results even in the presence of stray currents.
- **Repeatability:** outstanding repeatability of test results especially in the case of high test probe resistance of various earthing structures (e.g. asphalt, sand, and stone).

APPLICATION:

- 3-wire earth resistance testing;
- Testing single rod and multiple spiked earthing networks.

STANDARDS:

Functionality: IEC/EN 61557-1; IEC/EN 61557-5

Other reference standards for testing: IEC/EN/HD 60364; AS/NZ 3018; CEI 64.8; HD 384; BS 7671; VDE 0413
Electromagnetic compatibility: IEC/EN 61326
Safety: IEC/EN 61010-1; IEC/EN 61010-031

STANDARD SET:

- Instrument Earth 2/3
- Carrying strap
- Test lead, 4.5 m (black)
- Test lead, 15 m (red)
- Test lead, 20 m (blue)
- Earth test rod, 2 pcs
- Instruction manual
- Calibration certificate



Function	Measuring range	Resolution	Accuracy
Earth resistance	0.00 Ω ... 19.99 Ω	0.01 Ω	± (2% of reading + 10 digits)
	20.0 Ω ... 199.9 Ω	0.1 Ω	± (2% of reading + 10 digits)
	200 Ω ... 999 Ω	1 Ω	± (2% of reading + 10 digits)
	1.000 kΩ ... 1.999 kΩ	1 Ω	± (2% of reading + 10 digits)
	2.00 kΩ ... 19.99 kΩ	10 Ω	±5% of reading
Power supply	4 x 1.5 V alkaline batteries, type C		
Protection class	Double insulation		
Dimensions	280 x 70 x 80 mm		
Weight	410 g		

MI 3103 GigaOhm 1 kV

The MI 3103 GigaOhm 1 kV tester is an easy to use installation tester with the ability to perform accurate resistance measurements quickly and efficiently. Features including AC voltage testing, robust design, easy to read display and rotary switch (which can be used even while wearing gloves) make the MI 3103 Gigaohm 1 kV an extremely good value and versatile instrument to use.

MEASURING FUNCTIONS:

- Insulation resistance with DC voltage;
- Continuity of PE conductors with 200 mA test current with polarity change;
- Continuity of PE conductors with 7 mA test current (continuous measurement) without RCD tripping;
- Voltage.

KEY FEATURES:

- **Easy to use:** 3 buttons and rotary function selector control all the operations of the test instrument.
- **Insulation range:** three different test voltages (250, 500 and 1000 V), wide measuring range up to 2 GΩ.
- **Polarity swap:** automatic polarity reversal on continuity test.
- **Compensation of test leads** (up to 5 Ω) eliminates lead resistance.

APPLICATION:

- Domestic installation dead testing.
- Periodic installation testing.

STANDARDS:

Functionality: IEC/EN 61557-1, IEC/EN 61557-2, IEC/EN 61557-4, IEC/EN 61557-10,
Other reference standards for testing:

IEC/EN/HD 60364; AS/NZ 3018; CEI 64.8; HD 384; BS 7671; VDE 0413
Electromagnetic compatibility: IEC/EN 61326
Safety: IEC/EN 61010-1; IEC/EN 61010-031

TECHNICAL DATA:

Function	Measuring range	Resolution	Accuracy
Insulation resistance (EN 61557-2)	U = 500, 1000 V _{DC} : R: 0.000 MΩ ... 1.999 MΩ 2.00 MΩ ... 19.99 MΩ 20.0 MΩ ... 199.9 MΩ > 200 MΩ	0.001 MΩ 0.01 MΩ 0.1 MΩ 1 MΩ	± (3% of reading + 3 digits) ± (3% of reading + 3 digits) ± (3% of reading + 3 digits) ± 10% of reading
	U = 250 V _{DC} : R: 0.000 MΩ ... 1.999 MΩ 2.00 MΩ ... 19.99 MΩ 20.0 MΩ ... 199.9 MΩ 200 MΩ ... 1999 MΩ	0.001 MΩ 0.01 MΩ 0.1 MΩ 1 MΩ	± (5% of reading + 3 digits) ± (5% of reading + 3 digits) ± (5% of reading + 3 digits) ± 15% of reading
Continuity 200 mA of PE conductor with polarity change (EN 61557-4)	0.11 Ω ... 19.99 Ω 20.0 Ω ... 199.9 Ω 200 Ω ... 1999 Ω	0.01 Ω 0.1 Ω 1 Ω	±(3% of reading + 3 digits) ±(3 % of reading + 3 digits) ±5% of reading
Low resistance measurement 7 mA (continuous measurement)	0.0 Ω ... 199.9 Ω 200 Ω ... 999 Ω 1000 Ω ... 1999 Ω	0.1 Ω 1 Ω 1 Ω	±(5% of reading + 3 digits) ±10% of reading ±10% of reading
Voltage	0 V ... 600 V	1 V	±(3% of reading + 3 digits)
Power supply	4 x 1.5 V alkaline batteries, type C		
Overvoltage category	CAT III / 300 V		
Dimensions	280 x 70 x 80 mm	Weight	490 g

STANDARD SET:

- Instrument GigaOhm 1 kV
- Carrying strap
- Test lead with test probe, 2 m, (black)
- Test lead with test probe, 2 m, (red)
- Crocodile clip (black)
- Instruction manual
- Calibration certificate



A 1143 Euro Z 290 A

The A 1143 Euro Z 290 A is a professional portable high current impedance tester. It performs high precision line and high precision fault loop impedance measurements in environments up to CAT IV / 310 V.

MEASURING FUNCTIONS:

- High precision line impedance;
- High precision fault loop impedance;
- Contact voltage.

KEY FEATURES:

- **Independence:** instrument is designed to work independantly or in conjunction with: MI 2086 Eurotest 61557, MI 3101 EurotestAT, MI 3105 EurotestXA and MI 3321 MultiServicerXA.
- **Range widening:** adapts the instruments to read from 0.1 mΩ up to 19.99 Ω.
- **Multi-system testing:** works on both single phase and 3-phase systems (115 V to 440 V).
- **IpSC and IpFC calculation:** IpSC and IpFC readings calculated up to 400 kA.
- **4-wire measurement** for elimination of voltage drop on measuring leads.
- **Comfortable carrying:** all the accessories are put in the strong, rugged, durable case of the instrument.
- **LCD:** Built-in LCD for standalone measurements.

APPLICATION:

- High accuracy loop and line measurements;
- Power transformer and motor winding measurement.

STANDARDS:

Functionality: IEC/EN 61557
Other reference standards for testing:

IEC/EN/HD 60364; AS/NZ 3018;
 CEI 64.8; BS 7671; VDE 0413
Electromagnetic compatibility:
 IEC/EN 61326-1; IEC/EN 61326-2-2
Safety: IEC/EN 61010-1;
 IEC/EN 61010-031

TECHNICAL DATA:

Function	Measuring range	Resolution	Accuracy
High resolution Line / Loop impedance measurement	0.1 mΩ ... 199.9 mΩ	0.1 mΩ	±(5% of reading + 1 mΩ)
	200 mΩ ... 1999 mΩ	1 mΩ	±(5% of reading + 1 mΩ)
	2.00 Ω ... 19.99 Ω	10 mΩ	±(5% of reading + 10 mΩ)
Measuring voltage range	90 V ... 530 V		
Maximum test current (at 230 V)	154 A (10 ms)		
Maximum test current (at 400 V)	267 A (10 ms)		
Maximum test current (at 530 V)	350 A (10 ms)		
Contact voltage	0 V ... 100 V	1 V	±(10% of reading + 3 digits)
Power supply	4 x 1.5 V alkaline batteries, type C		
Overvoltage category	310 V / CAT IV		
Protection class	Double insulation		
Pollution degree	2		
Dimensions	345 x 160 x 335 mm		
Weight	5.0 kg		



STANDARD SET:

- Instrument Euro Z 290 A
- Test lead, 2-wire, 2 pcs
- Test lead, black, 2 m
- Test probe, red, 2 pcs
- Crocodile clip, black, 3 pcs
- Crocodile clip, red, 2 pcs
- RS232 cable
- RS232-PS/2 cable
- Instruction manual
- Calibration certificate



MI 2093 Line Tracer

The MI 2093 Line Tracer is an universal instrument intended for tracing hidden conductive paths under plasters in walls, floors and ground or for determining one wire in a tuft of wires. Fuses or outlets belonging to a certain loop can be located as well. Line Tracer helps the operator to resolve hidden line problems easily (short circuits, interruptions, breakages).

FUNCTIONS:

- Tracing cables in walls, ceilings, floor and ground;
- Tracing live or voltage free cables;
- Locating cable interruptions and short-circuits in cables;
- Locating concealed sockets and distribution boxes;
- Locating fuses and assignment to circuits;
- Determining an individual wire in a bundle of wires;
- Tracing pipe installations and other conductive loops.

KEY FEATURES:

- Detection depth up to 2 m can be achieved.
- Works on both, energized and non-energized systems.
- The highly sensitive Receiver R10K detects injected signal around the measured line or object.
- Three levels of sensitivity adjustment: low, middle and high. Each level can be additionally precisely adjusted.
- Dual, bar-graph and buzzer indicator ensures indication in dark and noisy environment.

APPLICATION:

- Electrical installations testing;
- Cable networks testing;
- Pipe installations testing;
- Telecommunication systems testing.

TECHNICAL DATA:

Transmitter T10K	
Power supply	4 x 1.5 V alkaline or 4 x 1.2 V rechargeable batteries, type AA
Overvoltage category	CAT III / 300 V
Dimensions	80 x 50 x 150 mm
Weight	280 g
Receiver R10K	
Power supply	1 x 9 V battery
Dimensions	45 x 450 x 210 mm
Weight	140 g



STANDARDS:

Electromagnetic compatibility:
 IEC/EN 61326
Safety:
 IEC/EN 61010-1; IEC/EN 61010-031

STANDARD SET:

- Transmitter T10K
- Receiver R10K
- Test lead for R10K with built-in resistor and test probe, 1.5 m
- Test lead for T10K, 1.5 m, 2 pcs
- Special selective probe
- Test probe, black, 2 pcs
- Crocodile clip, black, 2 pcs
- Soft carrying bag
- Instruction manual
- Calibration certificate



A 1199 ρ -Adapter

The ρ -Adapter is a special accessory intended for using only with METREL installation testers MI 3101 Eurotest AT and MI 3105 EurotestXA. It is designed for measurement of specific earth resistance.

KEY FEATURES:

- Adapter is used for performing 4-wire specific earth resistance measurements;
- Designed for use in conjunction with the MI 3101 Eurotest AT and MI 3105 EurotestXA;
- The instrument comes complete with 4-wire test lead, 15 m red extension lead, 2 earthing rods and carrying bag;
- Instruction manual contains step by step guide on how to perform the measurement;
- It is recommended to use A 1199 in combination with 3-wire 20 m earth test lead set (S 2026).

APPLICATION:

- 4-wire earth resistance measurement;
- Specific earth resistance measurement.

STANDARDS:

Functionality: IEC/EN 61557
Other reference standards for testing: IEC/EN/HD 60364; AS/NZ 3018; CEI 64.8; BS 7671; VDE 0413
Electromagnetic compatibility: IEC/EN 61326
Safety: IEC/EN 61010-1



TECHNICAL DATA:

Power supply	4 x 1.5 V alkaline or 4 x 1.2 V rechargeable batteries, type AA
Overvoltage category	CAT IV / 50 V
Dimensions	100 x 200 x 50 mm
Weight	390 g

STANDARD SET:

- ρ -adapter
- Small soft carrying bag
- Earth test rod, 2 pcs
- Test lead, red, 15 m
- Test lead 4 x 1,5 m
- Instruction manual
- Calibration certificate



CS 2099 Eurocheck

The CS 2099 Eurocheck is a professional, multifunctional field calibrator intended for use with installation test instruments. Accuracy and functionality of all Metrel and most other manufacturer's installation testers can be verified with the Eurocheck. The CS 2099 Eurocheck can provide a simple field calibration of the most frequently used functions when testing installations.

FUNCTIONS:

- Insulation calibration with test voltage up to 1000 V;
- Calibration of low resistance and continuity functions;
- Fault loop and trip-lock RCD impedance functions calibration (all test currents supported on Metrel instruments);
- Calibration of RCD trip-out time function;
- Calibration of line impedance measuring function;
- Calibration of voltage and frequency;
- PE test terminal functional verification;
- Automatic polarity verification

APPLICATION:

- On-site testing of installation measuring instruments;
- Occasional routine control of the safety testers.

STANDARDS:

Electromagnetic compatibility: IEC/EN 61326
Safety: IEC/EN 61010-1



TECHNICAL DATA:

Power supply	230 V, 50 / 60 Hz
Overvoltage category	CAT II / 300 V
Dimensions	103 x 61 x 205 mm
Weight	780 g

STANDARD SET:

- Instrument Eurocheck
- Small soft carrying bag
- Instruction manual



MI 3088 PV Demonstration Board

Demonstration board MI 3088 simulates typical photovoltaic (PV) system with one PV module and DC/AC inverter. It represents a typical installation that consist of PV string, DC switch box, DC/AC inverter and one phase connection to the power grid. It is intended for use preferably by sales personnel for demonstration of the measuring methods and procedures on DC and partially on AC side of a PV system.

KEY FEATURES:

- With this demo board all electrical tests according to EN 625446 can be demonstrated: continuity, isolation, open circuit voltage U_{oc} , short circuit current I_{sc} and polarity.
- It simulates an I/V characteristic of a PV module/string.
- Simulated output of the irradiance and temperature sensor.
- Simulation of a DC/AC inverter with one DC input and single phase output.

APPLICATION:

- Presentation of testing of a PV system;
- Demonstration of PV test equipment by sales personnel.

STANDARDS:

Functionality: EN 62446

Electromagnetic compatibility: EN 61326

Safety: EN 61010-1

TECHNICAL DATA:

Power supply	115 V/ 230 V, 50 Hz / 60 Hz
Overvoltage category	CAT II / 300 V
Dimensions	450 x 330 x 110 mm
Weight	12.5 kg



STANDARD SET:

- Demonstration board
- Mains cable
- PS2 male / male adapter
- Test lead 1.5 m, black
- Test lead 1.5 m, red
- User manual



MA 2067 Demonstration Board

Demonstration Board MA 2067 is an excellent demonstration and educational tool that simulates real conditions in low voltage electrical installations. The Demonstration board consists of all significant elements of electrical installations like RCDs of different types, fuses, PE equalization bars, 1-phase and 3-phase sockets, various consumers of electrical energy and various grounding systems (TT, TN, IT). The MA 2067 Demonstration Board provides simulation of different types of faults in electroinstallation. Complete testing and troubleshooting of the installation is possible by using suitable instruments.

KEY FEATURES:

- 65 different measurements in accordance to EN 61557 are possible (insulation resistance, continuity of PE conductors, earth resistance, specific earth resistance, line and loop impedance, phase rotation, leakage current, RCD testing, voltage and frequency).
- 19 different errors can be selected on a lockable distributor.
- Different types of RCD are integrated for measurement of trip-out time, trip-out current and contact voltage
- Simulation of TT, TN and IT earth systems.
- Possibility of connection to single phase or 3-phase supply system.
- Booklet with theory and exercises for schools and training centers is included in a standard set.

APPLICATION:

- Education of students of electrotechnical specialities;
- Education and practical training of electrical contractors about measurements on low voltage electroinstallations;
- Demonstration on how to use different measurement instruments by sales personnel.

STANDARDS:

Electromagnetic compatibility: IEC/EN 61326

Safety: IEC/EN 61010-1

TECHNICAL DATA:

Power supply	230 V / 400 V, 50 Hz
Dimensions	680 x 450 mm (w x h)
Weight	12.5 kg

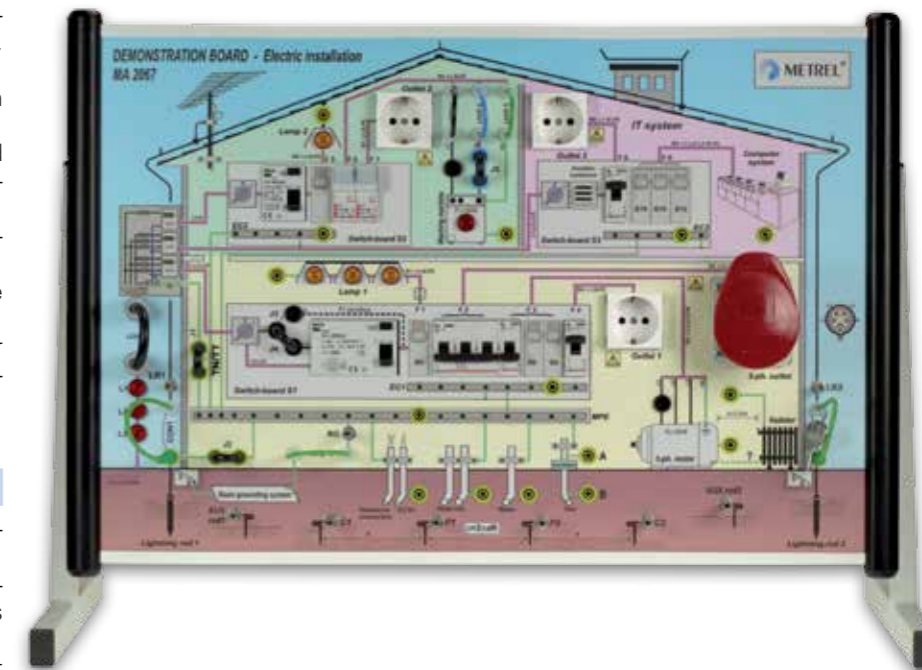

STANDARD SET:

- Demonstration board
- Jumper, 4 pcs
- Board support for vertical use
- Three phase to one phase adapter
- 1-phase mains cable
- Instruction manual
- Booklet with exercises
- Calibration certificate



MI 3099 Demonstration Board

Demonstration board MI 3099 simulates typical electrical installation usually met in individual houses or apartments with important elements on switchboard and on circuit site. Demonstration board is intended for use preferably by sales personnel when demonstrating operation of electrical installation test equipment, especially the new Metrel's electrically installations safety testers with built-in AUTOSEQUENCE procedure.

KEY FEATURES:

- The board contains real elements of electrical installation like RCD, mains switch, automatic fuses, switches, lamps, 1-phase and 3-phase mains test outlet, N and PE collector.
- All standardised testing methods can be presented.
- TN or TT system with or without RCD can be simulated.
- Possibility of connection to single phase or 3-phase supply system.
- Various Autosequence test procedures are supported for demonstration of testing safety by new EurotestAT and EurotestXA.
- Demonstration board is put in the strong rugged case with a handle for comfortable carrying.

APPLICATION:

- Presentation of complete testing of any electrical installation;
- Demonstration of electrical installation test equipment operation by sales personnel.

STANDARDS:

Electromagnetic compatibility:

IEC/EN 61326

Safety:

IEC/EN 61010-1

TECHNICAL DATA:

Power supply	230 V / 400 V, 50 Hz
Overvoltage category	CAT II / 300 V
Dimensions	480 × 387 × 136 mm
Weight	5 kg

STANDARD SET:

- Demonstration board
- Jumper
- Special probe, 3 pcs
- Mains cable
- Three phase to one phase adapter
- Instruction manual
- Calibration certificate



MI 2166 Demonstration Board

Demonstration board MI 2166 simulates common electrical installation usually met in individual house or apartment. Demonstration board is to be used preferably by sales personnel when demonstrating operation of electrical installation test equipment. Various test methods supported by different test instruments can be presented.

KEY FEATURES:

- A number of different measurements in accordance to EN 61557 are possible (insulation resistance, continuity of PE conductors, earth resistance (four-lead and two clamp methods), specific earth resistance, line and loop impedance, phase rotation, load current, RCD testing, contact voltage, etc.).
- Real elements of electrical installation are placed on the front panel like RCD, ON/OFF switch with lamp, mains test outlet and connection terminals.
- All standardised testing methods can be presented.
- 5 different errors can be preset by »fault« switches.
- TN or TT system can be simulated.
- Demonstration board is put in the strong rugged case with a handle for comfortable carrying.

APPLICATION:

- Presentation of complete testing of any electrical installation;
- Demonstration of electrical installation test equipment operation by sales personnel.

STANDARDS:

Electromagnetic compatibility:

IEC/EN 61326

Safety:

IEC/EN 61010-1

STANDARD SET:

- Demonstration board
- Jumper, 2 pcs
- Mains cable
- Instruction manual
- Calibration certificate



EuroLink PRO and EuroLink PRO Plus

The EuroLink PRO / PRO Plus software works in conjunction with Metrel's downloadable installation testers. The software automatically finds the instrument and allows the test engineer to download test results saved on the instrument, review the results, relocate test results (if required), print test reports and print installation structures for storing in the distribution board. With the more advanced Metrel installation testers, structures can be built with the software and uploaded to the instrument for easy installation navigation while performing on-site testing. Additionally the EuroLink PRO Plus software offers the ability to automatically generate professional PRO Plus Reports.

KEY FEATURES:

- **Automatic recognition of the instrument:** when connecting your instrument to the PC it is automatically recognized by the software.
- **Simple graphical visualisation of the installation structure:** enables graphical representation of the tested installation which makes it easy to navigate in the installation.
- **10-level structures:** in conjunction with MI 3105 and MI 3101 PC software enables creating the electrical installation structures with up to 10 levels and 4 levels for other models.
- **Rearranging of structures:** the elements of the structure can be relocated and renamed.
- **Installation structures printing:** structures can be printed and stored in the distribution board for easier later identification of the installation elements.
- **Structures upload:** the installation structure can be created in advance on the PC and then simply uploaded to your tester MI 3108, MI 3109, MI 3105, MI 3101, MI 3102H CL, MI 3102H BT, MI 3102 BT, MI 3100 SE, MI 3125 BT and MI 3125B.
- **Export of test results:** test results in text format can be exported to other programs (MS Excel, MS Word).
- **Automatic PRO Test Report generation:** enables automatic generation of PRO Test Report (low, medium and high detailed).
- **Automatic PRO Plus Test Report generation (PRO Plus version only):** enables automatic generation of PRO Plus Test Report which include visual inspection of tested object and test results in tabular form.
- **Support of EuroLink Android:** supports extended file format from EuroLink Android App.

PC SW EuroLink PRO / PRO Plus is compatible with:

- MI 3108, MI 3109, MI 3105, MI 3101, MI 3102, MI 3102H CL, MI 3102H BT,

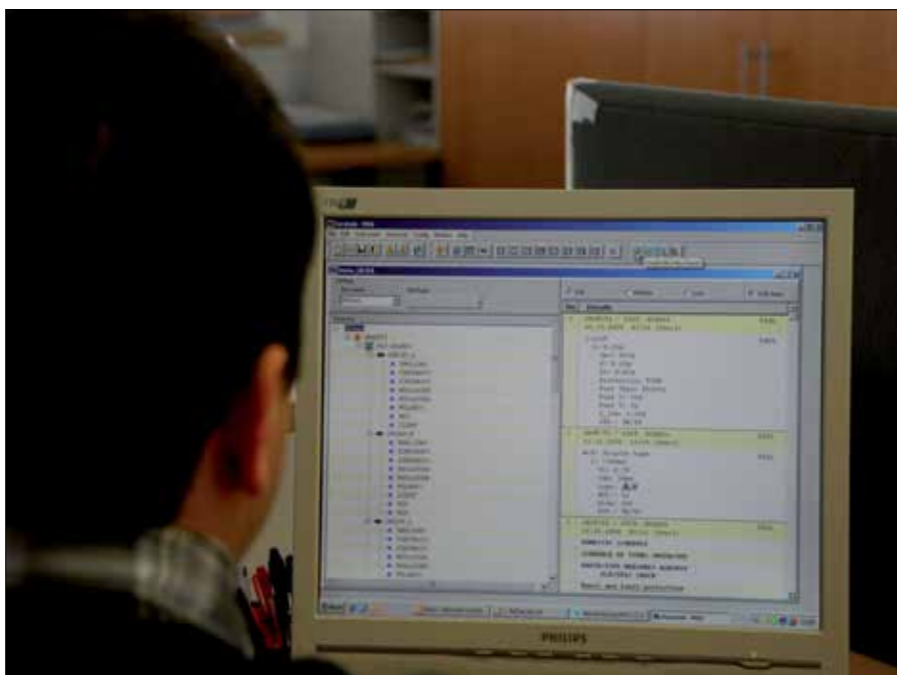

MI 3102 BT, MI 3100 SE, MI 3002, MI 3125 BT, MI 3125B, MI 3121, MI 3121H, MI 3122 and MI 3123.

Key features of PRO Plus Test Reports:

- Downloaded test results are automatically inserted onto PRO Plus forms.
- Allows to fill out visual inspection form for tested fuse cabinet or earthing system.
- Automatically selects worst case test results for form completion.
- Easy test report generation and reviewing facilities.

EuroLink PRO Plus enables creation of the following test reports:

- PRO Plus Test Report
- NICEIC certificates (UK)
- ZVEH certificates (Germany)
- SiNa certificates (Switzerland)
- ÖVE certificates (Austria)
- HD 384 certificates (Greek)
- KEHE certificates (Greek)

- GOST R 50571 (Russia)
- UNE – 202008 certificates (Spain)

PASSWORD PROTECTION:

PC SW EuroLink PRO is password protected for the following instruments:

- MI 3121,
- MI 3121H,
- MI 3122,
- MI 3123.

PC SW EuroLink PRO Plus is password protected for all Metrel installation testers.

ORDERING INFORMATION:

- **A 1291** PC SW EuroLink PRO with USB and RS232-PS/2 cable
- **A 1290** PC SW EuroLink PRO Plus with USB and RS232-PS/2 cable
- **A 1292** Upgrade code EuroLink PRO to EuroLink PRO Plus

Tree view installation structure can be easily rearranged by customer.

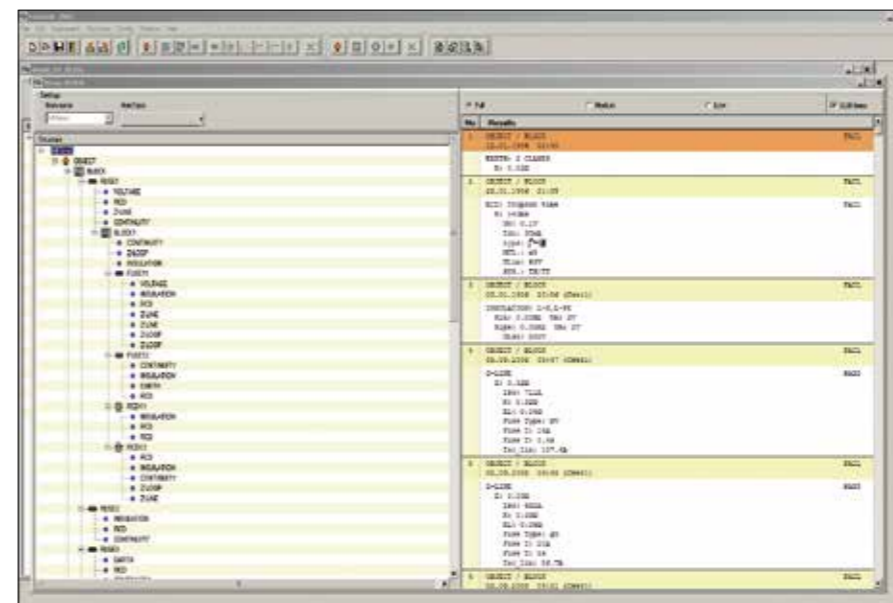

PRO Test Report.

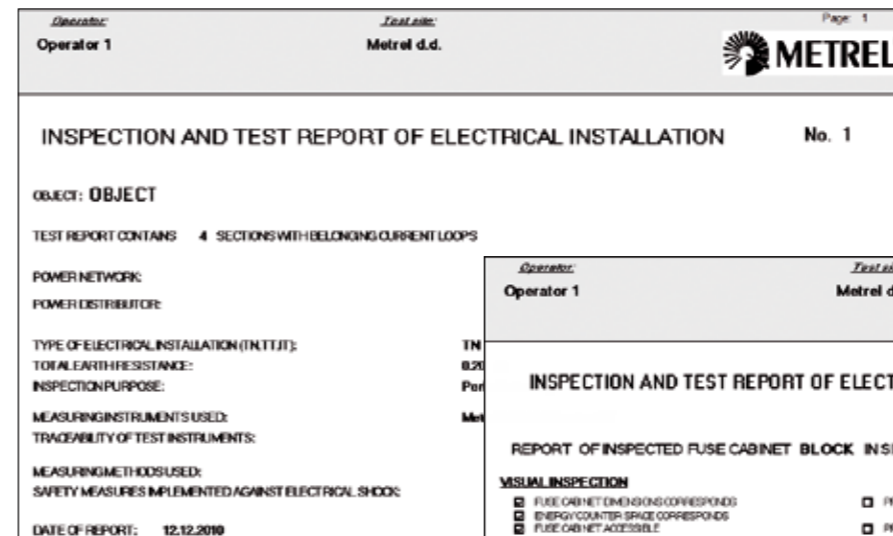
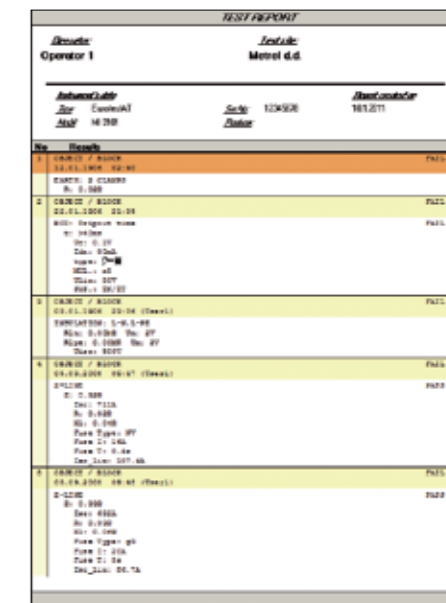

PRO Plus Test Report.

Name of Current Loop	Wire Section	Measured Value of Insulation Resistance (kΩm)	Measured Value of Insulation Resistance (kΩm)	Position Resistance of Earthing Subsystems (Ωm)	PE Conductivity (250 mA)	Continuity of Additional Protective Earthing	Overcurrent Protection Characteristic (Trip out Time)	LINE Impedance ZLN / Ωc	LOOP Impedance ZLN / Ωc	RCD Type	RCD IT	RCD IΔn	RCD IΔn	RCD IΔn	RCD IΔn	RCD IΔn	RCD IΔn
1 FUSES	16/2	1000	1000	1000	0.3	1000	1000	1000	1000	General	30	30	30	30	30	30	30
2 FUSES	16/2	1000	1000	1000	0.3	1000	1000	1000	1000	General	30	30	30	30	30	30	30
3 FUSES	16/2	1000	1000	1000	0.3	1000	1000	1000	1000	General	30	30	30	30	30	30	30
4 FUSES	16/2	1000	1000	1000	0.3	1000	1000	1000	1000	General	30	30	30	30	30	30	30
5 FUSES	16/2	1000	1000	1000	0.3	1000	1000	1000	1000	General	30	30	30	30	30	30	30

A 1431 EuroLink Android

The EuroLink Android is a data management tool for android tablets and smart phones. It is used in the field together with Metrel's Electrical Installation Safety testers to serve as a measurement pre- and post-processing tool. It also enables the wireless communication between instrument and Android device on one side and bunch of wireless communication methods between Android device and PC.

KEY FEATURES:

- Create the Reports already at the site of Testing!
- Attach notes, Photographs, Audio or Video Files!
- Share the Reports or Send them to your clients!
- Create Structure of Electrical Installation at the site.
- Upload Structure of Electrical Installation to your test instrument
- Download measurement results to EuroLink Android Application.
- Transfer Data, Share files or Send them through your Tablet or Smart Phone Tools to your Office for further manipulation.
- It is compatible with EuroLink PRO and EuroLinkPRO Plus PC software.
- It supports Bluetooth dongle or built-in BT enabling communication channel between the below listed measuring instruments and a smart phone or a tablet with Android OS and installed application EuroLink Android.



Create Structure of Electrical Installation at the site.

Transfer Data, Share files or Send them through your Tablet or Smart Phone Tools to your Office for further manipulation.

EuroLink Android is compatible with:

- MI 3105 EurotestXA (supported by BT dongle)
- MI 3101 EurotestAT (supported by BT dongle)
- MI 3102 BT EurotestXE
- MI 3102H BT EurotestXE
- MI 3100 SE EurotestEAS1 (supported by BT dongle)
- MI 3125BT EurotestCOMBO
- MI 3108 EurotestPV (supported by BT dongle)

Supported by BT dongle



Built-in BT solution



A 1428 EuroLinkPV Android

The EuroLinkPV Android is a data management tool for android tablets and smart phones. It is used at the site of testing together with Metrel's Photovoltaic testers as a measurement pre- and post-processing tool. It enables the wireless communication between instrument and Android device. With this application testing of PV is more comfortable and effective.

KEY FEATURES:

- View the results of the I/V measurement in graphical or numerical form.
- Compare the results with the nominal values and characteristic.
- Edit the module data stored in instrument memory using the Android Keyboard.
- Edit the module list stored in instrument memory.
- The module data can be selected from the huge module Data Base delivered within the EuroLinkPV Android application.
- It supports Bluetooth dongle enabling a communication channel between the below listed measuring instruments and a smart phone or a tablet with Android OS and installed application EuroLinkPV Android.

EuroLink Android is compatible with:

- MI 3108 EurotestPV (supported by BT dongle)
- MI 3109 EurotestPV Lite (supported by BT dongle)

Supported by BT dongle



Built-in BT solution

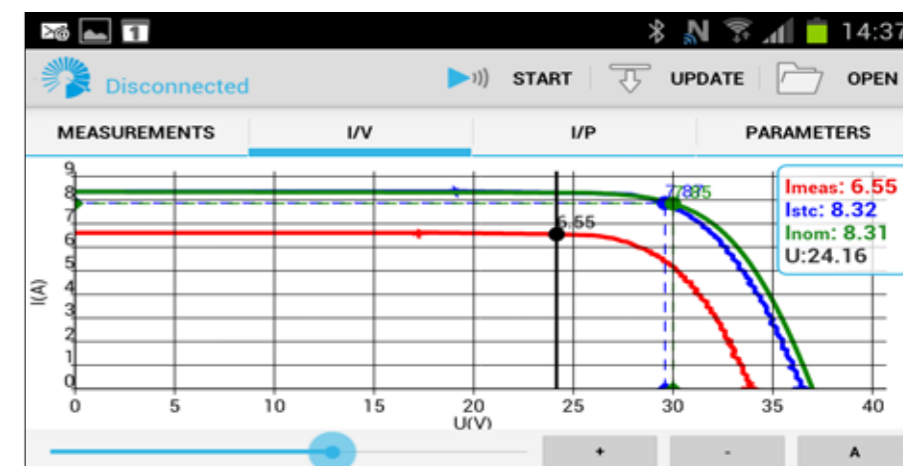
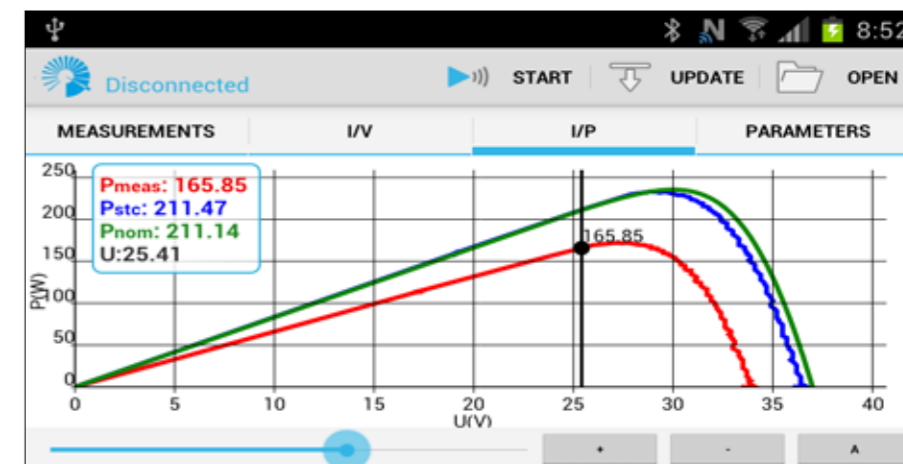

	MEAS	STC	NOM
Uoc	33.1 V	36.5 V	37.0 V
Isc	8.28 A	10.09 A	8.35 A
Umpp	23.7 V	26.4 V	30.0 V
Impp	7.56 A	9.22 A	7.85 A
Pmpp	179.0 W	243.0 W	235.0 W

1/20	DEF. MODULE
2/20	METREL GMBH
3/20	SW235
4/20	CONRAD20W
5/20	DEMO

Selection Guide for EIS Accessories

Photo	Part number	Description	Target application	MI 3108	MI 3109	MI 3105	MI 3101	MI 3102 BT	MI 3100 SE	MI 3100 S	MI 3125 BT	MI 3125	MI 2086	MI 2088	MI 3121	MI 3122	MI 3123	MI 3110	MI 2126	MI 3103	MI 2093	A 1143	
	A 1143	Euro Z 290 A	Euro Z 290 A is the impedance tester which enables line / loop impedance measurements with an accuracy down to 0.1 mΩ.	-	-	✓	-	-	-	-	-	✓	-	-	-	-	-	-	-	-	-	-	-
	A 1199	Ro-adapter	Ro-adapter is intended for performing earth resistance measurement in combination with installation safety tester.	-	-	✓	✓	✓	-	-	-	-	-	-	-	-	-	-	-	-	-	-	-
	A 1378	EurotestPV Remote	PV remote unit for measurement and logging of irradiance and temperature values	✓	✓	-	-	-	-	-	-	-	-	-	-	-	-	-	-	-	-	-	-
	A 1384	PV Safety Probe	The PV safety probe can safely disconnect the PV installation from the installation in case of a permanent short circuit.	✓	✓	-	-	-	-	-	-	-	-	-	-	-	-	-	-	-	-	-	-
	CS 2099	Eurocheck	Eurocheck is a professional multifunctional field calibrator intended for use with installation safety testers.	-	-	✓	✓	✓	✓	✓	✓	✓	✓	✓	✓	✓	✓	✓	✓	✓	✓	✓	-
	A 1160	Fast charger for 8 AA batteries with a set of 6 NiMH bat., type AA	Fast battery charger for up to 8 pieces of AA rechargeable batteries, and a set of 6 pcs NiMH rechargeable batteries, type AA.	✓	✓	✓	✓	✓	✓	✓	✓	✓	-	-	✓	✓	✓	✓	✓	✓	✓	✓	-
	A 1169	Fast charger for AA, C, D and 9 V block batteries	Fast battery charger for up to 12 pcs AA, 6 pcs C or D rechargeable batteries, 4 pcs 9 V block batteries.	✓	✓	✓	✓	✓	✓	✓	✓	✓	✓	✓	✓	✓	✓	✓	✓	✓	✓	✓	-
	A 1083	Power supply adapter with 6 pcs NiMH batteries, type AA	Battery charger and a set of 6 pieces of rechargeable batteries, type AA.	✓	✓	✓	✓	✓	✓	✓	✓	✓	-	-	✓	✓	✓	✓	✓	✓	✓	✓	-
	A 1399	PV Reference Cell	Irradiance sensor for PV measurements.	✓	✓	-	-	-	-	-	-	-	-	-	-	-	-	-	-	-	-	-	-
	A 1400	PV Temperature probe	Temperature probe for measurement of PV module temperature.	✓	✓	-	-	-	-	-	-	-	-	-	-	-	-	-	-	-	-	-	-
	A 1102	Luxmeter sensor, type B	Luxmeter sensor, type B, for high-accuracy illuminance measurement.	-	-	-	-	-	-	-	-	✓	-	-	-	-	-	-	-	-	-	-	-
	A 1119	Luxmeter sensor, type C	Luxmeter sensor, type C, for illuminance measurement e.g. for general light conditions testing.	-	-	-	-	-	-	-	-	✓	-	-	-	-	-	-	-	-	-	-	-

✓ Option - Not available

Selection Guide for EIS Accessories

Photo	Part number	Description	Target application	MI 3108	MI 3109	MI 3105	MI 3101	MI 3102 BT	MI 3100 SE	MI 3100 S	MI 3125 BT	MI 3125	MI 2086	MI 2088	MI 3121	MI 3122	MI 3123	MI 3110	MI 2126	MI 3103	MI 2093	A 1143	
	A 1172	Luxmeter sensor, type B (PS/2)	Luxmeter sensor, type B, for high-accuracy illuminance measurement e.g. for emergency lightning inspection.	-	-	✓	-	✓	-	-	-	-	-	-	-	-	-	-	-	-	-	-	-
	A 1173	Luxmeter sensor, type C (PS/2)	Illuminance probe for light conditions measurements with 0,1Lux resolution.	-	-	✓	-	✓	-	-	-	-	-	-	-	-	-	-	-	-	-	-	-
	A 1005	Fuse / fault / cable locator	Fuse / fault / cable locator is used for wire tracing, fuse identification and fault finding in low voltage electrical installations.	-	-	-	-	-	-	-	-	-	✓	-	-	-	-	-	-	-	-	-	-
	A 1191	Receiver R10K	Receiver R10K is used for wire tracing, fuse identification and fault finding in low voltage electrical installations.	-	-	✓	✓	-	-	-	-	-	-	-	-	-	-	-	-	-	-	-	-
	A 1192	Selective probe for R10K	Very sensitive inductive sensor serves for contactless fuse and cable finding. To be used with A 1191.	-	-	✓	✓	-	-	-	-	-	-	-	-	-	-	-	-	-	-	-	✓
	A 1067	Test lead for R10K, 1.5 m, with built-in resistor	Test lead with probe enables fast and accurate fuse finding and current circuit allocation. To be used with A 1191.	-	-	✓	✓	-	-	-	-	-	-	-	-	-	-	-	-	-	-	-	✓
	A 1168	Plug commander (for MI 3100)	Single phase schuko plug commander with TEST and BACKLIGHT function keys for fast and simple measurements on one phase sockets.	-	-	-	-	-	-	✓	-	✓	-	-	-	-	-	-	-	-	-	-	-
	A 1256	Plug commander (straight cable)	Single phase schuko plug commander with TEST and MEM function keys for fast and simple measurements on one phase sockets.	-	-	✓	✓	-	-	-	-	✓	-	-	✓	-	-	-	-	-	-	-	-
	A 1170	Plug commander	Single phase schuko plug commander with TEST and MEM function keys for fast and simple measurements on one phase sockets.	-	-	✓	✓	-	-	-	-	-	-	-	-	-	-	-	-	-	-	-	✓
	A 1272	Plug commander (for Smartec)	Single phase schuko plug commander with TEST and MEM function keys for fast and simple measurements on one phase sockets.	-	-	-	-	-	-	-	-	-	-	-	-	-	-	✓	-	✓	-	-	-
	A 1314	Plug commander	Single phase, 3-wire, commander with TEST and MEM function and RGB LED indicator for easy insulation safety measurements for use with MI 3108 and its successors.	✓	-	-	✓	✓	-	✓	✓	-	-	-	-	-	-	-	-	✓	-	-	-
	A 1401	Tip commander	Single phase, 3-wire, commander with TEST and MEM function and RGB LED indicator for easy insulation safety measurements for use with MI 3108 and its successors.	✓	-	-	✓	✓	-	✓	✓	-	-	-	-	-	-	-	-	✓	-	-	-

✓ Option - Not available

Selection Guide for EIS Accessories

Photo	Part number	Description	Target application	MI 3108	MI 3109	MI 3105	MI 3101	MI 3102 BT	MI 3102 BT	MI 3100 SE	MI 3100 S	MI 3125 BT	MI 3125	MI 2086	MI 2088	MI 3121	MI 3122	MI 3123	MI 3110	MI 2126	MI 3103	MI 2093	A 1143
	A 1002	Tip commander	Single phase 2-wire commander with test tip and START and SAVE function keys for installation safety measurements.	-	-	-	-	-	-	-	-	-	✓	-	-	-	-	-	-	-	-	-	-
	A 1175	Tip commander (for MI 3100)	Single phase 2-wire commander with test tip and TEST and BACKLIGHT function keys for installation safety measurements.	-	-	-	-	-	-	-	-	-	-	-	-	-	-	-	-	-	-	-	-
	A 1176	Tip commander	Single phase 2-wire commander with test tip and TEST and MEM function keys for installation safety measurements.	-	-	✓	-	-	-	-	-	-	-	-	-	-	-	-	-	-	-	-	-
	A 1194	Tip commander, 3-wire (for MI 3100)	Single phase 3-wire commander with test tip, TEST and BACKLIGHT function keys for installation safety measurements.	-	-	-	-	-	-	-	-	-	-	-	-	-	-	-	-	-	-	-	-
	A 1197	Tip commander, 3-wire	Single phase 3-wire commander with test tip, TEST and MEM function keys for installation safety measurements.	-	-	✓	-	-	-	-	-	-	-	-	-	-	-	-	-	-	-	-	-
	A 1244	Tip commander, 2-wire (straight cable)	Single phase 2-wire commander with test tip, TEST and SAVE function keys for installation safety measurements.	-	-	✓	-	-	-	-	-	-	✓	-	✓	✓	-	-	-	-	-	-	-
	A 1270	Tip commander (for Smartec)	Single phase 2-wire commander with test tip, TEST and MEM function keys for installation safety measurements.	-	-	-	-	-	-	-	-	-	-	-	-	✓	✓	-	-	-	-	-	-
	A 1300	Tip commander, 3-wire (for Smartec)	Single phase 3-wire commander with test tip, TEST and MEM function keys for installation safety measurements.	-	-	-	-	-	-	-	-	-	-	-	-	✓	-	-	-	-	-	-	-
	A 1018	Current clamp (low range, leakage)	High accuracy current clamp 1000 A / 1 A with jaw opening 52 mm and fixed 1.5 m cable for both load and low range / leakage current measurement and for earth resistance measurement as well.	✓	✓	✓	✓	✓	-	-	-	-	✓	✓	-	-	✓	-	-	-	-	-	-
	A 1019	Current clamp	Current clamp 1000 A / 1 A with jaw opening 52 mm for general current measurements and in combination with A 1018 for earth resistance measurement without breaking the loop.	-	-	✓	-	✓	-	-	-	-	✓	✓	-	-	✓	-	-	-	-	✓	-
	A 1068	Connection cable for clamp, 1.5 m	Connection cable for connecting current clamp on the instrument MI 2093.	-	-	-	-	-	-	-	-	-	-	-	-	-	-	-	-	-	-	✓	-
	A 1074	Mini current clamp 200 A / 0.2 A	Mini current clamp 200 A / 0.2 A with jaw opening 15 mm for current measurement in confined spaces.	-	-	✓	-	✓	✓	-	-	-	✓	✓	-	-	✓	-	-	-	-	✓	-

✓ Option - Not available

Selection Guide for EIS Accessories

Photo	Part number	Description	Target application	MI 3108	MI 3109	MI 3105	MI 3101	MI 3102 BT	MI 3102 BT	MI 3100 SE	MI 3100 S	MI 3125 BT	MI 3125	MI 2086	MI 2088	MI 3121	MI 3122	MI 3123	MI 3110	MI 2126	MI 3103	MI 2093	A 1143
	A 1391	AC/DC Current clamp	AC/DC Current Clamp with 40 and 300 A range.	✓	✓	-	-	✓	-	-	-	-	-	-	-	-	-	-	-	-	-	-	-
	A 1011	Test lead, 3 x 1.5 m	3-wire test lead for measurements on single or three phase electrical installations.	✓	-	✓	✓	✓	✓	✓	✓	✓	✓	-	-	✓	-	-	-	-	-	-	-
	A 1021	Test lead, 4 x 1 m	4-wire test lead for measurements on electrical installations.	-	-	-	-	-	-	-	-	-	-	✓	✓	-	-	-	-	-	-	-	-
	A 1055	Test lead, 2 x 1.5 m	2-wire test lead for continuity and insulation resistance measurements on electrical installations.	-	-	-	-	-	-	-	-	-	-	-	-	✓	-	-	-	-	-	-	-
	A 1385	PV fused test lead	Test cable for simultaneous AC/DC power and efficiency measurements of PV inverters.	✓	✓	-	-	-	-	-	-	-	-	-	-	-	-	-	-	-	-	-	-
	S 2001	Earth test set, 4-wire, 20 m	Earth test set for earth resistance measurement on distance up to 20 m; set includes: test lead, 4 x 1 m; test lead, 20 m, 2 pcs; test lead, 4 m, 2 pcs; earth spikes, 4 pcs; soft carrying bag.	-	-	-	-	-	-	-	-	-	-	✓	✓	-	-	-	-	-	-	-	-
	S 2002	Earth test set, 4-wire, 50 m	Earth test set for earth resistance measurement on distance up to 50 m; set includes: test lead, 4 x 1 m; test lead, 50 m, 2 pcs; test lead, 4 m, 2 pcs; test lead, 1 m, 2 pcs; earth spikes, 4 pcs; carrying bag.	-	-	-	-	-	-	-	-	-	-	✓	✓	-	-	-	-	-	-	-	-
	S 2041	Earth test set, 4-wire, 50 m (for Smartec)	Earth test set for earth resistance measurement on distance up to 50 m; set includes: test lead, 50 m, 2 pcs; test lead, 4 m, 2 pcs; test lead, 1 m, 2 pcs; earth spikes, 4 pcs; soft carrying bag.	-	-	-	-	-	-	-	-	-	-	-	-	-	-	-	✓	-	-	-	-
	S 2026	Earth test set, 3-wire, 20 m	Earth test set for earth resistance measurement on distance up to 20 m; set includes: test lead, 20 m, 2 pcs; test lead, 4.5 m; earth spikes, 2 pcs; soft carrying bag.	✓	-	✓	✓	✓	✓	✓	✓	✓	✓	-	-	-	-	-	-	-	-	-	-
	S 2027	Earth test set, 3-wire, 50 m	Earth test set for earth resistance measurement on distance up to 50 m; set includes: test lead, 50 m, 2 pcs; test lead, 4.5 m; test lead, 1 m, 2 pcs; earth spikes, 2 pcs; soft carrying bag.	✓	-	✓	✓	✓	✓	✓	✓	✓	✓	-	-	-	-	-	-	-	-	-	-
	S 2058	Insulation test plates	Two in one: Test plates for measurement of floor and wall insulation, Δ625 cm ² (acc. to EN 60364-6) and measurement of semi conductivity, 2,5 kg, Ø65 mm (acc. to EN 61340-5-1).	-	-	✓	✓	✓	✓	✓	✓	✓	✓	✓	✓	✓	✓	-	-	✓	-	✓	-
	A 1052	PC SW EuroLink PRO (for MI 2086)	EuroLink PRO is a professional PC Software which enables downloading, data management and complete test report preparation.	-	-	-	-	-	-	-	-	-	✓	-	-	-	-	-	-	-	-	-	-

✓ Option - Not available

Selection Guide for EIS Accessories

Photo	Part number	Description	Target application	MI 3108	MI 3109	MI 3105	MI 3101	MI 3102H BT	MI 3102 BT	MI 3100 SE	MI 3125 BT	MI 3125	MI 2086	MI 2088	MI 3121	MI 3122	MI 3123	MI 3110	MI 2126	MI 3103	MI 2093	A 1143
	A 1290	PC SW EuroLink PRO Plus with USB and RS232-PS/2 cable	Professional PC Software EuroLink PRO Plus enables downloading, data management and complete test report preparation. Delivered with RS232-PS/2 and USB communication cables.	-	-	-	-	-	-	-	-	-	-	-	✓	✓	✓	-	-	-	-	-
	A 1291	PC SW EuroLink PRO with USB and RS232-PS/2 cable	PC Software EuroLink PRO enables downloading and test results management and printing of test reports. Delivered with RS232-PS/2 and USB communication cables.	-	-	-	-	-	-	-	-	-	-	-	✓	✓	✓	-	-	-	-	-
	A 1292	Upgrade code EuroLink PRO to EuroLink PRO Plus	Password for upgrading standard PC software EuroLink PRO to advanced PC SW EuroLink PRO Plus with professional report creation facility.	✓	✓	✓	✓	✓	✓	✓	-	-	-	-	✓	✓	✓	✓	-	-	-	-
	A 1431	EuroLink Android APP	EuroLink Android APP	-	-	✓	✓	✓	✓	✓	-	-	-	-	-	-	-	-	-	-	-	-
	A 1012	Test lead, green, 4 m	Extension test lead for continuity measurements.	✓	✓	✓	✓	✓	✓	✓	✓	✓	✓	-	-	-	-	✓	-	-	-	-
	A 1154	Test lead, black, 4 m	Extension test lead for earth and continuity measurements.	-	-	✓	✓	✓	✓	✓	✓	✓	✓	✓	-	-	-	✓	-	✓	✓	-
	A 1026	Test lead, red, 20 m	Extension test lead for continuity measurements.	-	-	✓	✓	✓	✓	✓	✓	✓	✓	✓	-	-	-	✓	-	✓	✓	-
	A 1153	Test lead, black, 20 m	Extension test lead for earth and continuity measurements.	-	-	✓	✓	✓	✓	✓	✓	✓	✓	✓	-	-	-	✓	-	✓	✓	-
	A 1164	Test lead, black, 50 m	Extension test lead for earth and continuity measurements.	-	-	✓	✓	✓	✓	✓	✓	✓	✓	✓	-	-	-	✓	-	✓	✓	-
	S 2009	Test lead set, 2 m, 4 pcs	Set of 4 test leads is intended for two clamp earth resistance measurement to connect current clamps on the instrument.	-	-	-	-	-	-	-	-	-	-	-	-	-	-	✓	-	-	-	-
	S 2012	Continuity test lead, 10 m, 2 pcs (red, black)	2 pieces of extension test lead for continuity measurements.	-	-	✓	✓	✓	✓	✓	✓	✓	✓	✓	-	-	-	✓	-	✓	✓	-
	S 2025	Test lead, 1.5 m, 2 pcs (black, red)	Connection leads for different measurements.	-	-	✓	✓	✓	✓	✓	✓	✓	✓	✓	-	-	-	✓	-	✓	✓	-

✓ Option - Not available

Selection Guide for EIS Accessories

Photo	Part number	Description	Target application	MI 3108	MI 3109	MI 3105	MI 3101	MI 3102H BT	MI 3102 BT	MI 3100 SE	MI 3125 BT	MI 3125	MI 2086	MI 2088	MI 3121	MI 3122	MI 3123	MI 3110	MI 2126	MI 3103	MI 2093	A 1143
	A 1013	Crocodile clip, black	Crocodile clip assures secure and permanent contact during the measurement on bus bars, fixing screws, etc.	-	-	✓	✓	✓	✓	✓	✓	✓	✓	✓	✓	✓	✓	-	-	-	✓	-
	A 1064	Crocodile clip, red	Crocodile clip assures secure and permanent contact during the measurement on bus bars, fixing screws, etc.	✓	✓	-	-	-	-	-	-	-	-	-	✓	-	-	-	-	✓	-	-
	A 1309	Crocodile clip, green	Crocodile clip assures secure and permanent contact during the measurement on bus bars, fixing screws, etc.	-	-	✓	✓	✓	✓	✓	✓	✓	✓	-	-	✓	-	-	-	-	-	-
	A 1310	Crocodile clip, blue	Crocodile clip assures secure and permanent contact during the measurement on bus bars, fixing screws, etc.	-	-	✓	✓	✓	✓	✓	✓	✓	✓	-	-	✓	-	-	-	-	-	-
	A 1014	Test probe, black	Test probe with Ø 4 mm connection is suitable for performing measurements both in mains outlets and in situations when no schuko outlet is present.	-	-	✓	✓	✓	✓	✓	✓	✓	✓	✓	✓	✓	✓	-	-	✓	✓	-
	A 1015	Test probe, blue	Test probe with Ø 4 mm connection is suitable for performing measurements both in mains outlets and in situations when no schuko outlet is present.	✓	✓	✓	✓	✓	✓	✓	✓	✓	✓	✓	-	-	✓	-	-	-	-	-
	A 1016	Test probe, red	Test probe with Ø 4 mm connection is suitable for performing measurements both in mains outlets and in situations when no schuko outlet is present.	✓	✓	-	-	-	-	-	-	-	-	-	✓	✓	-	-	-	✓	-	-
	A 1062	Test probe, green	Test probe with Ø 4 mm connection is suitable for performing measurements both in mains outlets and in situations when no schuko outlet is present.	✓	✓	✓	✓	✓	✓	✓	✓	✓	✓	✓	-	-	✓	-	-	-	-	-
	A 1198	Magnetic contact probe	Test probe with magnetic contact provides reliable contact with metal surface during the measurement.	✓	✓	✓	✓	✓	✓	✓	✓	✓	✓	✓	✓	✓	✓	-	-	✓	-	-
	A 1201	Insulated rod for CONTINUITY measurement	Insulated rod enables insulation resistance and continuity measurement on hard-to-reach objects, e.g. luminaries.	✓	✓	✓	✓	✓	✓	✓	✓	✓	✓	✓	✓	✓	✓	-	-	-	✓	-
	A 1202	Additional extension part for A 1201	Additional extension part for Insulated rod for CONTINUITY measurement A 1201.	✓	✓	✓	✓	✓	✓	✓	✓	✓	✓	✓	✓	✓	✓	-	-	-	✓	-
	A 1006	Soft carrying bag	Large soft carrying bag for transport and storage of test instrument and belonging accessories.	-	-	-	-	-	-	-	-	-	✓	✓	-	-	-	-	-	-	-	-

✓ Option - Not available

Selection Guide for EIS Accessories

Photo	Part number	Description	Target application	MI 3108	MI 3109	MI 3105	MI 3101	MI 3102H BT	MI 3102 BT	MI 3100 SE	MI 3100 S	MI 3125 BT	MI 3125	MI 2086	MI 2088	MI 3121	MI 3122	MI 3123	MI 3110	MI 2126	MI 3103	MI 2093	A 1143
	A 1289	Soft carrying bag	Large soft carrying bag for transport and storage of test instrument and belonging accessories.	-	-	✓	✓	✓	✓	✓	✓	✓	-	-	✓	✓	✓	✓	-	-	-	-	-
	A 1020	Small soft carrying bag	Small soft carrying bag for transport and storage of test instrument or accessories.	-	-	-	-	-	-	-	-	-	-	-	-	-	-	-	-	-	-	✓	-
	A 1271	Small soft carrying bag	Small soft carrying bag for transport and storage of test instrument or accessories.	-	-	-	-	-	-	-	✓	✓	-	-	✓	✓	✓	-	-	-	-	-	-
	A 1302	Set of carrying straps	Set of carrying straps for carrying the measuring instrument around the neck allowing free hand use of the tester.	-	-	-	-	-	-	-	✓	✓	-	-	✓	✓	✓	-	-	-	-	-	-
	A 1303	Soft hand strap	Soft hand strap for holding the instrument.	-	-	-	-	-	-	-	✓	✓	-	-	✓	✓	✓	-	-	-	-	-	-
	A 1245	Holder for commander	Holder enables free hand operation with the tester by fixing the test commander and other test cables when not in use.	-	-	✓	✓	✓	✓	✓	-	-	-	-	-	-	-	-	-	-	-	-	-
	A 1110	Three phase adapter	3-phase test adapter for installation safety testing on 3-phase sockets type 16 A 3CEE.	✓	✓	✓	✓	✓	✓	✓	✓	✓	✓	-	-	-	✓	-	-	-	-	-	-
	A 1111 A 1215 (for MI 2150)	Three phase adapter with selection switch for installation safety testing on 3-phase sockets type 16 A 3CEE. The adapter allows seamless switching between measurements.	3-phase adapter with selection switch for installation safety testing on 3-phase sockets type 16 A 3CEE. The adapter allows seamless switching between measurements.	✓	✓	✓	✓	✓	✓	✓	✓	✓	✓	-	-	-	✓	-	-	-	-	-	-
	A 1171	RS232 / USB adapter with 1 m cable	RS232 / USB adapter for instruments without USB communication port.	-	-	-	-	-	-	-	-	-	-	✓	✓	-	-	-	-	-	-	-	-
	A 1436	Bluetooth dongle	External Bluetooth adapter for wireless connection between Metrel's instruments and Smart phones, tablets and PCs.	✓	✓	✓	✓	-	-	-	-	-	-	-	-	-	-	-	-	-	-	-	-
	A 1017	Communication cable RS232	RS232 interface cable for connecting the instrument with the PC.	-	-	-	-	-	-	-	-	-	-	✓	✓	-	-	-	-	-	-	-	-
	A 1105	Barcode scanner	Barcode scanner for identification of barcode labelled installation structure elements like sockets, switches, fuses, switchboards, etc.	✓	✓	✓	✓	-	-	-	-	-	-	-	-	-	-	-	-	-	-	-	-

✓ Option - Not available

Selection Guide for EIS Accessories

Photo	Part number	Description	Target application	MI 3108	MI 3109	MI 3105	MI 3101	MI 3102H BT	MI 3102 BT	MI 3100 SE	MI 3100 S	MI 3125 BT	MI 3125	MI 2086	MI 2088	MI 3121	MI 3122	MI 3123	MI 3110	MI 2126	MI 3103	MI 2093	A 1143
	AM 1337	RFID Reader	RFID reader	✓	✓	-	-	-	-	-	-	-	-	-	-	-	-	-	-	-	-	-	-
	S 2055	Set of 2 flat contact clamps	Flat contact clamp with integrated fuse for a fast and safe contact on flat conductor bars, eg. in low voltage installations. With red-colored ring.	-	-	-	-	-	-	-	-	-	-	-	-	-	-	-	-	-	-	-	✓
	S 2056	RFID HGL	Flat contact clamp for a fast and safe contact on flat conductor bars, eg. in low voltage installations.	-	-	-	-	-	-	-	-	-	-	-	-	-	-	-	-	-	-	-	✓
	S 2057	Set 5 of crocodile clips	Set of 3 black and 2 red crocodile clips, which assures secure and permanent contact during the measurement on bus bars, fixing screws, etc.	-	-	-	-	-	-	-	-	-	-	-	-	-	-	-	-	-	-	-	✓

✓ Option - Not available

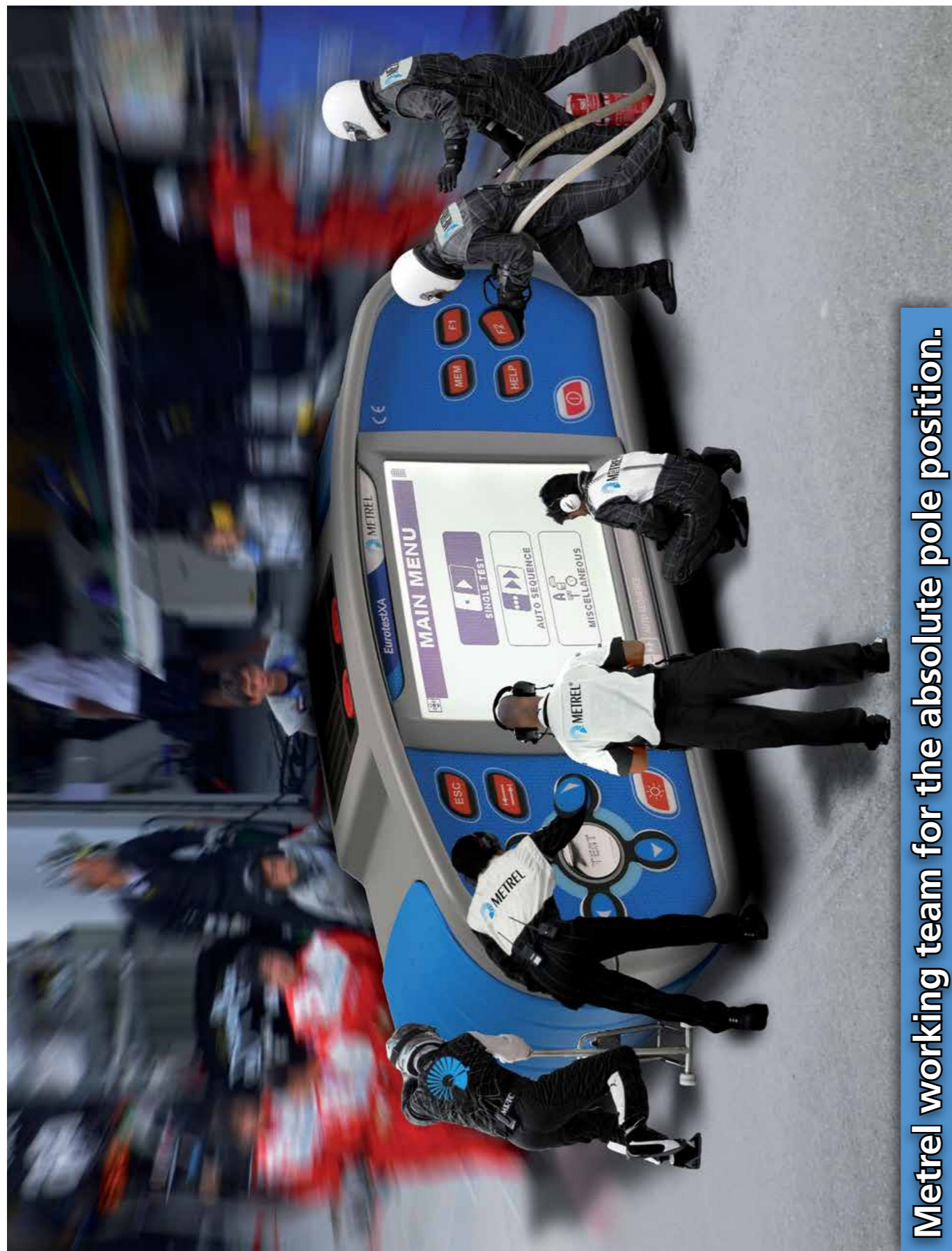

Metrel working team for the absolute pole position.

MEASURING INSTRUMENTS AND TESTERS

- Electrical Installation Safety
- High Voltage Insulation / Continuity / Earth
- Appliance / Machine / Switchboard Safety
- Power Quality Analysis
- LAN Cabling Certification
- Indoor Environment Quality
- Digital Multimeters / Clamp Meters
- Voltage and Continuity Testers
- Variable transformers / Equipment for laboratories and Schools

GOOD TO KNOW

High Voltage Insulation / Continuity / Earth	2	-	02
Selection Guide for CONTINUITY Insulation Testers	2	-	06
Selection Guide for HV Insulation Testers	2	-	07
EARTH TESTER			
MI 3295 Step Contact Voltage Measuring System	2	-	08
CONTINUITY TESTERS			
MI 3252 MicroOhm 100A	2	-	10
MI 3250 MicroOhm 10A	2	-	12
MI 3242 MicroOhm 2A	2	-	14
HIGH VOLTAGE INSULATION TESTERS			
MI 3210 TeraOhmXA 10 kV NEW	2	-	16
MI 3200 TeraOhm 10 kV	2	-	18
MI 3201 TeraOhm 5 kV Plus	2	-	20
MI 2077 TeraOhm 5 kV	2	-	22
MI 3202 GigaOhm 5 kV	1	-	24
MI 3121H 2,5 kV Insulation / Continuity	2	-	26
PC SOFTWARE			
HVLink PRO	2	-	28
DEMONSTRATION BOARD			
MI 3299 HV demo BOX	2	-	30
Selection Guide for HV Accessories	2	-	31

High Voltage Insulation / Continuity / Earth
High Voltage Insulation Resistance Diagnostics / Accurate Low Resistance Measurements

HV, Step / Contact Voltage and Earth Resistance

Find out more about Insulation measurement techniques

Insulation is a material property and is measured as insulation resistance. Characteristics of insulation tend to change through time, normally getting worse by ageing. Various physical phenomena have influence on insulation characteristics, like temperature, dirt, humidity, mechanical and electrical stresses, high-energy radiation, etc. Harsh installation environments, especially those with temperature extremes and / or chemical contamination, cause further deterioration.

Safety, operability and reliability are the most important parameters of electrical device containing insulation and this is the reason why insulation has to be measured. Insulation is measured in the initiating phase of electrical device and also later during maintenance works or repairing, and measurements are of simple and diagnostic type.

Basics of insulation measurements

According to Ohms law,

$$I = \frac{U}{R}$$

the current does not depend on time. But a simple measurement of insulation resistance shows that the current depends on time. The reasons for such behavior of the current are different phenomena in insulation material after a voltage is applied. A typical insulation model is presented in figure below.

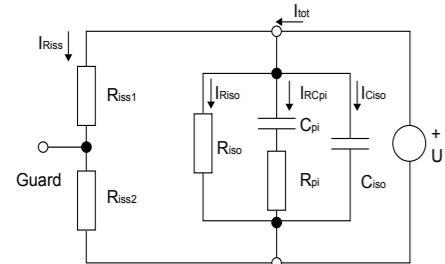

Insulation resistance and capacitance model, partial and total currents

U	Applied test voltage
Riss1 & Riss2	Surface leakage resistances
Riso	Insulation resistance
Ciso	Insulation capacitance
Rpi	Polarization resistance
Cpi	Polarization capacitance

The total current I_{tot} comprises of four partial currents.

I_{tot}	Total current
I_{Riss}	Surface leakage current
I_{Riso}	Insulation leakage current
I_{RCpi}	Polarization absorption current
I_{Ciso}	Capacitance charging current

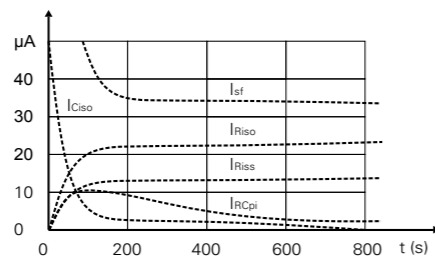

Typical current / time diagram for a real voltage source

In practice the insulation resistance measurement instrument does not include an ideal voltage source. At the start all available instrument power is used to charge the capacitor $Ciso$ for short period. The voltage on connection points drops because of this.

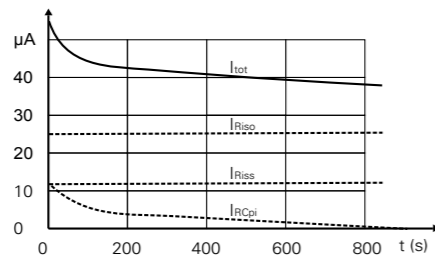

Current diagram for an ideal voltage source

When DC voltage is suddenly applied to the insulation, the test current will start at a high value, gradually decrease with time, and finally level off to a stable value. The leakage current does not change with time, and this current is the primary factor on which the insulation quality may be judged.

Types of insulation testing

Various types of insulation testing are used to determine insulation characteristics.

DC voltage testing and AC voltage testing AC testing

AC testing is more suitable for performing withstanding or dielectric tests. While DC test gives more qualitative picture about the tested insulation.

Spot reading test

This is the simplest and fastest way of insulation resistance testing. Unfortunately only one test, with no prior tests, can be only a rough guide as to how good or bad the insulation is. In this test the instrument is connected across the insulation of the tested item. A test voltage is applied for a fixed period of time; usually a reading is taken after 1 minute as can be seen in figure.

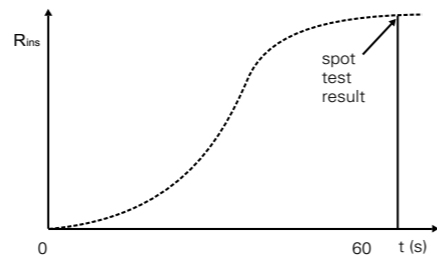

Typical insulation resistance/time diagram for a spot reading test

The spot reading test should only be carried out when the insulation temperature is above the dew point.

METREL's hint:

The lower limit of insulation resistance may often be established according to the one mega-ohm rule:

Insulation resistance should be at least 1 MΩ for each kilovolt of operating voltage, but not less than 1 MΩ (e.g. a motor rated at 5 kV working voltage should have a minimum resistance of 5 MΩ).

Time rise method / polarization index / dielectric absorption ratio

When test voltage is applied a bad insulation causes drop of the value R_{iso} and the increasing in the insulation leakage current I_{Riso} . The absorption current is masked by a high insulation leakage current. The insulation leakage current stays at a fairly constant value and the resistance reading stays low. A good insulation shows continuous increasing of the resistance over a period. This is caused by the absorption that can be clearly seen. The absorption effect lasts far longer than the time required for charging the capacitance of the insulation.

HV, Step / Contact Voltage and Earth Resistance

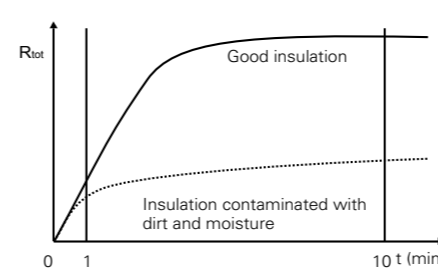

Time diagrams of good and bad insulation tested with the time-rise method

The result of this measurement is polarization index (PI), which is defined as the ratio of measured resistance in two time slots (typically the ratio is 10 min value to 1 min value at a continuous measurement).

PI value	Tested material status
1 - 1.5	Not acceptable (older types)
2 - 4 (typically 3)	Considered as good insulation (older types)
4 (very good insulation)	Modern type of good insulation systems

Typical values of polarization index

$$PI = \frac{R_{tot}(10 \text{ min})}{R_{tot}(1 \text{ min})}$$

The results of this method don't depend on temperature and the method can give a conclusive information without comparing records of past tests.

Dielectric absorption ratio (DAR) is similar to the polarization index method. The only difference are periods for capturing the results which are usually 30 s (or 15 s) and 1 minute.

DAR value	Tested material status
< 1	Bad insulation
$1 \leq DAR \leq 1.25$	Acceptable insulation
> 1.4	Very good insulation

Typical values for dielectric discharge

$$DAR = \frac{R_{tot}(1 \text{ min})}{R_{tot}(30 \text{ s})}$$

Dielectric discharge

It is difficult to determine the polarization index if polarization absorption current I_{RCpi} is small compared to the others. Rather than measuring the polarization current during an insulation test, the dielectric discharge (DD) test can be performed. DD test is carried out after the completion of the insulation resistance measurement. Typically the insulation

material is left connected to the test voltage for 10 ... 30 min and then discharged before the DD test is carried out. After 1 min a discharge current is measured to detect the charge re-absorption of the insulation material. A high re-absorption current indicates contaminated insulation (mainly based on moisture).

DD value	Tested material status
> 4	Bad
2 - 4	Critical
< 2	Good

Values of dielectric discharge

$$DD = \frac{I_{dis}(1 \text{ min})}{U C_{iso}}$$

$I_{dis}(1 \text{ min})$	discharging current measured 1 min after the voltage was switched off
U	test voltage
C_{iso}	capacitance of tested object

Typical values of dielectric discharge

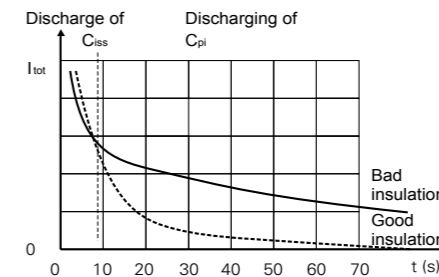

The current/time diagram of a good and bad insulation tested with dielectric discharge method

The dielectric discharge test is very useful for testing a multi-layer insulation.

Step voltage insulation resistance test

Testing with a voltage far below the one expected in service often reveals moisture and dirt in insulation, whereas effects of ageing or mechanical damage of a fairly clean and dry insulation may not be revealed at such low stress. The step voltage method is very useful when testing with an instrument that has a lower test voltage than the rated test voltage of the tested item. In other words, step voltage test gives us useful results even in case we are not able to stress insulation with nominal electrical voltages.

The device under test is exposed to different test voltages that are applied in steps. The voltage starts at the lowest value and increases with defined steps up to the highest level.

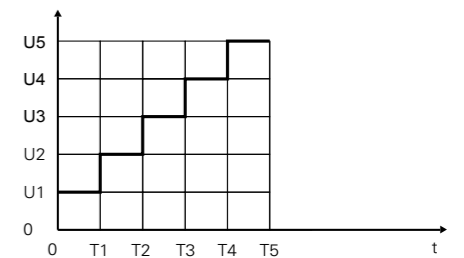

Typical measuring procedure for step voltage measurement

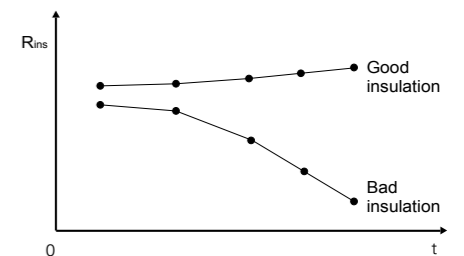

Typical step voltage measurement results

The shape of the curve represents the quality of insulation:

- The resistance of a damaged insulation will rapidly decrease.
- A good insulation has approximately constant resistance at all voltages.

Withstanding voltage test

The withstanding voltage test is one of the basic insulation tests. Its principle is very simple - the voltage is stressing the device under test until the required test time or breakdown of insulation is reached.

The time gradient of increasing voltage, maximum voltage and the time of maximum test voltage are very important and depend on the type of device under test. These parameters are defined in adequate standards. The indication of a breakdown is a sudden increase in the current through insulation, beyond the predefined limit.

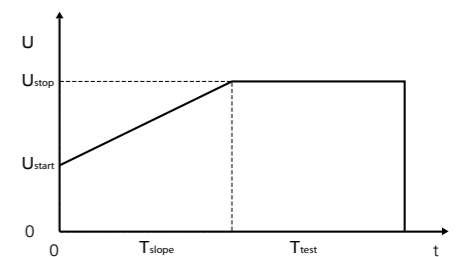

Measuring procedure for withstanding voltage measurement.

HV, Step / Contact Voltage and Earth Resistance

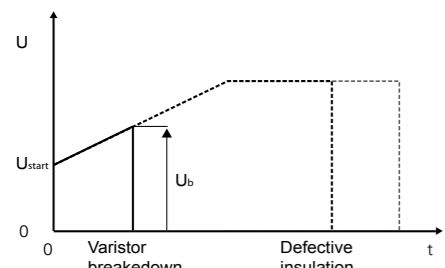

Measuring procedure for withstanding voltage measurement.

Typical connections for:

Power cables

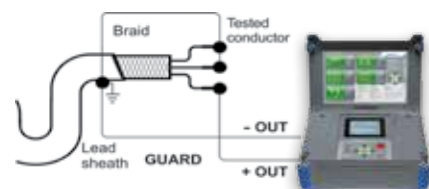

Measurement of insulation resistance of cable between one conductor against other conductors including lead sheath

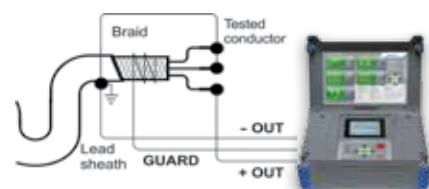

Measurement of insulation resistance of cable between one conductor against other conductors and lead sheath using the guard terminal to avoid leakage effects at the end of cable

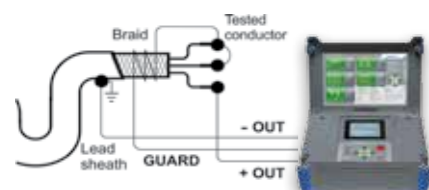

Measurement of insulation resistance of a cable between a conductor and lead sheath

Control and communication cable

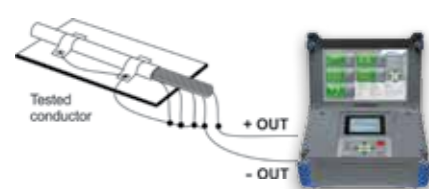

Measurement of insulation resistance between one lead of communication cable against other leads and sheath

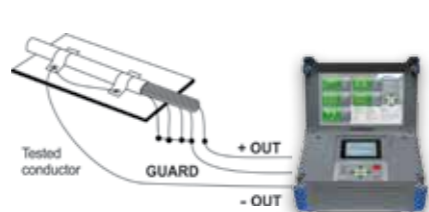

Measurement of insulation resistance of communication cable using the guard terminal. Resistance is measured between a lead and sheath

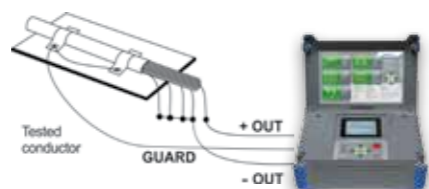

Measurement of insulation resistance of communication cable using the guard terminal. Resistance is measured between one lead and other leads

Home appliances and similar electrical devices

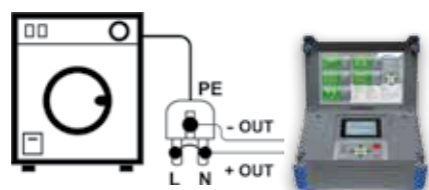

Measurement of household device, protection class I and class II

Induction motor

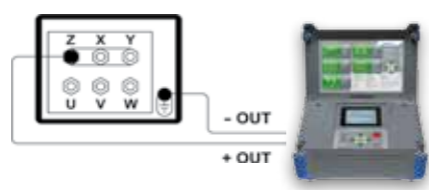

Measurement of insulation resistance of induction motor between all three phases against metal enclosure

Power transformer

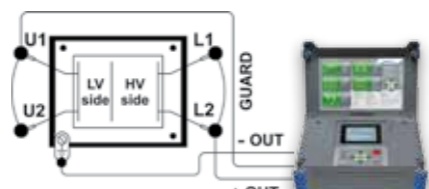

The simplest measurement of insulation resistance of transformer

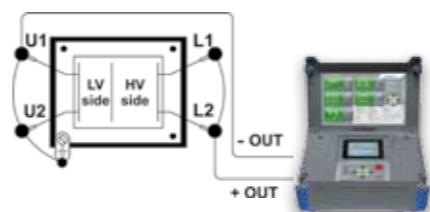

Measurement of insulation resistance on one HV winding against metal enclosure

Earthing

Correct earthing of exposed conductive parts of the object assures that the voltage on them stays below dangerous level in case of a fault. If fault happens a fault current will flow through the earthing electrode.

A typical voltage distribution occurs around the electrode (the "voltage funnel"). Fault currents close to power distribution objects (substations, distribution towers, plants) can be very high, up to 200 kA. This can result in dangerous step and contact voltages. If there are underground metal connections (intended or unknown) the voltage funnel can get atypical forms and high voltages can occur far from the point of failure. Therefore the voltage distribution in case of a fault around this objects must be carefully analyzed.

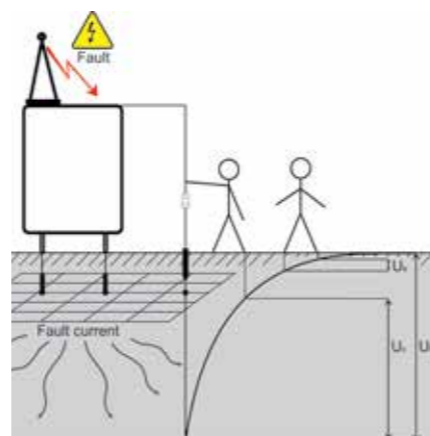

Dangerous voltages on a faulty earthing system

Standard IEC 61140 defines following maximum allowed time / contact voltage relations:

HV, Step / Contact Voltage and Earth Resistance

Maximum time of exposure	Voltage
> 5 s to ∞	$U_c \leq 50 \text{ V}_{ac}$ or $\leq 120 \text{ V}_{dc}$
< 0.4 s	$U_c \leq 115 \text{ V}_{ac}$ or $\leq 180 \text{ V}_{dc}$
< 0.2 s	$U_c \leq 200 \text{ V}_{ac}$
< 0.04 s	$U_c \leq 250 \text{ V}_{ac}$

Maximum time durations vs fault voltage

For a longer exposure the touch voltages must stay below 50 V.

During the measurement a test current is injected into the earth through an auxiliary probe. A higher injected current improves the immunity against spurious earth currents.

Step voltage measurement

The measurement of step voltage is performed between two ground points at a distance of 1 m. The 25 kg measuring probes simulates the feet. The voltage between the probes is measured by a voltmeter with an internal resistance of 1 kΩ that simulates the body resistance.

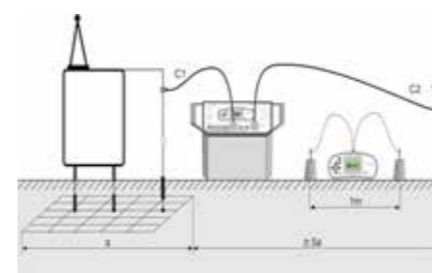

Step voltage measurement

Contact voltage measurement

The measurement of contact voltage is performed between an earthed accessible metal part and ground. The voltage between the probes is measured by a voltmeter with an internal resistance of 1 kΩ that simulates the body resistance.

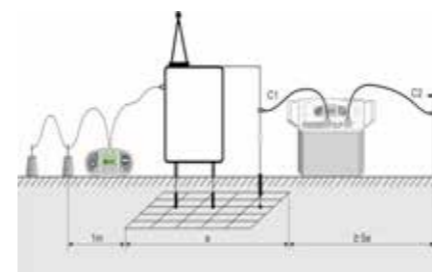

Contact voltage measurement

Earth resistance measurement

For the earthing resistance test a voltage and current probe (serves as auxiliary earth) are used. Because of the voltage funnel it is important that the test electrodes are placed correctly.

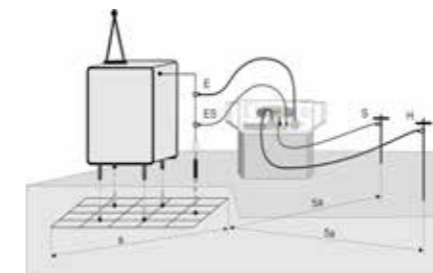

Earth resistance measurement

Specific earth resistance

For the specific earth resistance the test current is injected through two current probes (C1/H and C2/E).

The voltage probes S and ES must be placed between the current probes (equidistance 'a' between probes must be considered). Using different distances between the test probes means that the material at different depths is measured. By increasing the distances 'a' a deeper layer of ground material is measured.

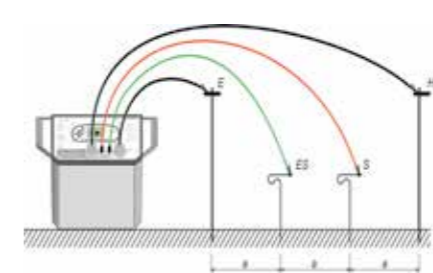

Specific earth resistance measurement

Low Resistance Measurement

Four-wire Kelvin method

When measuring resistance <math> < 20 \Omega </math> it is advisable to use a four-wire Kelvin measurement technique for achieving high accuracy. By using this type of measurement configuration the test lead resistance is not included in the measurement, and the need for lead calibrating and balancing is eliminated.

Typical connections for:

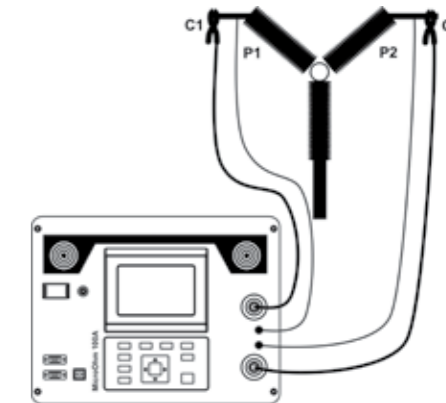

Circuit breaker connection

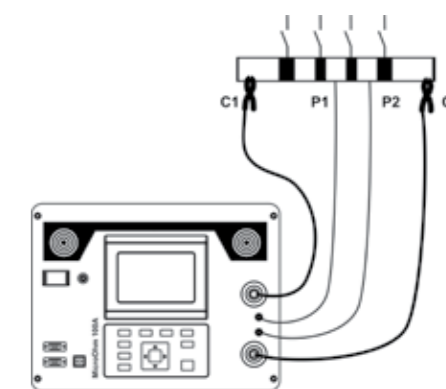

Bus bar connection

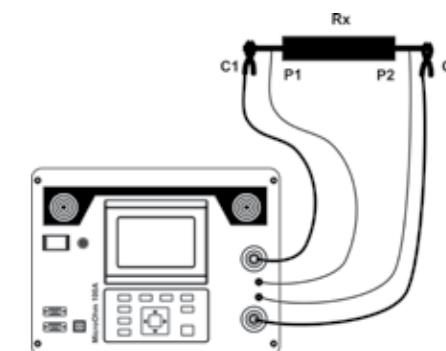

Connecting instrument to the measured device

Selection Guide for CONTINUITY Insulation Testers

Part No.	MI 3252 MicroOhm 100A	MI 3250 MicroOhm 10A	MI 3242 MicroOhm 2A
MEASUREMENTS			
Measuring range	1 nΩ ... 20 Ω	100 nΩ ... 2 kΩ	1 μΩ ... 200 Ω
No. of ranges	6	7	6
Current into load	2 mΩ at 100 A	200 mΩ at 10 A	1 Ω at 2 A
Highest resolution	1 nΩ	0.1 μΩ	1 μΩ
Basic accuracy	0.25 %	0.25 %	0.25 %
Test current	100 A, 50 A, 10 A, 1 A, 100 mA	10 A, 1 A, 100 mA, 10 mA, 1 mA	2 A, 100 mA, 10 mA
OTHER FEATURES			
Measurement modes	Single, Continuous	Single, Automatic, Inductive, Continuous	Single, Automatic, Inductive, Continuous
Test method	4-wire, unidirectional	4-wire, Bidirectional	4-wire, Bidirectional
Autoranging	-	✓	✓
PASS / FAIL indication	✓	✓	✓
Temperature compensation	-	✓	-
COMMUNICATION PORTS			
RS232	✓	✓	✓
USB	✓	✓	✓
MEMORY, SOFTWARE			
Memory	✓	✓	✓
Number of memory locations	1000 / 2 levels	1000	1500
Software	HVLink PRO	HVLink PRO	HVLink PRO
GENERAL DATA			
Display type	Graphical LCD	Graphical LCD	Graphical LCD
Backlight	✓	✓	✓
Safety category	CAT IV / 50 V CAT II / 300 V	CAT IV / 300 V CAT II / 300 V	CAT IV / 300 V CAT III / 600 V
Rechargeable batteries	✓	✓	✓
Battery	12 V / 12 Ah	6 x NiMH, type HR14	6 x NiMH, type AA
Built-in battery charger	-	✓	✓
Low battery indication	✓	✓	✓
Mains voltage	115 / 230 V AC, 50 / 60 Hz, 200 VA	90-260 V AC, 45-65 Hz, 50 W	-
Weight	11.8 kg	2.8 kg	0.8 kg
Dimensions (mm)	410 x 175 x 370	310 x 130 x 250	140 x 80 x 230

Selection Guide for HV Insulation Testers

Part No.	NEW MI 3210 TeraOhmXA 10 kV	MI 3200 TeraOhm 10 kV	MI 3201 TeraOhm 5 kV Plus	MI 2077 TeraOhm 5 kV	MI 3202 GigaOhm 5 kV	MI 3121H Insulation/ Continuity
MEASUREMENTS						
Test voltage range	50 V _{dc} ... 10 kV _{dc}	500 V _{dc} ... 10 kV _{dc}	250 V _{dc} ... 5 kV _{dc}	250 V _{dc} ... 5 kV _{dc}	250 V _{dc} ... 5 kV _{dc}	100 V _{dc} ... 2.5 kV _{dc}
Voltage steps	50 V	25 V	25 V	50 V	250 V; 500 V; 1 kV; 2.5 kV; 5 kV	100 V; 250 V; 500 V; 1 kV; 2.5 kV
Insulation resistance measuring range	20 TΩ	10 TΩ	10 TΩ	5 TΩ	1 TΩ	100 GΩ
Calculation of DD, DAR, PI	✓	✓	✓	✓	-	✓
Withstanding voltage test	✓	✓	✓	✓	-	-
Voltage ramp test	✓	✓	✓	✓	-	-
Leakage current measurement	✓	✓	✓	✓	-	-
Capacitance measurement	✓	✓	✓	✓	-	-
Short circuit / charge current	5 mA	5 mA	5 mA	1.4 mA	5 mA	3 mA
Voltage measurement AC / DC	up to 600 V	up to 600 V	up to 600 V	up to 600 V	up to 600 V	up to 550 V
OTHER FEATURES						
Programmable timer	✓	✓	✓	✓	-	✓
Automatic discharge after test	✓	✓	✓	✓	✓	✓
Graph R(t)	✓	✓	✓	-	-	-
Bar graph	✓	✓	✓	✓	✓	✓
Auto adjustment function	✓	✓	✓	✓	✓	✓
Auto ranging	✓	✓	✓	✓	✓	✓
Audible warnings	✓	✓	✓	✓	✓	✓
Guard terminal	✓	✓	✓	✓	✓	-
Shielded test leads	✓	✓	✓	Option	✓	-
COMMUNICATION PORTS						
USB/ RS232	✓ / ✓	✓ / ✓	✓ / ✓	Option / ✓	- / -	- / -
BLOETOOTH	✓	-	-	-	-	-
MEMORY, SOFTWARE						
Memory	✓	✓	✓	✓	-	-
Number of memory locations	1000	1000	1000	1000	-	1500
Software	HVLink PRO	Option (HVLink PRO)	Option (HVLink PRO)	Option (TeraLink)	-	Option (EuroLink PRO)
GENERAL DATA						
Display type	Graphical LCD	Graphical LCD	Graphical LCD	Graphical LCD	Custom LCD	Custom LCD
Backlight	✓	✓	✓	✓	✓	✓
Safety category	CAT IV / 600 V	CAT IV / 600 V	CAT IV / 600 V	CAT III / 600 V	CAT IV / 600 V	CAT III / 600 V; CAT IV / 300 V
Rechargeable batteries	✓	✓	✓	Option	✓	✓
Built-in battery charger	✓	✓	✓	✓	✓	-
Low battery indication	✓	✓	✓	✓	✓	✓
Battery life (no load connected)	4 h at 10 kV	4 h at 10 kV	4 h at 5 kV	4 h at 5 kV	4 h at 5 kV	13 h
Weight	5.5 kg	5.5 kg	3 kg	2.1 kg	3 kg	850 g
Dimensions (mm)	345 x 160 x 335	345 x 160 x 335	310 x 130 x 250	265 x 110 x 185	310 x 130 x 250	140 x 80 x 230

MI 3295 Step Contact Voltage Measuring System

The MI 3295 Step Contact Voltage Measuring System is a voltage measuring system intended for testing and verification of protective earthing of power stations, substation and other power systems. The system consists of Station for current generation and autonomous voltage Meter. Due to high test current (up to 55 A) and effective noise cancellation the MI 3295 ensures very accurate and stable measurements of Step and Contact Voltages with the resolution down to 10 μ V. A few voltmeters can be used simultaneously for faster analysis of voltage distribution around the tested object. All test results and parameters can be saved into the instrument's memory for further downloading, analysis and test report printing with the help of the PC SW HVLink PRO.

MEASURING FUNCTIONS:

- Step voltage;
- Contact voltage;
- Specific earth resistance;
- Earth resistance.

KEY FEATURES:

- **Accurate:** high accuracy of the measurements due to a high current of up to 50 A and effective suppression of noise.
- **Noise immunity:** excellent immunity even against changing earth currents.
- **Autonomous Step Voltage meter:** no need for long potential leads; a few meters can be used simultaneously.
- **Safe:** high safety due to low output voltage (55 V).
- **Low weight:** the weight of the Station is 29.5 kg only.
- **Memory:** up to 1000 test results can be saved into the 3-level internal memory of the system.
- **PC SW HVLink PRO** included in the standard set enables downloading and analysis of results and printing of test reports.



APPLICATION:

Measurement of protective earthing of:

- Power stations;
- Substations;
- Distribution towers;
- Other power systems.

STANDARDS:

Functionality:

RAT 2008;
HD 673 N4;
ANSI/IEEE Std 81;
EN 61557-5

Electromagnetic compatibility:

EN 61326

Safety:

EN 61010-1; EN 61010-031

STANDARD SET:

- Instrument MI 3295M
- Instrument MI 3295S
- Mains cable
- Step voltage probe (25 kg), 2 pcs
- Current earth spike
- Potential earth spike
- Current test lead, 50 m, black, 10 mm², with crocodile clip, on wheel
- Current test lead, 10 m, black, 10 mm², with crocodile clip
- Test lead, black, 2 x 3 m
- Test lead, green, 10 m
- Test lead, black, 1.5 m
- Test lead, red, 50 m
- Connection lead with crocodile clip, red, 1 m
- Crocodile clip, 4 pcs
- RS232 cable
- USB cable
- Soft carrying bag, 2 pcs

- Soft carrying neck belt
- NiMH battery cells, type AA, 6 pcs
- Power supply adapter
- CD with instruction manual and PC SW HVLink PRO
- Instruction manual
- Calibration certificate



TECHNICAL SPECIFICATION:

Function	Measuring range	Resolution	Accuracy
Step voltage, Contact voltage (measuring range U _m)	0.01 ... 19.99 mV	0.01 mV	±(2 % of reading + 2 digits)
	20.0 ... 199.9 mV	0.1 mV	±(2 % of reading + 2 digits)
	200 ... 1999 mV	1 mV	±(2 % of reading + 2 digits)
	2.00 ... 19.99 V	0.01 V	±(2 % of reading + 2 digits)
	20.0 V ... 59.9 V	0.1 V	±(2 % of reading + 2 digits)
Step voltage, Contact voltage (calculated measuring range U)	0.0 ... 199.9 V	0.1 V	calculated value*
	200 ... 999 V	1 V	
Test current	55 A max		
Test voltage	< 55 V		
Test frequency	55 Hz		
Current	0.00 ... 9.99 A	0.01 A	±(3 % of reading + 5 digits)
	10.0 ... 99.9 A	0.1 A	±(3 % of reading + 3 digits)
Resistance to earth	0.001 ... 1.999 Ω	0.001 Ω	±(2 % of reading + 5 digits)
	2.00 ... 19.99 Ω	0.01 Ω	±(2 % of reading + 5 digits)
	20.0 ... 99.9 Ω	0.1 Ω	±(2 % of reading + 5 digits)
	100.0 ... 199.9 Ω	0.1 Ω	±5 % of reading)
Specific earth resistance	0.00 ... 9.99 Ω m	0.01 Ω m	Calculated value, consider accuracy of Resistance to earth function.
	10.0 ... 99.9 Ω m	0.1 Ω m	
	100 ... 999 Ω m	1 Ω m	
	1.00 k ... 9.99 k Ω m	10 Ω m	
	10.0 k ... 99.9 k Ω m	100 Ω m	
Open circuit voltage	< 50 V _{Ac}		
Test current	< 7.5 A		
Test frequency	55 Hz		
STATION			
Power supply	230 V / 50 or 60 Hz		
Communication port	RS232		
Memory	1000 memory locations		
Overtoltage category	CAT II / 300 V		
Measuring category	CAT IV / 50 V		
Protection degree	IP 30		
Display	LCD with backlight (128 x 64 dots)		
Dimensions	563 x 275 x 257 mm		
Weight	29.5 kg		
METER			
Power supply	6 x 1.2 V rechargeable batteries, type AA		
Communication ports	USB, RS232		
Memory	1500 memory locations		
Measuring category	CAT IV / 50 V		
Protection degree	IP 40		
Display	LCD with backlight (128 x 64 dots)		
Dimensions	230 x 103 x 115 mm		
Weight	1.3 kg		

*Displayed Step / Contact voltage is obtained on base of calculation:
 $U_S = U_{meas} \cdot I_{fault} / I_{gen}$; $U_C = U_{meas} \cdot I_{fault} / I_{gen}$;
 I_{fault} (selectable): 1 A ... 200 kA

MI 3252 MicroOhm 100A

The MI 3252 MicroOhm 100A is portable low resistance ohmmeter used to measure low contact resistances of circuit breakers, switches and busbars joints using test current from 100 mA to 100 A. Used 4-lead Kelvin testing method ensures very high accuracy of results (0.25%) due to elimination of test leads resistance. The instrument can be powered from both mains supply and internal battery. PC SW HVLink PRO supplied as a standard accessory enables downloading, analysis and export of test results and printing of test reports.

MEASURING FUNCTIONS:

- Resistance measurement with adjustable test current (100 mA ... 100 A);
- Voltage drop measurement.

KEY FEATURES:

- **Accurate:** 1 nΩ best resolution with 0.25% accuracy.
- **Bar graph:** on screen resistance bar graph.
- **Battery powered:** the instrument enables measurements with 100 A for up to 10 minutes when powered from internal battery only.
- **Safe:** sustain external voltages in case of wrong connection, protection level (CAT IV / 50 V); automatically detects continuity in current circuit.
- **Single and continuous** measuring modes.
- **Custom limits:** the limits can be set for PASS or FAIL evaluation of test result.
- **Portable:** rugged carrying case with a handle and lightweight design (less than 12 kg) enable easy moving the instrument between sites.
- **High protection degree:** IP 64.
- **Memory:** built-in memory enables storage of up to 1000 test results.
- **Downloadable:** downloads test results via RS232 or USB cable directly to the PC with the help of the HVLink PRO software.

APPLICATION:

Measurement the resistance of:

- High, middle and low voltage circuit breakers;
- High, middle and low voltage disconnecting switches;
- High current busbar joints;
- Cable splices;
- Welding joints.

STANDARDS:

Functionality:

IEC 62271-100;
IEC 62271-1;
ANSI C37.09;
ASTM B 539;
NMEA AB 4-1996;
El Real Decreto 223/2008

Electromagnetic compatibility:

IEC 61326-1 Class B

Safety:

EN 61010-1



TECHNICAL SPECIFICATION:

Function	Measuring range	Resolution	Accuracy	Current	
Resistance	10.000 ... 199.999 μΩ	1 nΩ	±0.25 % of reading	100 A	
	0.20000 ... 1.99999 mΩ	10 nΩ	±0.25 % of reading	100 A / 50 A	
	2.0000 ... 19.9999 mΩ	100 nΩ	±0.25 % of reading	50 A / 10 A	
	20.000 ... 199.999 mΩ	1 μΩ	±0.25 % of reading	1 / 10 A	
	0.20000 ... 1.99999 Ω	10 μΩ	±0.25 % of reading	1 A / 100 mA	
	2.0000 ... 19.9999 Ω	100 μΩ	±0.25 % of reading	100 mA	
Function	Resistance range	Voltage range	Resolution	Accuracy	Current
Voltage	200 μΩ	1.000 mV ... 20.000 mV	1 μV	±0.25 % of reading	100 A
	2 mΩ	20.00 mV ... 200.00 mV	10 μV	±0.25 % of reading	100 A
		10.00 mV ... 100.00 mV	10 μV	±0.25 % of reading	50 A
	20 mΩ	100.0 mV ... 1.0000 V	0.1 mV	±0.25 % of reading	50 A
		20.0 mV ... 200.0 mV	0.1 mV	±0.25 % of reading	10 A
	200 mΩ	200.0 mV ... 2.0000 V	0.1 mV	±0.25 % of reading	1 A
		20.0 mV ... 200.0 mV	0.1 mV	±0.25 % of reading	10 A
	2 Ω	200.0 mV ... 2.0000 V	0.1 mV	±0.25 % of reading	1 A
		20.0 mV ... 200.0 mV	0.1 mV	±0.25 % of reading	100 mA
	20 Ω	200.0 mV ... 2.0000 V	0.1 mV	±0.25 % of reading	100 mA
Power supply	230 / 115 V _{AC}				
Battery	12 V _{DC} / 12 Ah				
Overvoltage category	CAT IV / 50 V				
Display	320 x 240 LCD with backlight				
Communications	RS 232 and USB				
Memory	512 kB (1000 test results)				
Dimensions	410 x 175 x 370 mm				
Weight	11.8 kg				

STANDARD SET:

- Instrument MicroOhm 100A
- Current test lead with crocodile clip, 5 m, 25 mm², 2 pcs
- Potential test lead, 5 m, 2 pcs (red, black)
- Test probe, 2 pcs (red, black)
- Crocodile clip, 2 pcs (red, black)
- Mains cable
- RS232 cable
- USB cable
- Bag for accessories
- PC SW HVLink PRO
- Instruction manual
- Calibration certificate



MI 3250 MicroOhm 10A

The MI 3250 MicroOhm 2A is portable low resistance ohmmeter for measuring low resistances of breakers and switches, busbars, cable joints, small to medium sized transformer and motor windings for industrial application, etc., with test current up to 10 A. The used 4-lead Kelvin testing method together with automatic bidirectional procedure ensure very high accuracy of test results (0,25%). The instrument can be powered by mains or internal rechargeable batteries. Test results can be stored on the instrument and with PC software HVLink PRO that is supplied as a part of standard set enables transfer of measured results to PC where they can be analyzed or printed.

MEASURING FUNCTIONS:

- Bidirectional resistance measurement from 0,1 $\mu\Omega$ up to 2000 Ω with test current up to 10 A;
- Temperature compensation (with optional temperature probe).

KEY FEATURES:

- **Accurate:** 0.1 n Ω best resolution with 0.25% accuracy.
- **Bar graph:** on screen resistance bar graph.
- **Battery powered:** more than 1000 measurements with 10 A test current can be performed when powered by internal battery only.
- **Safe:** High overvoltage category CAT IV / 300 V.
- **Four measuring modes:** Automatic, single, continuous and inductive
- **Automatic thermal EMF elimination:** with automatic bidirectional measurement .
- **Temperature compensation:** measured resistance can be adjusted according to ambient temperature, which can be entered manually or measured by external probe
- **Custom limits:** limits can be set for PASS/FAIL evaluation of test results.
- **Portable:** lightweight 3 kg design with carry handle and shoulder strap.
- **Memory:** built-in memory enables storage of up to 1000 test results.
- **Downloadable:** stored test results can be via RS232 or USB interface transferred to the PC with installed HVLink PRO software, which enables downloading, review, analyses and printing of the test results.



APPLICATION:

Measurement the resistance of:

- Bus bar joints
- Motor and transformer windings
- Cables
- Fuses
- Aircraft frame bonds
- Rail and pipe bonds
- Lightning conductor bonding

STANDARDS:

Electromagnetic compatibility:

IEC 61326-1

Safety:

EN 61010-1;
EN 61010-031

TECHNICAL SPECIFICATION:

Function	Measuring range	Resolution	Accuracy	Current
Resistance	1.9999 m Ω	0.1 $\mu\Omega$	$\pm(0.25\% \text{ of reading} + 0.01\% \text{ FS})$	10 A
	19.999 m Ω	1 $\mu\Omega$	$\pm(0.25\% \text{ of reading} + 0.01\% \text{ FS})$	10 A/1 A
	199.99 m Ω	10 $\mu\Omega$	$\pm(0.25\% \text{ of reading} + 0.01\% \text{ FS})$	10 A/1 A/100 mA
	1.9999 Ω	100 $\mu\Omega$	$\pm(0.25\% \text{ of reading} + 0.01\% \text{ FS})$	1 A/100 mA/10 mA
	19.999 Ω	1 m Ω	$\pm(0.25\% \text{ of reading} + 0.01\% \text{ FS})$	100 mA/10 mA
	19.999 Ω	10 m Ω	$\pm(1\% \text{ of reading} + 0.1\% \text{ FS})$	1 mA
	199.99 Ω	10 m Ω	$\pm(0.25\% \text{ of reading} + 0.01\% \text{ FS})$	10 mA
	199.99 Ω	100 m Ω	$\pm(1\% \text{ of reading} + 0.25\% \text{ FS})$	1 mA
1.9999 k Ω	1 Ω	$\pm(1\% \text{ of reading} + 0.25\% \text{ FS})$	1 mA	
Power supply (mains voltage)	90 ... 260 VAC / 60 VA			
Power supply (batteries)	6 x 1.2 V NiMH 3500 mAh batteries, type C			
Operation	> 1000 single measurements			
Overvoltage category	CAT IV / 300 V			
Protection class	Double insulation			
Display	320 x 240 LCD with backlight			
Communication	RS232 and USB			
Memory	1000 memory locations			
Dimensions	310 x 130 x 250 mm			
Weight	2.8 kg			

STANDARD SET:

- Instrument MI 3250
- Test cable, 2 m, with Kelvin Clip, 2 pcs
- Test cable, 2 m, 4 pcs (2 x black, 2 x red)
- Crocodile clip, 4 pcs (2 x black, 2 x red)
- Test probe, 2 pcs (red, black)
- Mains cable
- USB cable and RS232 cable
- NiMH rechargeable batteries, type C, 6 pcs
- PC SW HVLink PRO
- Bag for accessories
- Instruction manual
- Calibration certificate



KEY FEATURES



Fast and simple adjustment of the test parameters



Large analogue / digital LCD with backlight



Test lead connection terminal with four banana safety sockets.

MI 3242 MicroOhm 2A

MI 3242 MicroOhm 2A is a portable low resistance ohmmeter used to measure low resistances of switches, relays, connectors, bus bars, power distribution cable joints, motor & generator winding, power transformers, power inductors, rail track joints, wire and cable resistance, welding joints for industrial application, etc., with test current up to 2A

MEASURING FUNCTIONS:

- Bidirectional resistance measurement from 1 $\mu\Omega$ up to 199,9 Ω with test current up to 2 A.

KEY FEATURES:

- **Four measuring modes:** Automatic, single, continuous and inductive
- **Automatic thermal EMF elimination:** with automatic bidirectional measurement.
- **Accurate:** 1 $\mu\Omega$ best resolution with 0.25% accuracy.
- **Noise rejection:** 50 Hz / 60 Hz ripple detection and rejection.
- **Battery powered:** more than 800 measurements of 500 m Ω load @ 2 A test current & 15 s measurement duration.
- **Safe:** High overvoltage protection (CAT III / 600 V) allows measurement in substations and other points with low line resistance. Internal protection circuit protects user and instrument from inadvertent connection to lines.
- **Custom limits:** Pre-programmed limits with PASS/FAIL evaluation of measurement result and bright REEN/RED indicators providing visual evaluation of the results.
- **Portable:** Lightweight portable design.
- **Memory:** Up to 1500 test results with timestamp can be stored in internal memory.
- **Downloadable:** PC SW HVLink PRO enables downloading, review, analyses and printing of test results.



APPLICATION:

- Measurement the resistance of:**
- In inductive mode:
 - Motor & generator winding
 - Power transformer
 - Power inductors
 - Wire & cable resistance

In resistance mode:

- Relays
- Switches
- Connectors

- Busbars
- Power distributor

STANDARDS:

Electromagnetic compatibility:
EN 61326 Class A

Safety:

EN 61010-1
EN 61010-031
EN 61010-2-30

TECHNICAL SPECIFICATION:

Function	Measuring range	Resolution	Accuracy	Current
Resistance	9.999 m Ω	1 $\mu\Omega$	$\pm(0.25\% \text{ of reading} + 2 \text{ digits})$	2 A
	99.99 m Ω	10 $\mu\Omega$		
	999.9 m Ω	100 $\mu\Omega$		
	99.99 m Ω	10 $\mu\Omega$		
	999.9 m Ω	100 $\mu\Omega$		
	100 mA	9.999 Ω		1 m Ω
		19.99 Ω		10 m Ω
		999.9 m Ω		100 $\mu\Omega$
		9.999 Ω		1 m Ω
		99.99 Ω		10 m Ω
10 mA	199.9 Ω	100 m Ω		
Voltage	0 ÷ 49.9 50 ÷ 550	0.1 V 1 V	$\pm(2\% \text{ of reading} + 2 \text{ digits})$	
Frequency	10.0 ÷ 99.9 100 ÷ 500	0.1 Hz 1 Hz	$\pm(0.2\% \text{ of reading} + 1 \text{ digit})$	
Power supply (batteries)	9 VDC (6 x 1.5 V battery or accu, size AA)			
Operation	> 800 single measurements			
Overvoltage category	CAT III / 600 V; CAT IV / 300 V			
Protection class	Double insulation			
Display	128 x 64 dots matrix display with backlight			
Communication	RS232 and USB			
Memory	1500 memory locations			
Dimensions	140 x 80 x 230 mm			
Weight	0.8 kg			

STANDARD SET:

- Instrument MI 3242 MicroOhm 2A
- Test cable 4 wire, 2.5 m
- Crocodile clip, 4 pcs (2x black, 2x red)
- Test probe, 2 pcs (black)
- Power supply adapter
- 1.2 V NiMH rechargeable battery, 6pcs
- RS232 serial cable
- USB cable
- Soft carrying bag
- PC SW HVLink PRO
- Instruction manual
- Calibration certificate



KEY FEATURES



Large analogue / digital LCD with backlight



Fast and simple adjustment of the test parameters



Test lead connection terminal and USB and RS232 communication ports.

MI 3210 TeraOhmXA 10 kV

MI 3210 TeraOhm XA 10 kV is a portable, battery or mains powered test instrument with excellent IP protection (IP65), intended for diagnosing of Insulation Resistance by using high DC test voltages of up to 10 kV. Because of its robustness (CAT IV protection) and high immunity to radiated RF fields it is best suited for industrial environment.

MEASURING FUNCTIONS:

- Insulation Measurement;
- Diagnostic Test (PI, DAR, DD) ;
- Step Voltage Test;
- Withstanding Voltage Test (DC) up to 10 kV;
- Voltage and frequency measurement up to 550 V TRMS.

KEY FEATURES:

- Insulation resistance up to 20 TΩ;
- Adjustable test voltage (50 V...10 kV) 50 V and 100 V step;
- Programmable timer;
- Capacitance measurement;
- Charging rate for capacitive load < 3 s / μF at 10 kV;
- Automatic discharge of test object after completion of measurement;
- Guard terminal
- High voltage breakdown detection;
- Custom defined tests
- Auto adjustment function
- Measurement results in numerical and graphical form;
- PC software HVLink PRO for downloading and analyzing of the test results and test report printing;
- Isolated RS232 and USB communication ports, BT interface;
- High quality accessories including shielded test leads in standard set;
- High EM interferences protection: Input AC current noise rejection (1 mA@600 V) and additional averaging of the result (5, 10, 30, 60);
- CAT IV / 600 V;
- Mains and rechargeable battery power supply.



APPLICATION:

- Power transformers;
- Measuring transducers in distribution networks;
- Testing insulation resistance of rotating machinery and cables;
- Production line periodic testing and maintenance;
- Troubleshooting and analysis of all kinds of insulation problems;
- High voltage generators;
- Surge arrestors.

STANDARDS:

Electromagnetic compatibility:

EN 61326 class A

Safety:

EN 61010-1 (instrument)
 EN 61010-2-030
 EN 61010-2-033
 EN 61010-031(accessories)

TECHNICAL SPECIFICATION:

Function	Measuring range	Resolution	Accuracy
Insulation resistance	0.01 MΩ ... 9.99 MΩ	10 kΩ	±(5% of reading + 3 digits)
	10.0 MΩ ... 99.9 MΩ	100 kΩ	±(5% of reading + 3 digits)
	100 MΩ ... 999 MΩ	1 MΩ	±(5% of reading + 3 digits)
	1.00 GΩ ... 9.99 GΩ	10 MΩ	±(5% of reading + 3 digits)
	10.0 GΩ ... 99.9 GΩ	100 MΩ	±(5% of reading + 3 digits)
	100 GΩ ... 999 GΩ	1 GΩ	±(5% of reading + 3 digits)
	1.0 TΩ ... 9.9 TΩ	100 GΩ	±(5% of reading + 3 digits)
	10 TΩ ... 20 TΩ	1 TΩ	±(15% of reading + 3 digits)
Test voltage	0 V ... 999 V	1 V	±(5% of reading + 3 digits)
	1.00 kV... 9.99 kV	10 V	
	10.0 kV ... 14.0 kV	100 kV	
Insulation leakage current	1.00 mA ... 5.00 mA	10 μA	±(5% of reading + 3 digits)
	100 μA ... 999 μA	1 μA	
	10.0 μA ... 99.9 μA	100 nA	
	1.00 μA ... 9.99 μA	10 nA	
	100 nA ... 999 nA	1 nA	±(10% of reading + 0.15 nA)
	10.0 nA ... 99.9 nA	100 pA	
	0.00 nA ... 9.99 nA	10 pA	
Dielectric absorption ratio (DAR)	0.01 ... 9.99	0.01	±(5% of reading + 2 digits)
	10.0 ... 100.0	0.1	
Polarization index (PI)	0.01 ... 9.99	0.01	±(5% of reading + 2 digits)
	10.0 ... 100.0	0.1	
Dielectric discharge (DD)	0.01 ... 9.99	0.01	±(5% of reading + 2 digits)
	10.0 ... 100.0	0.1	
Voltage AC/DC	5.0 V ... 99.9 V	0.1 V	±(2% of reading + 2 digits)
	100 V ... 550 V	1 V	
Frequency	10 Hz ... 500 Hz	0.1 Hz	±(0.2% of reading + 1 digits)
Capacitance	20.0 nF ... 999 nF	1 nF	±(5% of reading + 2 digits)
	1.00 μF ... 9.99 μF	10 nF	
	10.0 μF ... 50.0 μF	100 nF	
Power supply	12 V DC (3.4 Ah Lead – Acid)		
Display	320 x 240 dots matrix display with backlight		
Overvoltage category	CAT IV / 600 V		
Protection class	Double insulation		
COM port	RS232, USB and Bluetooth		
Dimensions	345 x 160 x 335 mm		
Weight	6.5 kg		

STANDARD SET:

- Instrument MI 3210 TeraOhmXA 10 kV
- 10 kV shielded test lead with probe, 2 m
- 10 kV shielded test lead, 2 m, 2 pcs (black, red)
- 10 kV crocodile clip, 2 pcs (black, red)
- Guard test lead, green, 2 m
- Crocodile clip, green
- Mains cable
- PC SW HVLink PRO with USB and RS 232 cable
- Handbook "Guide to modern insulation testing" on CD
- Instruction manual on CD
- Calibration certificate



MI 3200 TeraOhm 10 kV

The new insulation tester MI 3202 TeraOhm 10 kV is a portable instrument intended to measure insulation resistance by using high DC test voltages up to 10 kV. TeraOhm 10 kV enables insulation resistance measurements up to 10 TΩ, step voltage test, withstanding voltage test, PI, DD and DAR calculation and capacitance measurement. The large LCD screen enables real-time graph R(t) to be displayed. Results can be stored and downloaded to a computer via USB or RS232 connection with the help of the optional HVLink PRO software. The high quality instrument, shielded test leads and quality accessories included in the standard set enable to perform insulation testing quickly and effectively.

MEASURING FUNCTIONS:

- Insulation resistance measurement;
- Step voltage insulation resistance testing;
- Withstanding voltage testing;
- Diagnostic test (PI, DD, DAR);
- R(t) graph plotting;
- Capacitance measurement;
- Voltage measurement;
- Frequency measurement.

KEY FEATURES:

- **Measuring range** up to 10 TΩ.
- **Wide range of DC test voltages:** from 500 V up to 10000 V in steps of 25 V.
- **Withstanding voltage:** testing of insulation with programmable ramp test voltage from 500 V up to 10 kV and programmable threshold current.
- **Step voltage:** insulation resistance measurement with five discrete proportionately set test voltages and programmable timer per step.
- **Automated testing:** PI, DD, DAR calculations with automated resistance ranging. All data is displayed during one single measurement.
- **Guard test terminal:** for elimination of potential surface leakage currents.
- **Fault finding:** fully programmable step voltage and withstanding voltage test functions assist in diagnosing faults in insulation.
- **Graph R(t):** real time resistance against time graph plotting facility to graphically illustrate the response of a material to an applied test voltage.
- **Built-in timer:** programmable timer from 1 s up to 100 min.
- **Automatic discharge** of tested object after test.
- **Fast testing:** 5 mA current source for quick charging of capacitive load.
- **Accurate:** selectable noise rejection filters and shielded test leads included in a standard set ensure accurate measurement.



- **Safe:** high CAT IV / 600 V voltage protection.
- **Built-in charger & rechargeable batteries:** instrument has a built-in charger and comes complete with a set of rechargeable NiMH batteries.
- **Portable:** lightweight 5.5 kg design with carry handle.

APPLICATION:

- Testing insulation resistance of rotating machinery, cables, transformers, HV generators, surge arresters;
- Production line periodic testing and maintenance;

- Troubleshooting and analysis of all kinds of insulation problems;
- Effective measurements in high noise environments such as high voltage substations and switchyards;
- Diagnostic testing.

STANDARDS:

Functionality:
IEC/EN 61557-2
Electromagnetic compatibility:
EN 61326 class B
Safety:
EN 61010-1;
EN 61010-031

TECHNICAL SPECIFICATION:

Function	Measuring range	Resolution	Accuracy
Insulation resistance	5 kΩ ... 999 kΩ	1 kΩ	±(5 % of reading + 3 digits)
	1.00 MΩ ... 9.99 MΩ	10 kΩ	±(5 % of reading + 3 digits)
	10.0 MΩ ... 99.9 MΩ	100 kΩ	±(5 % of reading + 3 digits)
	100 MΩ ... 999 MΩ	1 MΩ	±(5 % of reading + 3 digits)
	1.00 GΩ ... 9.99 GΩ	10 MΩ	±(5 % of reading + 3 digits)
	10.0 GΩ ... 99.9 GΩ	100 MΩ	±(5 % of reading + 3 digits)
	100 GΩ ... 999 GΩ	1 GΩ	±(5 % of reading + 3 digits)
Test voltage	0 V ... 9999 V	1 V	±(3 % of reading + 3 V)
	≥ 10 kV	0.1 kV	±3 % of reading
Insulation leakage current	0.00 nA ... 9.99 nA	0.01 nA	±(5% of reading + 0.05 nA)
	10.0 nA ... 99.9 nA	0.1 nA	
	100 nA ... 999 nA	1 nA	
	1.00 μA ... 9.99 μA	10 nA	
	10.0 μA ... 99.9 μA	100 nA	
	100 μA ... 999 μA	1 μA	
Dielectric absorption ratio (DAR)	0.01 ... 9.99	0.01	±(5 % of reading + 2 digits)
	10.0 ... 100.0	0.1	±5 % of reading
Polarization index (PI)	0.01 ... 9.99	0.01	±(5 % of reading + 2 digits)
	10.0 ... 100.0	0.1	±5 % of reading
Dielectric discharge (DD)	0.01 ... 9.99	0.01	±(5 % of reading + 2 digits)
	10.0 ... 100.0	0.1	±5 % of reading
Voltage AC/DC	0 V ... 600 V	1 V	±(3 % of reading + 4 V)
Frequency	45.0 Hz ... 65.0 Hz	0.1 Hz	±0.2 Hz
Capacitance	0.0 nF ... 99.9 nF	0.1 nF	±(5 % of reading + 2 digits)
	100 nF ... 999 nF	1 nF	
	1.00 μF ... 50.00 μF	10 nF	
Power supply	6 x 1.2 V NiMH rechargeable batteries, type D		
Display	Matrix LCD with backlight, 160 x 116 dots		
Overvoltage category	CAT IV / 600 V		
Protection class	Double insulation		
COM port	RS232 and USB		
Dimensions	345 x 160 x 335 mm		
Weight	5.5 kg		

STANDARD SET:

- Instrument TeraOhm 10 kV
- Mains cable
- 10 kV shielded test lead with tip, 2 m
- 10 kV shielded test lead black, 2 m
- 10 kV shielded test lead red, 2 m
- 10 kV crocodile clip, 2 pcs (black, red)
- Guard lead, green, 2 m
- Crocodile clip, green
- 6 x 1.2 V NiMH rechargeable batteries, type D
- Instruction manual
- Handbook on CD
- Calibration certificate



MI 3201 TeraOhm 5 kV Plus

The new insulation tester MI 3201 TeraOhm 5 kV Plus is a portable instrument intended to measure insulation resistance by using high DC test voltages up to 5 kV. TeraOhm 5 kV Plus enables insulation resistance measurements up to 10 TΩ, step voltage test, withstanding voltage test, PI, DD and DAR calculation and capacitance measurement. The large LCD screen enables real-time graph R(t) to be displayed. Results can be stored and downloaded to a computer via USB or RS232 connection with the help of the optional HVLink PRO software. The high quality instrument, shielded test leads and quality accessories included in the standard set enable to perform insulation testing quickly and effectively.

MEASURING FUNCTIONS:

- Insulation resistance measurement;
- Step voltage insulation resistance testing;
- Withstanding voltage testing;
- Diagnostic test (PI, DD, DAR);
- R(t) graph plotting;
- Capacitance measurement;
- Voltage measurement;
- Frequency measurement.

KEY FEATURES:

- **Measuring range** up to 10 TΩ.
- **Wide range of DC test voltages:** from 250 V up to 5000 V in steps of 25 V.
- **Withstanding voltage:** testing of insulation with programmable ramp test voltage from 250 V up to 5 kV and programmable threshold current.
- **Step voltage:** insulation resistance measurement with five discrete proportionately set test voltages and programmable timer per step.
- **Automated testing:** PI, DD, DAR calculations with automated resistance ranging. All data is displayed during one single measurement.
- **Guard test terminal:** for elimination of potential surface leakage currents.
- **Fault finding:** fully programmable step voltage and withstanding voltage test functions assist in diagnosing faults in insulation.
- **Graph R(t):** real time resistance against time graph plotting facility to graphically illustrate the response of a material to an applied test voltage.
- **Built-in timer:** programmable timer from 1 s up to 10+0 min.
- **Automatic discharge** of tested object after test.
- **Fast testing:** 5 mA current source for quick charging of capacitive load.
- **Accurate:** selectable noise rejection filters and shielded test leads included in a standard set ensure accurate measurement.



- **Safe:** high CAT IV / 600 V voltage protection.
- **Built-in charger & rechargeable batteries:** instrument has a built-in charger and comes complete with a set of rechargeable NiMH batteries.
- **Portable:** lightweight 3 kg design with carry handle and shoulder strap.

APPLICATION:

- Testing insulation resistance of rotating machinery, cables, transformers, HV generators, surge arresters;

- Production line periodic testing and maintenance;
- Troubleshooting and analysis of all kinds of insulation problems;
- Diagnostic testing.

STANDARDS:

Functionality:
IEC/EN 61557-2
Electromagnetic compatibility:
EN 61326 class B
Safety:
EN 61010-1; EN 61010-031

TECHNICAL SPECIFICATION:

Function	Measuring range	Resolution	Accuracy
Insulation resistance	5 kΩ ... 999 kΩ	1 kΩ	±(5 % of reading + 3 digits)
	1.00 MΩ ... 9.99 MΩ	10 kΩ	±(5 % of reading + 3 digits)
	10.0 MΩ ... 99.9 MΩ	100 kΩ	±(5 % of reading + 3 digits)
	100 MΩ ... 999 MΩ	1 MΩ	±(5 % of reading + 3 digits)
	1.00 GΩ ... 9.99 GΩ	10 MΩ	±(5 % of reading + 3 digits)
	10.0 GΩ ... 99.9 GΩ	100 MΩ	±(5 % of reading + 3 digits)
	100 GΩ ... 999 GΩ	1 GΩ	±(5 % of reading + 3 digits)
	1.00 TΩ ... 10.00 TΩ	10 GΩ	±(15 % of reading + 3 digits)
Test voltage	0 V ... 5500 V	1 V	±(3 % of reading + 3 V)
Insulation leakage current	0.00 nA ... 9.99 nA	0.01 nA	±(5 % of reading + 0.05 nA)
	10.0 nA ... 99.9 nA	0.1 nA	
	100 nA ... 999 nA	1 nA	
	1.00 μA ... 9.99 μA	10 nA	
	10.0 μA ... 99.9 μA	100 nA	
	100 μA ... 999 μA	1 μA	
Dielectric absorption ratio (DAR)	0.01 ... 9.99	0.01	±(5 % of reading + 2 digits)
	10.0 ... 100.0	0.1	±5 % of reading
Polarization index (PI)	0.01 ... 9.99	0.01	±(5 % of reading + 2 digits)
	10.0 ... 100.0	0.1	±5 % of reading
Dielectric discharge (DD)	0.01 ... 9.99	0.01	±(5 % of reading + 2 digits)
	10.0 ... 100.0	0.1	±5 % of reading
Voltage AC / DC	0 V ... 600 V	1 V	±(3 % of reading + 4 V)
Frequency	45.0 Hz ... 65.0 Hz	0.1 Hz	±0.2 Hz
Capacitance	0.0 nF ... 99.9 nF	0.1 nF	±(5 % of reading + 4 nF)
	100 nF ... 999 nF	1 nF	
	1.00 μF ... 50.00 μF	10 nF	
Power supply	6 × 1.2 V NiMH rechargeable batteries, type C		
Display	Matrix LCD with backlight, 160 x 116 dots		
Overvoltage category	CAT IV / 600 V		
Protection class	Double insulation		
COM port	RS232 and USB		
Dimensions	310 x 130 x 250 mm		
Weight	3 kg		

STANDARD SET:

- Instrument TeraOhm 5 kV Plus
- Small soft carrying bag
- Mains cable
- 10 kV shielded test lead with probe, black, 2 m
- 10 kV shielded test lead with probe, red, 2 m
- 10 kV crocodile clip, 2 pcs (black, red)
- Guard lead, green, 2 m
- Crocodile clip, green
- 6 x 1.2 V NiMH rechargeable batteries, type C
- Handbook on CD
- Instruction manual
- Calibration certificate



MI 2077 TeraOhm 5 kV

The MI 2077 TeraOhm 5 kV is an advanced, field proven high voltage diagnostic insulation tester. Its small lightweight design make it easily portable and its bright LCD display ensures that readings can be made in almost any lighting conditions. TeraOhm 5 kV enables insulation resistance measurements up to 5 TΩ, step voltage test, withstanding voltage test, PI, DD and DAR calculation and capacitance measurement. Built-in memory and optional PC SW TeraLink enables data storing, downloading to PC, analysis of test results and printout of test reports.

MEASURING FUNCTIONS:

- Insulation resistance measurement;
- Step voltage insulation resistance testing;
- Withstanding voltage testing;
- Diagnostic test (PI, DD, DAR);
- Capacitance measurement;
- Voltage measurement;
- Frequency measurement.

KEY FEATURES:

- **Measuring range** up to 5 TΩ.
- **Wide range of DC test voltages:** from 250 V up to 5000 V in steps of 50 V.
- **Withstanding voltage:** testing of insulation with programmable ramp test voltage from 250 V up to 5 kV and programmable threshold current.
- **Step voltage:** insulation resistance measurement with five discrete proportionately set test voltages and programmable timer per step.
- **Automated testing:** PI, DD, DAR calculations with automated resistance ranging. All data is displayed during one single measurement.
- **Fault finding:** fully programmable step voltage and withstanding voltage test functions assist in diagnosing faults in insulation.
- **Guard test terminal:** for elimination of potential surface leakage currents.
- **Automatic discharge** of tested object after test.
- **Accurate:** selectable noise rejection filters ensure accurate measurement.
- **Built-in timer:** programmable timer from 1 s up to 30 min.
- **Memory:** stores up to 1000 results with date and time stamp.
- **Easy to read:** large custom LCD dot matrix display with bar graph and with backlight.
- **Built-in charger:** instrument has a built-in charger which enables measurement during the charging.
- **Portable:** lightweight 2.1 kg design with carrying bag and neck strap.



APPLICATION:

- Testing insulation resistance of rotating machinery, cables, transformers, HV generators, surge arresters;
- Production line periodic testing and maintenance;
- Troubleshooting and analysis of all kinds of insulation problems;
- Diagnostic testing.

STANDARD SET:

- Instrument TeraOhm 5 kV
- Soft carrying bag
- Mains cable
- Test lead, black, 2 m
- Test lead, red, 2 m
- Guard lead, green, with crocodile clip, 2 m
- Test probe, black
- Test probe, red
- Crocodile clip, black, 2 pcs
- Handbook on CD
- Instruction manual
- Calibration certificate

STANDARDS:

- **Functionality:** IEC/EN 61557-2
- **Electromagnetic compatibility:** EN 61326 Class B
- **Safety:** EN 61010-1; EN 61010-031



TECHNICAL SPECIFICATION:

Function	Measuring range	Resolution	Accuracy
Insulation resistance	0 kΩ ... 999 kΩ	1 kΩ	±(5 % of reading + 3 digits)
	1.00 MΩ ... 9.99 MΩ	10 kΩ	±(5 % of reading + 3 digits)
	10.0 MΩ ... 99.9 MΩ	100 kΩ	±(5 % of reading + 3 digits)
	100 MΩ ... 999 MΩ	1 MΩ	±(5 % of reading + 3 digits)
	1.00 GΩ ... 9.99 GΩ	10 MΩ	±(5 % of reading + 3 digits)
	10.0 GΩ ... 99.9 GΩ	100 MΩ	±(5 % of reading + 3 digits)
	100 GΩ ... 999 GΩ	1 GΩ	±(5 % of reading + 3 digits)
1.00 TΩ ... 5.00 TΩ	10 GΩ	±(5 % of reading + 3 digits)	
Test voltage	0 V ... 5500 V	1 V	±(3 % of reading + 3 V)
Insulation leakage current	0.00 nA ... 9.99 nA	0.01 nA	±(5 % of reading + 0.05 nA)
	10.0 nA ... 99.9 nA	0.1 nA	
	100 nA ... 999 nA	1 nA	
	1.00 μA ... 9.99 μA	10 nA	
	10.0 μA ... 99.9 μA	100 nA	
	100 μA ... 999 μA	1 μA	
Dielectric absorption ratio (DAR)	0.01 ... 9.99	0.01	±(5 % of reading + 2 digits)
	10.0 ... 100.0	0.1	±5 % of reading
Polarization index (PI)	0.01 ... 9.99	0.01	±(5 % of reading + 2 digits)
	10.0 ... 100.0	0.1	±5 % of reading
Dielectric discharge (DD)	0.01 ... 9.99	0.01	±(5 % of reading + 2 digits)
	10.0 ... 100.0	0.1	±5 % of reading
Voltage AC / DC	0 V ... 600 V	1 V	±(3 % of reading + 3 V)
Frequency	45.0 Hz ... 65.0 Hz	0.1 Hz	±0.2 Hz
Capacitance	0.0 nF ... 99.9 nF	0.1 nF	±(5 % of reading + 2 digits)
	100 nF ... 999 nF	1 nF	
	1.00 μF ... 50.00 μF	10 nF	
Battery power supply	6 x 1.2 V NiMH rechargeable batteries, type C		
Display	Matrix LCD with backlight, 160 x 116 dots		
Overvoltage category	CAT III / 600 V		
Protection class	Double insulation		
COM port	RS232 (optional USB with serial converter)		
Dimensions	265 x 110 x 185 mm		
Weight	2.1 kg		

KEY FEATURES



Large custom LCD dot matrix display with bar graph and backlight.



User friendly keyboard enables simple and fast adjustment.



Guard connection terminal to eliminate the influence of surface insulation currents.

MI 3202 GigaOhm 5 kV

The MI 3202 GigaOhm 5 kV provides quick and accurate testing of insulation resistance. Five test voltages up to 5 kV and 1 TΩ resistance measuring range cover most of the industrial and power distribution applications. The large analogue / digital LCD screen with backlight offers easy reading of test results. The instrument is placed in a rugged carrying case which allows to use it in harsh environments.

MEASURING FUNCTIONS:

- Insulation resistance measurement;
- Voltage measurement;
- Frequency measurement.

KEY FEATURES:

- **Measuring range** up to 1 TΩ.
- **Analogue scale and digital LCD:** measuring results are displayed both in numeric and analogue form.
- **Quick set-up:** quick and easy selection of test voltage (250 V; 500 V; 1 kV; 2,5 kV; 5 kV).
- **Fast testing:** 5 mA current source for quick charging of capacitive load.
- **Guard test terminal:** for elimination of potential surface leakage currents.
- **Automatic discharge** of tested object after test.
- **Safe:** high CAT IV / 600 V voltage protection.
- **Easy to read:** large bright LCD with backlight.
- **Built-in charger & rechargeable batteries:** instrument has a built-in charger and comes complete with a set of rechargeable NiMH batteries.
- **High quality accessories:** shielded test leads are included in a standard set.
- **Portable:** lightweight 3 kg design with carry handle and shoulder strap.



APPLICATION:

- Testing insulation resistance of rotating machinery and cables;
- Production line periodic testing and maintenance;
- Troubleshooting and analysis of all kinds of insulation problems.

STANDARDS:

Functionality:
IEC/EN 61557-2
Electromagnetic compatibility:
EN 61326 class B
Safety: EN 61010-1; EN 61010-031

STANDARD SET:

- Instrument GigaOhm 5 kV
- Mains cable
- 10 kV shielded test lead with probe, black, 2 m
- 10 kV shielded test lead with probe, red, 2 m
- 10 kV crocodile clip, 2 pcs (black, red)
- Guard lead, green, 2 m
- Crocodile clip, green
- 6 x 1.2 V NiMH rechargeable batteries, type C
- Handbook on CD
- Instruction manual
- Calibration certificate



TECHNICAL SPECIFICATION:

Function	Measuring range	Resolution	Accuracy
Insulation resistance	5 kΩ ... 999 kΩ	1 kΩ	±(5 % of reading + 3 digits)
	1.00 MΩ ... 9.99 MΩ	10 kΩ	±(5 % of reading + 3 digits)
	10.0 MΩ ... 99.9 MΩ	100 kΩ	±(5 % of reading + 3 digits)
	100 MΩ ... 999 MΩ	1 MΩ	±(5 % of reading + 3 digits)
	1.00 GΩ ... 9.99 GΩ	10 MΩ	±(5 % of reading + 3 digits)
	10.0 GΩ ... 99.9 GΩ	100 MΩ	±(5 % of reading + 3 digits)
	100 GΩ ... 999 GΩ	1 GΩ	±(10 % of reading + 3 digits)
Test voltage	0 V ... 5500 V	1 V	±(3 % of reading + 3 V)
Voltage AC / DC	0 V ... 600 V	1 V	±(3 % of reading + 4 V)
Frequency	45.0 Hz ... 65.0 Hz	0.1 Hz	±0.2 Hz
Battery power supply	6 x 1.2 V NiMH rechargeable batteries, type C		
Display	Analogue / digital LCD with backlight		
Overvoltage category	CAT IV / 600 V		
Protection class	Double insulation		
Dimensions	310 x 130 x 250 mm		
Weight	3 kg		

KEY FEATURES



Fast and simple adjustment of the test parameters



Large analogue / digital LCD with backlight



Guard terminal for connecting shielded test leads

MI 3121H SMARTeC[®] 2,5 kV Insulation / Continuity

The MI 3121H Smartec 2,5 kV Insulation / Continuity is the portable measuring instrument for complete diagnostic testing of insulation and continuity measurements. Due to insulation resistance measurement with the test voltages up to 2.5 kV (measuring range is up to 100 GΩ) and calculation of PI and DAR indexes the instrument is suited for testing insulation of cable lines, current and voltage transformers, electric motors, etc. Due to configurable limits the instrument enables PASS / FAIL evaluation of test results which is accompanied with bright green or red light of LEDs. Additional features include magnetic holder for fixing the tester on the metal surface and built-in charger. The Mi 3121H is compatible with EuroLink PRO software which enables downloading and analysis of test results and creation of professional test reports.

MEASURING FUNCTIONS:

- Insulation resistance with DC voltage up to 2.5 kV;
- Diagnostic test (PI, DAR calculation)
- Continuity of PE conductors with 200 mA test current and polarity change;
- Continuity of PE conductors with 7 mA test current (continuous measurement) without RCD tripping;
- TRMS voltage and frequency.

KEY FEATURES:

- **High measuring range:** up to 100 GΩ with test voltage from 100 to 2500 V.
- **Insulation diagnostics:** PI and DAR calculation for determining if the insulation damaged or contaminated.
- **Guard test terminal:** for elimination of potential surface leakage currents.
- **Polarity swap:** automatic polarity reversal on continuity test.
- **Analogue scale:** measuring results are displayed in numeric and analogue representation.
- **Custom limits:** if limits are set on insulation or continuity function then large green and red lights of the LEDs will indicate a PASS or FAIL evaluation of test result.
- **Safe:** suited for testing on CAT IV installations.
- **Built-in charger & rechargeable batteries:** instrument has a built-in charging circuit and comes complete with a set of rechargeable NiMH batteries.
- **Memory:** two level memory structure for saving of test results and parameters.
- **Downloadable:** downloads via RS232 or USB cable directly to the PC with the help of the PC software EuroLink PRO.
- **Easy to use:** large bright LCD display and large buttons enable easy handling of the instrument (even while wearing gloves).
- **Magnetic holder:** magnet for fixing



instrument on metal surfaces enables hands-free operation.

APPLICATION:

- Measurement of insulation resistance of transformers, motors, cables, machines, etc;
- Testing on CAT IV installations (distribution side of installations, industrial plants, etc);
- Observation of insulation trends;
- Testing of PE conductors continuity and main and supplementary PE connections.

STANDARDS:

Functionality:
IEC/EN 61557 Parts 1, 2, 4, 10
IEC/EN 60364
VDE 100
BS 7671 17th edition
CEI 64.8

Electromagnetic compatibility:
IEC/EN 61326-1;

Safety:
IEC/EN 61010-1;
EN 61010 - 031

TECHNICAL SPECIFICATION:

Function	Measuring range	Resolution	Accuracy
Insulation resistance (EN 61557-2)	U = 500, 1000, 2500 V _{DC} : R: 0.00 MΩ ... 19.99 MΩ 20.0 MΩ ... 199.9 MΩ 200 MΩ ... 999 MΩ 1.00 GΩ ... 4.99 GΩ 5.00 GΩ ... 19.99 GΩ 20.0 GΩ ... 99.9 GΩ	0.01MΩ 0.1MΩ 1 MΩ 10 MΩ 10 MΩ 100 MΩ	±(5 % of reading + 3 digits) ±5 % of reading ±5 % of reading ±10 % of reading ±20 % of reading ±20 % of reading
	U = 100, 250 V _{DC} : R: 0.00 MΩ ... 19.99 MΩ 20.0 MΩ ... 199.9 MΩ 200 MΩ ... 999 MΩ	0.01 MΩ 0.1 MΩ 1 MΩ	±(5 % of reading + 3 digits) ±10 % of reading ±20 % of reading
PI, DAR	0.01 ... 9.99 10.0 ... 100.0	0.01 0.1	±(5 % of reading + 2 digits) ±5 % of reading
Continuity 200 mA of PE conductor with polarity change (EN 61557-4)	0.00 Ω ... 19.99 Ω 20.0 Ω ... 199.9 Ω 200 Ω ... 1999 Ω	0.01 Ω 0.1 Ω 1 Ω	±(3 % of reading + 3 digits) ±5 % of reading ±10 % of reading
	Low resistance measurement with 7 mA test current (continuous measurement)	0.0 Ω ... 19.9 Ω 20 Ω ... 1999 Ω	0.1 Ω 1 Ω
Voltage	0.0 V ... 99.9 V 100 V ... 550 V	0.1 V 1 V	±(3 % of reading + 3 digits)
	Frequency	0.00 Hz ... 19.99 Hz 20.0 Hz ... 199.9 Hz 200 Hz ... 500 Hz	0.01 Hz 0.1 Hz 1 Hz
Power supply	6 x 1.2 V rechargeable batteries, type AA		
Overvoltage category	CAT III / 600 V; CAT IV / 300 V		
Protection class	Double insulation		
COM port	RS232 and USB		
Dimensions	140 x 230 x 80 mm		
Weight	0.85 kg		

KEY FEATURES



Large LCD screen with backlight and PASS / FAIL indicators.



Simple and fast manipulation.



USB and RS232 communication ports.

STANDARD SET:

- Instrument Smartec 2,5 kV Insulation / Continuity
- Soft hand strap
- Test lead, 2 x 1.5 m
- Test probe, 2 pcs (black, red)
- Crocodile clip, 2 pcs (black, red)
- Power supply adapter + 6 NiMH rechargeable batteries, type AA
- Instruction manual on CD
- Short instruction manual
- Handbook on CD
- Calibration certificate



HVLink PRO

The HVLink PRO software works in conjunction with Metrel newest HV insulation testers, Step Contact Voltage Measuring System and MicroOhms. The software automatically recognizes connected instrument and allows the customer to download test results saved on the instrument, review the results, rename and relocate data if needed and print test reports.

KEY FEATURES:

- **Automatic recognition of the instrument:** when connecting your instrument to the PC it is automatically recognized by the software.
- **Tree view:** all the results are represented in tree view for easy data management.
- **Rearranging of structures:** the elements of the tree structure can be relocated and renamed.
- **R(t) graphs:** if graph R(t) was enabled when testing with the instrument MI 3200 or MI 3201 then it can be plotted and printed with the software.
- **Measurement tables:** if graph R(t) was enabled when testing with the instrument MI 3200 or MI 3201 then a table with fixed R(t) values can be viewed and printed.
- **Export of test results:** test results in text format can be exported to other programs (MS Excel, MS Word).
- **Automatic Test Report generation:** enables automatic generation of Test Report (low, medium and high detailed).

PC SW HVLink PRO is compatible with:

- MI 3210 TeraOhmXA 10 kV
- MI 3200 TeraOhm 10 kV
- MI 3201 TeraOhm 5 kV Plus
- MI 3295 Step Contact Voltage Measuring System
- MI 3252 MicroOhm 100A

PASSWORD PROTECTION:

PC SW HVLink PRO is password protected for the following instruments:

- MI 3200
- MI 3201

ORDERING INFORMATION:

- A 1275 PC SW HVLink PRO with USB and RS232-PS/2 cable

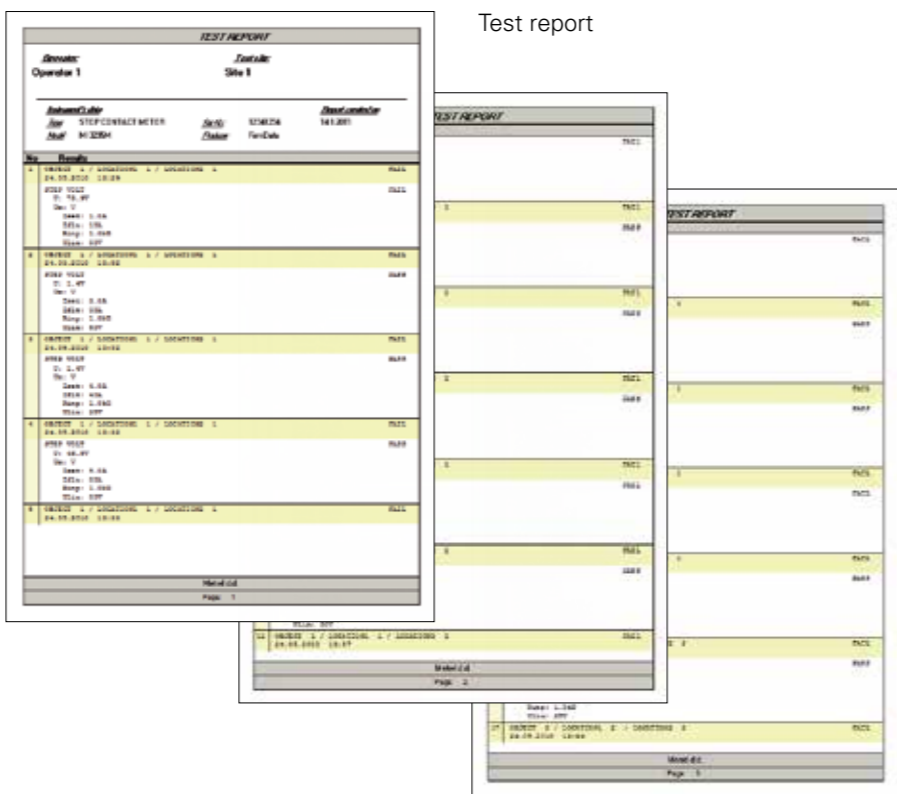
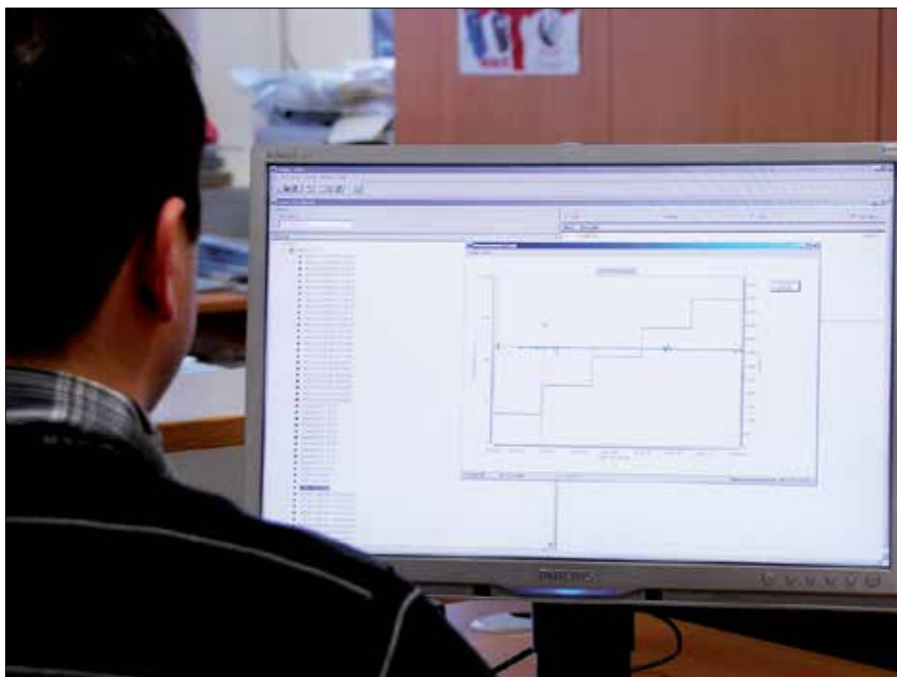

Test report

User friendly interface with tree view data structure and full, medium or low representation of test results.

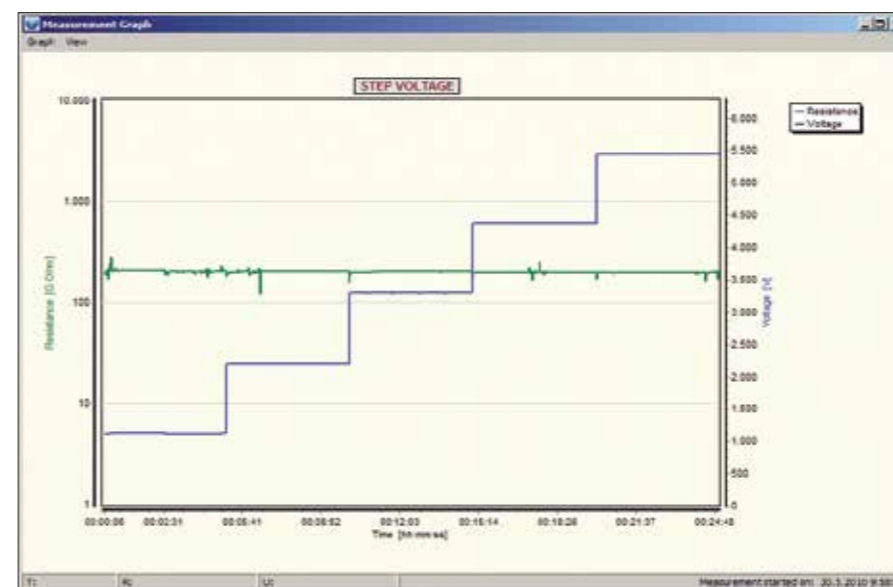
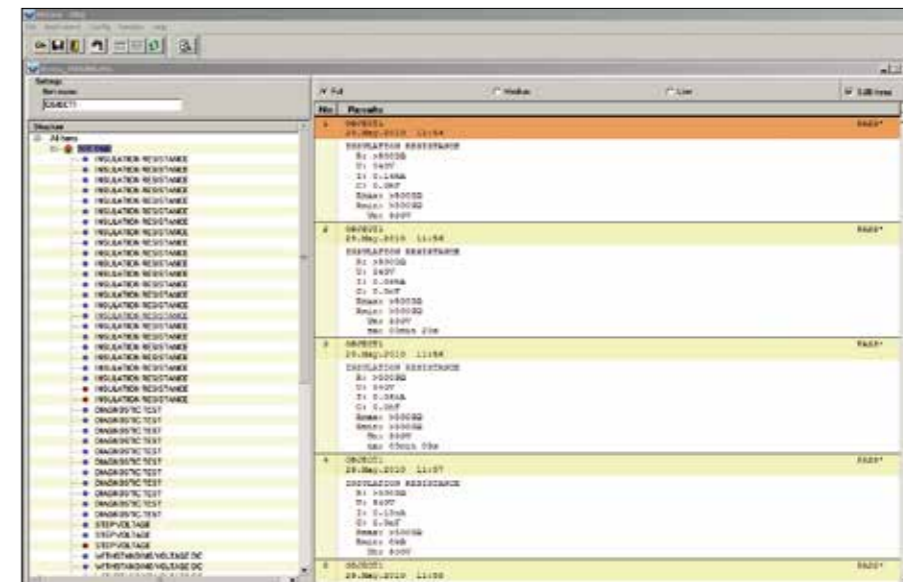
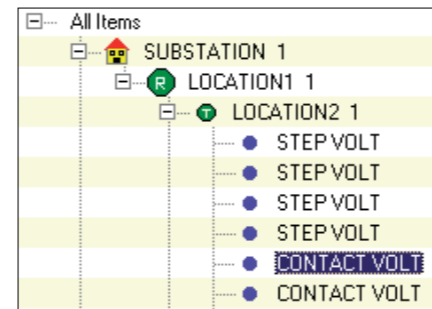

R(t) graph can be drawn for HV Insulation Resistance measuring functions.



Table with fixed R(t) values can be drawn for HV Insulation Resistance measuring functions.

No	Time (h:mm:ss)	Resistance	Voltage
1	00:00:15	> 4,85 TOhm	5,126 kV
2	00:00:33	1,1 GOhm	5,131 kV
3	00:01:00	1,02 GOhm	5,131 kV
4	00:02:00	9,88 GOhm	5,126 kV
5	00:03:00	502 GOhm	5,126 kV
6	00:04:00	506 GOhm	5,126 kV
7	00:05:00	502 GOhm	5,125 kV
8	00:06:01	19,9 MOhm	5,114 kV
9	00:07:00	1,02 GOhm	5,130 kV
10	00:08:00	2,03 GOhm	5,127 kV
11	00:09:00	49,9 MOhm	5,120 kV
12	00:10:00	50 MOhm	5,120 kV

No	Time (h:mm:ss)	Resistance	Voltage
1	00:00:15	> 4,85 TOhm	5,126 kV
2	00:00:33	1,1 GOhm	5,131 kV
3	00:01:00	1,02 GOhm	5,131 kV
4	00:02:00	9,88 GOhm	5,126 kV
5	00:03:00	502 GOhm	5,126 kV
6	00:04:00	506 GOhm	5,126 kV
7	00:05:00	502 GOhm	5,125 kV
8	00:06:01	19,9 MOhm	5,114 kV
9	00:07:00	1,02 GOhm	5,130 kV
10	00:08:00	2,03 GOhm	5,127 kV
11	00:09:00	49,9 MOhm	5,120 kV
12	00:10:00	50 MOhm	5,120 kV

MI 3299 HV demo BOX

The MI 3299 High voltage Demonstration Box 10 kV has been developed for demonstration purposes at high voltage insulation diagnostics. It simulates typical electrical insulation usually met in the industrial environment. It is equipped with high quality resistors in different ranges, high voltage capacitors and a discharge facility to simulate a breakdown phenomenon in gases. Additionally measurements of polarization index (PI), dielectric discharge (DD) and dielectric absorption ratio (DAR) can be demonstrated. Packed with all these features the demonstration box is also well suited for basic calibration of DC high voltage insulation resistance measuring instruments.

KEY FEATURES:

- 10 kV rated resistors with very low voltage coefficient.
- Resistive decade with 200 kΩ, 500 MΩ, 200 GΩ and 2 TΩ resistors.
- HV capacitors in 2.5 μF and 5 nF range.
- Built-in spark gap and gas discharge tube.
- Demonstration of insulation breakdown in gases is possible.
- Two models of insulation material (good and bad cables) enable the demonstration of real insulation behavior under high DC voltage.
- Demonstration box is put in the strong rugged case with handle for comfortable carrying.



APPLICATION:

- Demonstration of insulation diagnostics measurement with DC test voltage;
- Demonstration of functionality of HV insulation measuring instruments;
- Training centres, schools, laboratories;
- Basic calibration of DC high voltage insulation testers.

STANDARDS:

Safety:
EN 61010-1

TECHNICAL DATA:

Dimensions	440 × 320 × 110 mm
Weight	4 kg

STANDARD SET:

- HV demo BOX 10 kV
- HV test leads, 2 pcs
- Instruction manual
- Handbook on CD
- Calibration certificate



Selection Guide for HV Accessories

Photo	Part number	Description	Target application	MI 3295	MI 3252	MI 3250	MI 3242	MI 3210	MI 3200	MI 3201	MI 2077	MI 3202	MI 3121H
	MI 3295M Set	Step Contact Meter Measuring Set	Additional MI 3295M Set for simultaneous measurements of step voltage and contact voltage on different test points. Set includes instrument MI 3295M, test lead, 2 x 3 m, soft carrying bag, soft carrying neck belt, NiMH battery, type AA, 6 pcs, Power supply adapter.	✓	-	-	-	-	-	-	-	-	-
	A 1014	Test probe, black	Test probe with Ø 4 mm connection is suitable for performing measurements both in mains outlets and in situations when no schuko outlet is present.	-	-	-	-	-	-	-	-	-	✓
	A 1013	Crocodile clip, black	Crocodile clip assures secure and permanent contact during the measurement on bus bars, fixing screws, etc.	-	-	-	-	-	-	-	✓	-	✓
	A 1064	Crocodile clip, red	Crocodile clip assures secure and permanent contact during the measurement on bus bars, fixing screws, etc.	-	-	-	-	-	-	-	✓	-	-
	A 1309	Crocodile clip, green	Crocodile clip assures secure and permanent contact during the measurement on bus bars, fixing screws, etc.	-	-	-	-	-	✓	✓	✓	✓	-
	S 2036	HV crocodile clip, 2 pcs (red, black)	10 kV crocodile clips for HV insulation resistance measurement assure secure and permanent contact during the measurement on bus bars, fixing screws, etc.	-	-	-	-	✓	✓	✓	✓	✓	-
	A 1046	1.2 V NiMH battery, type C, 6 pcs	A set of 6 pieces of rechargeable batteries, type C.	-	-	-	-	-	-	✓	✓	✓	-
	S 2054	1.2 V NiMH battery, type D, 6 pcs	A set of 6 pieces of rechargeable batteries, type D.	-	-	-	-	-	✓	-	-	-	-
	A 1169	Fast charger for AA, C, D and 9 V block batteries	Fast battery charger for up to 12 pcs AA, 6 pcs C or D rechargeable batteries, 4 pcs 9 V block batteries.	✓	-	✓	✓	-	✓	✓	✓	✓	✓
	A 1017	Communication cable RS232	RS232 interface cable for connecting the instrument with the PC.	-	-	-	-	✓	✓	✓	✓	-	-
	A 1171	RS232 / USB adapter with 1 m cable	RS232 / USB adapter for instruments without USB communication port.	-	-	-	-	-	-	-	✓	-	-
	A 1056	PC SW TeraLink with RS232 cable	PC Software TeraLink supplied with RS232 interface cable supports test results downloading and creation of test reports.	-	-	-	-	-	-	-	✓	-	-

✓ Option - Not available

Selection Guide for HV Accessories

Photo	Part number	Description	Target application	MI 3295	MI 3252	MI 3250	MI 3242	MI 3210	MI 3200	MI 3201	MI 2077	MI 3202	MI 3121H
	A 1275	PC SW HVLink PRO	HVLink PRO is a downloading and data management PC software with R=f(t) graph printing functionality (for HV insulation testers). It comes delivered with RS232 and USB communication cables.	✓	✓	-	-	✓	✓	✓	-	-	-
	A 1291	PC SW EuroLink PRO with USB and RS232-PS/2 cable	PC Software EuroLink PRO enables downloading and test results management and printing of test reports. Delivered with RS232-PS/2 and USB communication cables.	-	-	-	-	-	-	-	-	-	✓
	A 1333	Resistor SHUNT, 750 μΩ	Resistor SHUNT is used for testing correctness of micro ohmmeters.	-	✓	✓	-	-	-	-	-	-	-
	A 1323	Current and potential earth spike (with 3m lead)	Auxiliary current earth spikes for decreasing the earth resistance and potential earth spike for specific earth measurements.	✓	-	-	-	-	-	-	-	-	-
	A 1353	Step voltage probe (25 kg), 2 pcs	Additional voltage probes for step voltage measurements.	✓	-	-	-	-	-	-	-	-	-
	S 2053	Step voltage plates	Light replacement for 25kg Step voltage probes A 1353.	✓	-	-	-	-	-	-	-	-	-
	S 2058	Insulation test plates	Two in one: Test plates for measurement of floor and wall insulation, Δ625 cm² (acc. to EN 60364-6) and measurement of semi conductivity, 2,5 kg, Ø65 mm (acc. to EN 61340-5-1).	-	-	-	-	-	✓	✓	✓	✓	✓
	A 1012	Test lead, green, 4 m	Extension test lead.	-	-	-	-	-	✓	✓	✓	✓	-
	A 1154	Test lead, black, 4 m	Extension test lead for earth and continuity measurements.	-	-	-	-	-	-	-	-	-	✓
	A 1319	2.5 kV test lead, 3 x 1.5 m	3-wire test lead with GUARD connection for insulation resistance measurements with test voltage up to 2,5 kV. Recommended to be used when measuring high insulation resistances (>10 GΩ).	-	-	-	-	-	-	-	-	-	✓
	A 1153	Test lead, black, 20 m	Extension test lead for earth and continuity measurements.	-	-	-	-	-	-	-	-	-	✓
	A 1383	Temperature probe with 2 m cable	Temperature probe with measuring range from -55 °C to +125 °C for measurement of ambient temperature.	-	-	✓	-	-	-	-	-	-	-

✓ Option - Not available

Selection Guide for HV Accessories

Photo	Part number	Description	Target application	MI 3295	MI 3252	MI 3250	MI 3242	MI 3210	MI 3200	MI 3201	MI 2077	MI 3202	MI 3121H
	A 1437	Test lead with Kelvin probe	Test lead with Kelvin probe for fast resistance measurements.	-	-	✓	✓	-	-	-	-	-	-
	A 1407	Test cable Kelvin 500 A, 2,5 m	Test cable with 500 A Kelvin clamps for easy and accurate resistance measurements with MI 3242.	-	-	-	✓	-	-	-	-	-	-
	A 1408	Test cable Kelvin, 2,5 m	Test cable with Kelvin clamps for easy resistance measurements with MI 3242.	-	-	-	✓	-	-	-	-	-	-
	S 1072	Continuity test lead, with crocodile clip, 2 x 2.5 m, 2 pcs	Kelvin test probes with crocodile clips and protection shield as lightweight alternative to clips within the standard set.	-	-	✓	-	-	-	-	-	-	-
	S 2046	Current test lead with insulated crocodile clip, 5 m, 25 mm², 2 pcs	100 A current test lead with insulated crocodile clip for performing accurate resistance measurements with MI 3252.	-	✓	-	-	-	-	-	-	-	-
	S 2052	Current test lead with crocodile clip, 10 m, 50 mm², 2 pcs	Extended 100 A current test leads for accurate measurements with MI 3295.	-	✓	-	-	-	-	-	-	-	-
	S 2003	5 kV test lead set, 2 m, 2 pcs	5 kV test lead set, including 2 test leads and 2 crocodile clips, for safe insulation testing.	-	-	-	-	-	-	-	✓	-	-
	S 2029	10 kV shielded test lead, 8 m, 2 pcs	10 kV shielded test leads improve accuracy of HV insulation resistance measurement in environments with high content of external electromagnetic interferences.	-	-	-	-	✓	✓	✓	-	✓	-
	S 2030	10 kV shielded test lead, 15 m, 2 pcs	10 kV shielded test leads improve accuracy of HV insulation resistance measurement in environments with high content of external electromagnetic interferences.	-	-	-	-	✓	✓	✓	-	✓	-
	S 2039	5 kV shielded test lead, 15 m, 2 pcs	5 kV shielded test leads for MI 2077 improve accuracy of HV insulation resistance measurement in environments with high content of external electromagnetic interferences.	-	-	-	-	-	-	-	✓	-	-
	S 2042	5 kV shielded test lead with test probe, 10 m, 2 pcs	Set of 5 kV shielded test leads with test probe and Guard test lead with crocodile clip for MI 2077 improves accuracy of HV insulation resistance measurement in environments with high content of external electromagnetic interferences.	-	-	-	-	-	-	-	✓	-	-
	S 2044	5 kV shielded test lead with test probe, 15 m, 2 pcs	5 kV shielded test leads with test probe improve accuracy of HV insulation resistance measurement in environments with high content of external electromagnetic interferences.	-	-	-	-	-	-	-	✓	-	-

✓ Option - Not available

Selection Guide for HV Accessories

Photo	Part number	Description	Target application	MI 3295	MI 3252	MI 3250	MI 3242	MI 3210	MI 3200	MI 3201	MI 2077	MI 3202	MI 3121H
	A 1271	Small soft carrying bag	Small soft carrying bag for transport and storage of test instrument or accessories.	-	-	-	-	-	-	✓	✓	✓	✓
	A 1006	Soft carrying bag	Large soft carrying bag for transport and storage of test instrument and belonging accessories.	-	-	-	-	-	-	-	✓	-	✓

MEASURING INSTRUMENTS AND TESTERS

- Electrical Installation Safety
- High Voltage Insulation / Continuity / Earth
- Appliance / Machine / Switchboard Safety
- Power Quality Analysis
- LAN Cabling Certification
- Indoor Environment Quality
- Digital Multimeters / Clamp Meters / Voltage and Continuity Testers
- Variable transformers / Equipment for laboratories and schools

GOOD TO KNOW

Testing the safety of electrical appliances 3 - 02

PAT TESTERS

Selection Guide for PAT testers 3 - 05

MI 3305 OmegaGT Plus and MI 3304 BetaGT Plus 3 - 06

MI 3310 25A SigmaGT and MI 3310 SigmaGT 3 - 08

MI 3309 BT DeltaGT 3 - 10

MI 3311 GammaGT 3 - 12

MI 2142 AlphaPAT 3 - 14

OTHER INSTRUMENTS / ADAPTERS / ACCESSORIES

A 1322 and A 1422 Active 3-phase Adapter 3 - 16

DEMONSTRATION BOARD

MI 3300 Portable Appliance Simulation Board 3 - 18

GOOD TO KNOW

Testing the safety of electrical appliances, machines and switchboards 3 - 20

MACHINE AND SWITCHBOARD TESTERS

Selection Guide for Machine and Switchboard testers 3 - 23

MI 2094 CE MultiTester 3 - 24

MI 3321 MultiServicerXA 3 - 26

MI 2170 MultiServicer 3 - 28

PC SOFTWARE

PATLink PRO and PATLink PRO Plus 3 - 30

A 1433 PATLink Android **NEW** 3 - 32

A 1434 aPATLink Android **NEW** 3 - 33

Selection Guide for PAT Accessories 3 - 34

Testing PAT

Find out more about testing safety of electrical equipment.

Primary goal of testing safety of electrical equipment is to use all electrical equipment without danger. Common accidents caused by electrical equipment are:

- Injuries through electric shock caused by malfunctioned equipment;
- Injuries through overheated equipment;
- Fire and explosions.

To prevent risk and possible danger caused by using electrical appliances and other equipment appropriate safety testing procedure should be performed. Testing of electrical equipment is not regulated the same way in all countries. For instance in Germany, UK, Australia testing of all electrical equipment is strictly regulated by law. Through their positive experience it can be assumed that other countries will follow in the future.

Safety of electrical equipment depends on different factors which can improve or worsen the safety level.

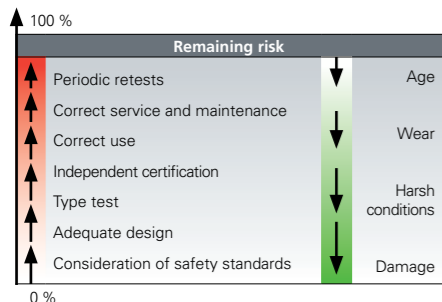

Types of safety tests of electrical equipment are:

- Type testing;
- End of line testing;
- Maintenance testing;
- Periodic testing.

According to the standards electrical equipment is divided in:

- Electrical appliances;
- Electrical equipment in medical use;
- Electrical machines;
- Electrical switchgears.

Classification of appliances by field of use:

- Laboratory equipment;
- Measuring and regulating equipment;

- Power supplies;
- Heating appliances;
- Handheld tools;
- Luminaries;
- Consumer electronic;
- Information and communication technology (computers, fax machines, scanners, etc.);
- Prolongation cords, IEC supply cords;
- Appliances for medical use.

Classification of appliances by protection classes:

According to the design electrical equipment can be divided in three classes. In the table below the differences between classes are described.

Class	I	II	III
Marking	no		
Connection to protection (PE) conductor of the installation.	yes	no	no connection to mains
Basic insulation	performed	performed	performed / looser limits
Supplementary or reinforced insulation	not needed in general, needed if there are accessible unearthed metal parts 1)	performed	not needed
Supply cord	three pole (L,N, PE)	can be two pole	two pole
Notes	installation must have adequate earthing resistance		must be supplied from a SELV (safety low voltage) source, typically 12 V or 24 V

Portable appliances - measurements: Visual check

Visual test of the equipment is intended to confirm that there are no visible signs of damage or defects. Result of visual test can be stored on most of Metrel PAT testers for future reference.

Earth bond (continuity of protective conductor) test

With the earth bond test following is determined:

- That the contacts between accessible metal parts and PE conductor are firm.
- That PE wire in the appliance supply cord is undamaged.
- That there are no signs of poor contacts, corrosion etc.

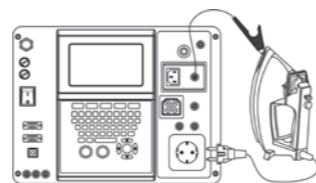

Earth bond test

Test signal is applied between PE pin of supply cord and accessible earthed metal parts.

Insulation resistance

Insulation resistance between live conductors and all accessible metal parts (earthed and isolated) is checked. This test discloses faults caused by pollution, moisture, deterioration of insulation material etc.

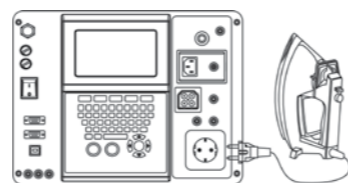

Insulation resistance test for Class I device

High DC voltage test signal is applied between connected live pins and PE contact of supply cord. Unearthed accessible metal parts are NOT included in this test and are measured as Class II items.

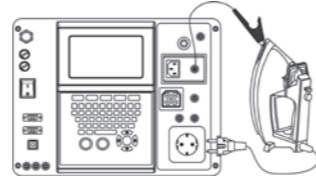

Insulation resistance test for Class II device

High DC voltage test signal is applied between connected live pins and accessible isolated metal part.

Substitute leakage test

In this test the live and neutral conductors of the appliance are shorted together and voltage of 30 - 50 V AC is applied between this point and either the earth conductor (class I) or the probe connected to any exposed conductive part (class I and class II). The test measures how much current passes from the live conductors into the test point.

Testing PAT

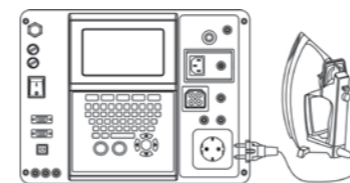

Substitute leakage test for Class I device

AC test signal is applied between connected live pins and PE contact of supply cord. Isolated accessible metal parts are NOT included in this test and are measured as Class II items.

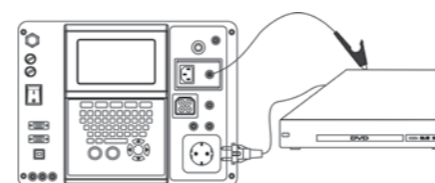

Substitute leakage test for Class II device

AC test signal is applied between connected live pins and accessible isolated metal part.

Leakage current tests

In this test the sum of leakage currents caused by appliance insulation resistances (resistive currents through the insulation material, fault currents through decreased insulation) and capacitances (capacitive leakage current) is checked. Excessive leakage currents are most often caused by deterioration of the appliance insulation (pollution, ageing, moisture) or faults in mains circuits of appliances.

In general three leakage currents are measured: the differential leakage current, the PE conductor (direct) leakage current and the touch leakage current.

PE conductor leakage test

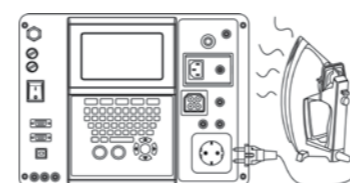

PE conductor leakage current test for Class I device

Appliance must be powered on. The current flowing through appliance PE conductor is measured. Appliance must be placed isolated against ground. Unearthed accessible metal parts are not included in this test. They are consid-

ered as class II parts and are checked in the Touch Leakage test.

Differential leakage current test

Differential leakage measures the difference in current between the live and neutral cable which provides a true value of how much current the appliance leaks to ground.

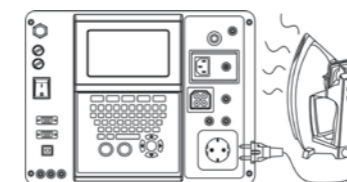

Differential leakage current test for Class I device

Appliance must be powered on. The leakage current is measured as the difference of currents through L and N conductors. Unearthed accessible metal parts are not included in this test. They are considered as class II parts and are checked in the Touch Leakage test.

Touch leakage test

Leakage leakage current is a current that would flow via the isolated accessible metal part (if touched) through body to ground are measured in this test.

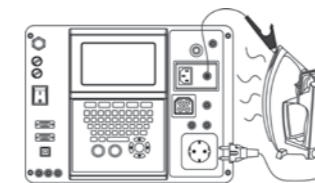

Touch leakage current test for Class II device

Appliance must be powered on. The current through the isolated accessible metal parts is measured (each part separately).

Polarity test

Polarity test checks the correctness of polarity of IEC leads, prolongation cords etc is checked. With this test shorts, crossed and opened wires in cords can be found.

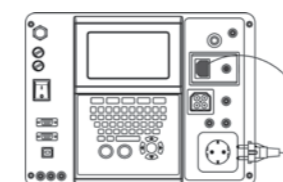

Polarity test

Measurement of load and leakage currents with current clamps

Advantages of clamp measurements are:

- Measured electrical equipment does not need to be disconnected from the mains.
- Selective current tests can be performed by embracing individual conductors.
- Individual currents can be measured without disconnections.

Current clamps are best suited for:

- functional testing of fixed installed appliances;
- functional testing of appliances with nominal currents >16 A;
- troubleshooting of current paths in appliances.

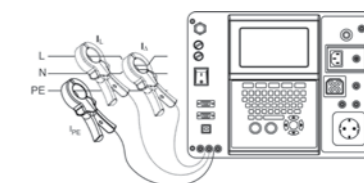

Current measurement with current clamps

Appliance must be powered on. By embracing separate conductors load or leakage currents can be measured.

Functional test

Functional check explores if the appliance is working properly. The use of more sophisticated measuring instruments permits load testing, which is an effective way of determination if there are faults in the appliance.

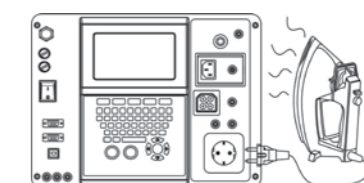

Functional test

PRCD test

This test checks how long it takes for a portable RCD to trip out in the case that a fault occurs.



PRCD testing

Testing PAT

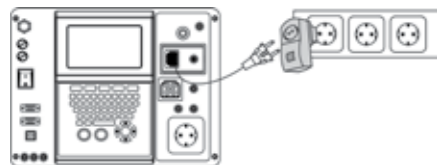

PRCD testing

Active polarity test

This test provides testing of PRCD protected cords while voltage is applied to tested object.

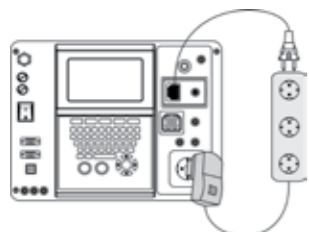

Active polarity test

Autosequences

All Metrel PAT testers contain built-in predefined test sequences which are specified sets of measurements, limits and test parameters. To select the correct test sequence first the type and class of appliance must be determined. Then all safety relevant accessible conductive parts must be found. After that the test sequence, test lim-

its and parameters must be selected. It is of a great advantage if this can be made automatically by the measuring instrument.

Custom test sequences

In case of testing unusual appliances or appliances that require a special method of testing that is not included in the standard autosequences custom defined test sequences can be used.

Project uploading

When retesting a site or location, project uploading allows previously saved information to be reloaded onto the PAT tester to speed up testing and enable trend comparison.

Trend comparison

Trend comparison allows test information from different dates to be compared in order to discover if deterioration is occurring in an appliance. In case the deterioration was found, the test engineer can make an informed decision as to if the frequency of testing and inspection is sufficient for the appliance.

Guide through Verification on Low-voltage electrical installations : VDE 701/702



Selection Guide for PAT testers

Part No.	MI 3305 OmegaGT Plus	MI 3304 BetaGT Plus	MI 3310 25A SigmaGT	MI 3310 SigmaGT	MI 3309 BT DeltaGT	MI 3311 GammaGT	MI 2142 AlphaPAT
MEASUREMENTS							
Continuity 200 mA	✓	✓	✓	✓	✓	✓	✓
Continuity 10 A	✓	✓	✓	-	-	-	✓
Continuity 25 A	✓	✓	✓	-	-	-	✓
Insulation resistance 250 Vdc	✓	✓	✓	✓	✓	✓	✓
Insulation resistance 500 Vdc	✓	✓	✓	✓	✓	✓	✓
Differential leakage current	✓	✓	✓	✓	✓	-	✓
Touch leakage current	✓	✓	✓	✓	✓	-	✓
Substitute leakage current	✓	✓	✓	✓	✓	✓	✓
Leakage current measurements with optional clamp	✓	✓	✓	✓	✓	-	✓
Flash test	✓	-	-	-	-	-	-
PRCD testing	✓	✓	✓	✓	✓	-	-
Polarity test (IEC lead test)	✓	✓	✓	✓	✓	✓	✓
Functional (load) test	✓	✓	✓	✓	✓	-	✓
Voltage TRMS	-	-	✓	✓	✓	✓	-
ADDITIONAL FEATURES							
PASS / FAIL evaluation	✓	✓	✓	✓	✓	✓	✓
Mains supply check	✓	✓	✓	✓	✓	✓	✓
Built-in Checkbox	-	-	Option	Option	-	✓	-
Graphical LCD	✓	✓	✓	✓	✓	✓	✓
Graphical on-line help	✓	✓	✓	✓	✓	✓	✓
Backlight	✓	✓	✓	✓	✓	✓	✓
Real time clock	✓	✓	✓	✓	✓	✓	✓
QWERTY keyboard	✓	✓	✓	✓	-	-	-
Auto testing (organizer, custom autotests)	✓	✓	✓	✓	✓	✓	✓
Barcode shortcut auto testing	✓	✓	✓	✓	✓	✓	✓
Communication ports USB / RS232 / BLUETOOTH	✓ / ✓ / -	✓ / ✓ / -	✓ / ✓ / ✓	✓ / ✓ / -	✓ / ✓ / ✓	✓ / ✓ / Option	Option / ✓ / -
"Test and tag" (barcode scanner + label printer)	✓	✓	✓	✓	✓	✓	-
Data download to PC	✓	✓	✓	✓	✓	✓	✓
Project upload from PC	✓	✓	✓	✓	-	-	-
Trend (compare) on instrument's LCD	✓	✓	✓	✓	-	-	-
Trend with PC SW PATLink PRO Plus	✓	✓	✓	✓	-	-	-
Number of memory locations	6500	6500	6000	6000	1500	1500	1100
STANDARD / OPTIONAL ACCESSORIES							
Barcode scanner	Option	Option	Option	Option	Option	Option	Option
Barcode label printer	-	-	Option	Option	Option	Option	-
QR label printer	Option	Option	Option	Option	Option	Option	-
Receipt printer	Option	Option	Option	Option	Option	Option	-
Basic PC SW	✓	✓	✓	✓	✓	Option	Option
Advanced PC SW	Option	Option	Option	Option	Option	Option	-
Android APP	-	-	Option	-	Option	Option	-
GENERAL DATA							
Weight	8.4 kg		5 kg		0.86 kg	0.86 kg	3.5 kg
Dimensions	345 x 160 x 335		310 x 130 x 250		140 x 80 x 230	140 x 80 x 230	265 x 110 x 185

MI 3305 OmegaGT Plus and MI 3304 BetaGT Plus

The innovative MI 3305 OmegaGT Plus and MI 3304 BetaGT Plus are a high-class instruments intended for electrical safety testing of a wide range of portable electrical appliances, IT equipment, IEC cords and portable RCDs according to IEC/EN and VDE standards. This portable, self-contained and durable instruments can be moved between sites with minimum time and effort. The large, bright LCD screen enables work with the instrument in almost all lighting conditions. New features including portable RCD testing, clamp leakage current measurement, flash test (MI 3305 only), project uploading, recall and retest functions, fixed appliance test ports, optional PASS/FAIL label printing and on-site test result comparison make this instruments perfect for PAT testing in almost any situation.

MEASURING FUNCTIONS:

- Continuity tests (200 mA, 10 A, 25 A);
- Insulation resistance;
- Substitute leakage current;
- Differential leakage current;
- Touch leakage current;
- IEC cord polarity test;
- Leakage and load TRMS current measurement with current clamp.
- Portable RCD testing;
- HV Flash test (MI 3305 only);
- Functional test.

KEY FEATURES:

- **Autosequencing:** 24 pre-set autosequences and custom prepared autosequences speed up testing and ensure that no tests are missed.
- **Automated:** automatic testing and PASS / FAIL evaluation of test results according to appropriate standard.
- **Project uploading:** previous test data can be uploaded for fast retesting of the appliance.
- **Scan and test:** optional barcoding system and PASS / FAIL barcode label printing make retesting quick and simple.
- **RFID:** support for advanced RFID identification system.
- **User friendly:** large LCD screen, full QWERTY keyboard, help screens and warnings make the instrument an extremely easy to use.
- **Multi-tasking:** instrument performs continuity tests with different test currents, 250 V and 500 V insulation tests, differential /substitute / touch leakage measurements, functionoal and polarity tests.
- **Flash test:** dielectric strength test after repair safety testing (MI 3305 only).
- **PRCD testing:** instrument enables measurement of trip-out time of portable RCDs.
- **Clamp leakage current measurement:** quick measurement of leakage current with current clamps directly on power supply cable without disconnection of appliance from mains.
- **Trend functionality:** test results can be uploaded from PC to the instrument for comparison between old and new



test results on-site.

- **Downloadable:** up to 6500 test results with measuring parameters can be stored in two level memory and downloaded to the PC with the help of PC SW PATLink PRO.
- **PC SW PATLink PRO** included in the standard set enables downloading, viewing, printing of test results and exporting of data to spreadsheet applications.
- **PC SW PATLink PRO Plus** enables advanced analysis of test results, upload of structures and data upload to the instrument for on site comparison of old and new results, upload of pre-programmed custom autosequences and creation of professional test reports.

APPLICATION:

- Professional PAT testing;
- General PAT testing;
- Factory / warehouse PAT testing;
- After repair PAT safety testing.

STANDARDS:

Functionality:
IEC 60335-1; IEC 60598-1; IEC 60745;
IEC 60745; VDE404-1; VDE404-2;
VDE 0701; VDE 0702

Electromagnetic compatibility:
EN 61326

Safety: EN 61010-1; EN 61010-031

TECHNICAL SPECIFICATION:

Function	Measuring range	Resolution	Accuracy
PE continuity (10 A, 25 A)	0.00 Ω ... 1.99 Ω 2.00 Ω ... 19.99 Ω	0.01 Ω 0.01 Ω	±(5 % of reading + 3 digits) ±(10 % of reading)
PE continuity (200 mA)	0.00 Ω ... 1.99 Ω 2.00 Ω ... 9.99 Ω 10.0 Ω ... 19.9 Ω	0.01 Ω 0.01 Ω 0.1 Ω	±(5 % of reading + 3 digits) ±(5 % of reading + 5 digits) ±(5 % of reading + 5 digits)
Insulation resistance (250 V _{DC} , 500 V _{DC})	0.000 MΩ ... 0.500 MΩ 0.501 MΩ ... 1.999 MΩ 2.00 MΩ ... 19.99 MΩ 20.0 MΩ ... 199.9 MΩ	0.001 MΩ 0.001 MΩ 0.01 MΩ 0.1 MΩ	±(10 % of reading + 5 digits) ±(5 % of reading + 3 digits) ±(5 % of reading + 3 digits) ±(5 % of reading + 3 digits)
Substitute leakage current	0.00 mA ... 19.99 mA	0.01 mA	±(5 % of reading + 5 digits)
Touch leakage current	0.00 mA ... 1.99 mA	0.01 mA	±(10 % of reading + 5 digits)
Differential leakage current	0.00 mA ... 9.99 mA	0.01 mA	±(5 % of reading + 5 digits)
Functional test: apparent power	0.00 kVA ... 4.00 kVA	0.01 kVA	±(5 % of reading + 3 digits)
Current with clamp-on adapter	0.00 mA ... 9.99 mA 10.0 mA ... 99.9 mA 100 mA ... 999 mA 1.00 A ... 9.99 A 10.0 A ... 24.9 A	0.01 mA 0.1 mA 1 mA 0.01 A 0.1 A	±(5 % of reading + 5 digits)
Flash insulation test (MI 3305 only)	0.00 mA ... 2.50 mA	0.01 mA	±(5 % of reading + 5 digits)
Portable RCD: trip-out time (I _{ΔN} = 10 mA, 15 mA, 30 mA)	0 ms ... 1999 ms (½xI _{ΔN}) 0 ms ... 300 ms (I _{ΔN}) 0 ms ... 40 ms (5xI _{ΔN})	1 ms 1 ms 1 ms	±3 ms
Polarity test	Test voltage < 50 V _{AC}		
Power supply	115 V / 230 V, 50 Hz / 60 Hz		
Overvoltage category	CAT II / 300 V		
Protection class	I		
COM port	RS232 and USB		
Dimensions	345 x 160 x 335 mm		
Weight	8.4 kg		

KEY FEATURES



Fast and easy access to test procedure: select the auto test and press START.

Input / output ports:

- Barcode reader
- Printer
- PC

STANDARD SET:

- MI 3305 or MI 3304**
- Instrument OmegaGT Plus or BetaGT Plus
 - Continuity / Leakage cable
 - PRCD cable
 - Flash cable (MI 3305 only)
 - PC SW PATLink PRO
 - RS232 cable
 - USB cable
 - Crocodile clip, green
 - Crocodile clip, black
- Test probe, green
 - Test probe, black
 - Test lead, green 1.5 m
 - Test lead, black 1.5 m
 - Instruction manual
 - Calibration certificate



MI 3305

MI 3310 25A SigmaGT and MI 3310 SigmaGT

The MI 3310 / MI 3310 25A SigmaGT is a multifunctional portable test instrument intended to perform all measurements for complete testing the electrical safety of portable electrical equipment. Along with numerous features like dual power supply support, built-in battery charger, lightweight design, large bright LCD, soft Qwerty keypad, internal memory for up to 6000 results and Bluetooth technology, the instrument offers innovative solution for RCD protected cords testing and enables testing of fixed appliances. Powerful data management PC software PATLink PRO enables upload and download of test results and parameters for further data handling, trend analysis and test report creation.

MEASURING FUNCTIONS:

- Earth bond resistance with 10 A, 25 A (MI 3310 25A);
- Continuity test with 200 mA;
- Insulation resistance;
- Insulation resistance of isolated accessible conductive parts;
- Substitute leakage current;
- Substitute leakage current of isolated accessible conductive parts;
- Differential leakage current;
- Touch leakage current;
- IEC cord polarity test;
- Leakage and load currents with current clamp;
- RCD and portable RCD testing;
- Functional test.

KEY FEATURES:

- **Autosequencing:** pre-programmable VDE compatible autosequences, up to 50 custom prepared autosequences and barcode autotests speed up testing and ensure that no tests are missed.
- **Active polarity:** innovative solution for testing of RCD protected cords while voltage is applied to the tested item.
- **Dual powered:** instrument can be powered from both internal battery and mains supply (115 V and 230 V).
- **Fixed appliance testing:** additional inputs and optional accessories enable testing of fixed installed appliances.
- **Scan and test:** optional barcoding system and PASS / FAIL barcode label printing make retesting quick and simple.
- **RFID:** support for advanced RFID identification system.
- **Project uploading:** previous test data can be uploaded for fast retesting of the object.
- **Trend functionality:** test results can be uploaded from PC to the instrument for comparison between old and new test results on site.
- **Memory:** up to 6000 test results with parameters can be stored into memory and downloaded to the PC with the help of PC SW PATLink PRO.
- **User friendly:** large LCD screen, full QWERTY keyboard, help screens and warnings make handling the instrument very simple and clear.
- **Clamp leakage current measurement:** quick measurement of leakage current with current clamps directly on power supply cable without disconnection of



appliance from mains.

- **RCD testing:** instrument enables testing of parameters of RCDs and portable RCDs.
- **Bluetooth:** enables communication with PC, printers, and Android devices.
- **Android application:** enables advanced data management, use of smart phones camera for scanning QR and bar-code.
- **PC SW PATLink PRO** included in the standard set enables downloading, viewing, printing of test results and exporting of data to spreadsheet applications.
- **PC SW PATLink PRO Plus** enables advanced analysis of test results, upload of structures and data upload to the instrument for on site comparison of old and new results, upload of pre-programmed custom autosequences and creation of professional test reports.

APPLICATION:

- Professional PAT safety testing;
- General PAT safety testing;
- Multi-location PAT safety testing.

STANDARDS:

Functionality:

VDE 0404-1; VDE 0404-2; VDE 0701-0702; AS / NZS 3760; NEN 3140

Electromagnetic compatibility:

EN 61326-1

Safety:

EN 61010-1; EN 61010-031; EN 61010-2-032

TECHNICAL SPECIFICATION:

Function	Measuring range	Resolution	Accuracy
Earth bond resistance, 10 A, 25 A (MI 3310 25A only)	0.00 Ω ... 1.99 Ω	0.01 Ω	±(5 % of reading + 3 digits)
	2.00 Ω ... 19.99 Ω	0.01 Ω	±10 % of reading
PE continuity, 200 mA	0.00 Ω ... 1.99 Ω	0.01 Ω	±(5 % of reading + 3 digits)
	2.00 Ω ... 9.99 Ω	0.01 Ω	±10 % of reading
	10.0 Ω ... 19.9 Ω	0.1 Ω	±10 % of reading
Insulation resistance (250 V _{DC} , 500 V _{DC})	0.000 MΩ ... 0.500 MΩ	0.001 MΩ	±(10 % of reading + 5 digits)
	0.501 MΩ ... 1.999 MΩ	0.001 MΩ	±(5 % of reading + 3 digits)
	2.00 MΩ ... 19.99 MΩ	0.01 MΩ	±(5 % of reading + 3 digits)
	20.0 MΩ ... 199.9 MΩ	0.1 MΩ	±(5 % of reading + 3 digits)
Substitute leakage current	0.00 mA ... 19.99 mA	0.01 mA	±(5 % of reading + 5 digits)
Touch leakage current	0.00 mA ... 3.99 mA	0.01 mA	±(10 % of reading + 5 digits)
Differential leakage current	0.00 mA ... 9.99 mA	0.01 mA	±(5 % of reading + 5 digits)
Functional test: apparent power	0.00 kVA ... 4.00 kVA	0.01 kVA	±(5 % of reading + 3 digits)
Current with current clamp	0.00 mA ... 9.99 mA	0.01 mA	±(5 % of reading + 10 digits)
	10.0 mA ... 99.9 mA	0.1 mA	±(5 % of reading + 5 digits)
	100 mA ... 999 mA	1 mA	±(5 % of reading + 5 digits)
	1.00 A ... 9.99 A	0.01 A	±(5 % of reading + 5 digits)
	10.0 A ... 24.9 A	0.1 A	±(5 % of reading + 5 digits)
Portable RCD: trip-out time (I _{ΔN} = 10 mA, 15 mA, 30 mA)	0 ms ... 300 ms (½xI _{ΔN})	1 ms	±3 ms
	0 ms ... 300 ms (I _{ΔN})	1 ms	
	0 ms ... 40 ms (5xI _{ΔN})	1 ms	
RCD: trip-out time (I _{ΔN} = 10 mA, 15 mA, 30 mA)	0 ms ... 300 ms (½xI _{ΔN})	0.1 ms	±3 ms
	0 ms ... 300 ms (I _{ΔN})	0.1 ms	
	0 ms ... 40 ms (5xI _{ΔN})	0.1 ms	
Polarity test	Test voltage < 50 V _{AC}		
Power supply	6 x 1.2 V NiMH rechargeable batteries, type C; 115 V / 230 V, 50 Hz / 60 Hz		
Overvoltage category	CAT II / 300 V		
COM port	RS232, USB and Bluetooth (MI 3310A only)		
Dimensions	310 x 130 x 250 mm		
Weight	5 kg		

STANDARD SET:

MI 3310 25A

- Instrument MI 3310 25A SigmaGT
- Small soft carrying bag
- Test lead, 1.5 m, 3 pcs (brown, green, black)
- Crocodile clip, 3 pcs (brown, green, black)
- Test probe, 3 pcs (brown, green, black)
- IEC test cable, 2 m
- Mains cable 16 A
- NiMH rechargeable batteries, type C, 6 pcs

- PC software PATLink PRO
- RS232 cable
- USB cable
- Instruction manual on CD
- Short instruction manual
- Calibration certificate



STANDARD SET:

MI 3310

- Instrument MI 3310 SigmaGT
- Small soft carrying bag
- Test lead, black, 1.5 m
- Crocodile clip, black
- Test probe, black
- IEC test cable, 2 m
- Mains cable 16 A
- NiMH rechargeable batteries, type C, 6 pcs
- PC software PATLink PRO

- RS232 cable
- USB cable
- Instruction manual on CD
- Short instruction manual
- Calibration certificate



MI 3309 BT DeltaGT

The new MI 3309 BT DeltaGT is both battery and mains powered multifunctional instrument intended to perform measurements for testing the electrical safety of portable electrical equipment. Integrated unique PRCD testing technology prevents tripping out of mains RCD during measurement. Due to dual power capability of MI 3309 it enables performing of differential leakage current test in spite of its lightweight portable design. Large graphical LCD with backlight, two PASS / FAIL LED indicators and HELP screens for each measurement make the handling of the instrument clear and simple. Up to 1500 test results with parameters can be stored in the internal memory of the instrument and then downloaded to the PC for further data handling and creation of test report. Lightweight design, pre-programmed and custom test sequences, optional barcoding, android keyboard application and RFID systems make the MI 3309 an ideal instrument for high volume professional safety testing of portable appliances.

MEASURING FUNCTIONS:

- Functional and visual inspection;
- Earth bond resistance;
- Insulation resistance;
- Insulation resistance of isolated accessible conductive parts;
- Substitute leakage current;
- Substitute leakage current of isolated accessible conductive parts;
- Differential leakage current test;
- Touch leakage test;
- RCD and portable RCD testing;
- Power test;
- IEC cord polarity test;
- Leakage and load currents with current clamp;
- TRMS voltage meter.

KEY FEATURES:

- **Autosequencing:** pre-programmable VDE compatible autosequences, up to 50 custom prepared autosequences and barcode autotests speed up testing and ensure that no tests are missed.
- **Dual powered:** the instrument can operate from mains power or batteries.
- **PASS / FAIL:** large green and red lights for additional PASS / FAIL indication placed at the sides of the LCD.
- **Fixed appliance testing:** additional inputs and optional accessories enable testing of fixed installed appliances.
- **Scan and test:** optional barcoding system and PASS/FAIL barcode label printing make retesting quick and simple.
- **RFID:** support for advanced RFID identification system.
- **RCD testing:** instrument enables testing of parameters of RCDs and portable RCDs.
- **Memory:** large data flash memory allows to store up to 1500 test results and parameters for further downloading to PC.
- **Built-in charger & rechargeable batteries:** instrument has a built-in charging circuit and comes complete with a

set of rechargeable NiMH batteries.

- **Bluetooth:** enables communication with PC, printers, and Android devices.
- **Android application:** enables advanced data management, use of smart phones camera for scanning QR and bar-code.
- **PC SW PATLink PRO** included in the standard set enables downloading, viewing, printing of test results and exporting of data to spreadsheet applications.
- **PC SW PATLink PRO Plus** enables advanced analysis of test results, upload of pre-programmed custom autosequences and creation of professional test reports.



APPLICATION:

- Professional PAT safety testing;
- General PAT safety testing;
- After repair PAT safety testing.

STANDARDS:

Functionality:
EN 61557; VDE 0404-1; VDE 0404-2;
VDE 0701-0702; NEN 3140
Electromagnetic compatibility:
EN 61326
Safety: EN 61010-1; EN 61010-031

TECHNICAL SPECIFICATION:

Function	Measuring range	Resolution	Accuracy
PE continuity (200 mA)	0.00 Ω ... 19.99 Ω 20.0 Ω ... 199.9 Ω 200 Ω ... 1999 Ω	0.01 Ω 0.1 Ω 1 Ω	±(5 % of reading + 3 digits) Indication only Indication only
Insulation resistance (250 V _{DC} , 500 V _{DC})	0.00 MΩ ... 19.99 MΩ 20.0 MΩ ... 49.9 MΩ 50.0 MΩ ... 199.9 MΩ	0.01 MΩ 0.1 MΩ 0.1 MΩ	±(5 % of reading + 3 digits) ±(5 % of reading + 3 digits) Indication only
Substitute leakage current (30 V _{AC})	0.00 mA ... 9.99 mA 10.0 mA ... 20.0 mA	0.01 mA 0.1 mA	±(5 % of reading + 3 digits) ±(5 % of reading + 3 digits)
Touch leakage current	0.00 mA ... 7.00 mA	0.01 mA	±(10 % of reading + 5 digits)
Differential leakage current	0.00 mA ... 19.99 mA	0.01 mA	±(5 % of reading + 5 digits)
Functional test: apparent power	0.00 kVA ... 4.00 kVA	0.01 kVA	±(5 % of reading + 3 digits)
RCD and portable RCD: trip-out time (I _{ΔN} = 10 mA, 15 mA, 30 mA)	0 ms ... 300 ms (½xI _{ΔN}) 0 ms ... 300 ms (I _{ΔN}) 0 ms ... 40 ms (5xI _{ΔN})	0.1 ms 0.1 ms 0.1 ms	±3 ms ±3 ms ±1 ms
Clamp current	0.00 mA ÷ 9.99 mA 10.0 mA ÷ 99.9 mA 100 mA ÷ 999 mA 1.00 A ÷ 9.99 A 10.0 A ÷ 16.0 A	0.01 mA 0.1 mA 1 mA 0.01 A 0.1 A	±(5 % of reading + 10 digits) ±(5 % of reading + 5 digits) ±(5 % of reading + 5 digits) ±(5 % of reading + 5 digits) ±(5 % of reading + 5 digits)
Voltage TRMS	80 V ... 300 V	1 V	±(2 % of reading + 2 digits)
Polarity test	Test voltage < 50 V _{AC}		
Power supply	6 x 1.2 V NiMH rechargeable batteries, type AA; 230 V, 50 Hz / 60 Hz		
Overvoltage category	CAT II / 300 V		
COM port	RS232, USB and Bluetooth		
Dimensions	140 x 80 x 230 mm		
Weight	1.2 kg		

STANDARD SET:

- MI 3309**
- Instrument MI 3309 BT DeltaGT
 - Small soft carrying bag
 - IEC cable, 2 m, 2 pcs
 - Test lead, black, green, brown, 1.5 m
 - Crocodile clip, black, green, brown
 - Test probe, black, green, brown
 - PC software PATLink PRO
 - RS232 cable
 - USB cable
- NiMH rechargeable batteries, type AA, 6 pcs
 - Instruction manual on CD
 - Short instruction manual
 - Calibration certificate



KEY FEATURES



Inputs for testing fixed appliances.



Large LCD screen with backlight and PASS / FAIL indicators.



MI 3311 GammaGT

The new MI 3311 GammaGT is a battery powered multifunctional instrument intended to perform measurements for testing the electrical safety of portable electrical equipment. Due to large graphical LCD with backlight, two PASS / FAIL LED indicators and HELP screens for each measurement the handling of the instrument is clear and simple. Up to 1500 test results with parameters can be stored in the internal memory of the instrument and then downloaded to the PC for further data handling and creation of test report. Lightweight design, pre-programmed and custom test sequences, optional barcoding, android keyboard application and RFID systems and built-in calibration unit make the MI 3311 an ideal instrument for high volume professional safety testing of portable appliances.

MEASURING FUNCTIONS:

- Continuity test with 200 mA;
- Insulation resistance;
- Insulation resistance of isolated accessible conductive parts;
- Substitute leakage current;
- Substitute leakage current of isolated accessible conductive parts;
- IEC cord polarity test;
- TRMS voltage;
- Functional and visual inspection.

KEY FEATURES:

- **Autosequencing:** pre-programmable VDE compatible autosequences, up to 50 custom prepared autosequences and barcode autotests speed up testing and ensure that no tests are missed.
- **Checkbox:** built-in calibration unit performs calibration of the instrument and the calibration results are automatically stored into instrument's memory.
- **PASS / FAIL:** large green and red lights of the LEDs indicate a PASS or FAIL evaluation of test result.
- **Scan and test:** optional barcoding system and PASS / FAIL barcode label printing make retesting quick and simple.
- **RFID:** support for advanced RFID identification system.
- **User friendly:** large LCD screen, two Pass / Fail LED indicators, help screens and warnings make the instrument an extremely easy to use.
- **Multi-tasking:** instrument performs continuity test, 250 V and 500 V insulation tests, substitute leakage measurement, functional and polarity tests.
- **Memory:** up to 1500 test results with measuring parameters can be stored in two level memory and downloaded to the PC with the help of PC SW PATLink PRO.
- **Built-in charger & rechargeable bat-**



- teries:** instrument has a built-in charging circuit and comes complete with a set of rechargeable NiMH batteries.
- **Android application:** enables advanced data management, use of smart phones camera for scanning QR and bar-code.
- **PC SW PATLink PRO** enables downloading, viewing, printing of test results and exporting of data to spreadsheet applications.
- **PC SW PATLink PRO Plus** enables advanced analysis of test results, upload of pre-programmed custom autosequences, creation of professional test reports.

APPLICATION:

- Professional PAT testing;
- General PAT testing;
- After repair PAT safety testing.

STANDARDS:

- Functionality:** EN 61557; VDE 0404-1; VDE 0404-2; VDE 0701; VDE 0702; NEN 3140
- Electromagnetic compatibility:** EN 61326
- Safety:** EN 61010-1; EN 61010-031

TECHNICAL SPECIFICATION:

Function	Measuring range	Resolution	Accuracy
PE continuity (200 mA)	0.00 Ω ... 19.99 Ω 20.0 Ω ... 199.9 Ω 200 Ω ... 1999 Ω	0.01 Ω 0.1 Ω 1 Ω	±(5 % of reading + 3 digits) Indication only Indication only
Insulation resistance (250 V _{DC} , 500 V _{DC})	0.00 MΩ ... 19.99 MΩ 20.0 MΩ ... 49.9 MΩ 50.0 MΩ ... 199.9 MΩ	0.01 MΩ 0.1 MΩ 0.1 MΩ	±(5 % of reading + 3 digits) ±(5 % of reading + 3 digits) Indication only
Substitute leakage current	0.00 mA ... 9.99 mA 10.0 mA ... 20.0 mA	0.01 mA 0.1 mA	±(5 % of reading + 3 digits) ±(5 % of reading + 3 digits)
Voltage	0 V ... 300 V	1 V	±(2 % of reading + 2 digits)
Polarity test	Test voltage < 50 V _{AC}		
Power supply	6 x 1.2 V NiMH rechargeable batteries, type AA		
Overvoltage category	CAT II / 300 V		
COM port	RS232, USB and Bluetooth (optional A 1436 BT dongle)		
Dimensions	140 x 80 x 230 mm		
Weight	0.86 kg		

STANDARD SET:

- MI 3311**
 - Instrument GammaGT
 - Small soft carrying bag
 - IEC cable, 2 m
 - Test probe, black
 - Test lead, black, 1.5 m
 - Crocodile clip, black
 - Power supply adapter
 - NiMH rechargeable batteries, type AA, 6 pcs
- Instruction manual
- Calibration certificate



KEY FEATURES



Large LCD screen with backlight and PASS / FAIL indicators.



Simple and fast manipulation.



USB and PS/2 connectors for communication with PC and barcode scanner.

MI 2142 AlphaPAT

AlphaPAT is a handheld instrument intended for safety testing of electrical portable appliances, information technology equipment and IEC cords. Autosequence mode offers 110 pre-programmed autotests based on appliance type and class, length of supply cord, maximum current capacity etc. and allows to program up to 50 custom test sequences for speed-up appliance's safety testing. Internal memory of the instrument allows to store up to 1100 results and then download them to the PC for storage and report creation with the help of the PC SW PATLink PRO included in the standard set. The simple menu system, bright LCD screen, optional barcoding system, automated PASS / FAIL evaluation of test results and built-in help screens make this instrument an extremely easy to use.

MEASURING FUNCTIONS:

- Continuity tests (200 mA, 10 A, 25 A);
- Insulation resistance;
- Substitute leakage current;
- Differential leakage current;
- Touch leakage current;
- IEC cord polarity test;
- Leakage and load TRMS current measurement with current clamp;
- Functional test.

KEY FEATURES:

- **Autosequencing:** built in Autosequences speed up testing and ensure no tests are missed.
- **Automated:** automatic testing and Pass/Fail evaluation of results according to the code of practice.
- **Adaptable:** tests both 230 V appliances and 115 V appliances (via socket adapter included in standard set).
- **Multi-tasking:** can perform Hard and Soft Earth Bond test, 250 V / 500 V insulation tests, differential /substitute / touch leakage test, Load tests, fuse tests and polarity tests.
- **Intelligent:** hard or soft tests are chosen automatically to reduce the risk of damage occurring on the selected appliance.
- **Downloadable:** with memory capacity of 1100 locations, the unit can be downloaded to a computer via the PATLink software (included in the standard set).

APPLICATION:

- Domestic PAT testing;
- Hotel PAT testing;
- General PAT testing;
- Factory / warehouse PAT testing.



STANDARDS:

Functionality:

VDE 0701;
VDE 0702;
BS 89;
IEC 60335-1;
IEC 60598-1;
IEC 60745;
IEC 60950

Electromagnetic compatibility:

EN 61326

Safety:

EN 61010-1

STANDARD SET:



MI 2142

- Instrument AlphaPAT
- Carrying bag
- Continuity / Leakage cable
- PC software PATLink PRO
- Instruction manual
- Calibration certificate

TECHNICAL SPECIFICATION:

Function	Measuring range	Resolution	Accuracy
PE continuity (25 A, 10 A, 200 mA)	0.00 Ω ... 19.99 Ω	0.01 Ω	±(5 % of reading + 3 digits)
Insulation resistance (250 V _{DC} , 500 V _{DC})	0.000 MΩ ... 0.500 MΩ	0.001 MΩ	±(10 % of reading + 5 digits)
	0.501 MΩ ... 1.999 MΩ	0.001 MΩ	±(5 % of reading + 3 digits)
	2.00 MΩ ... 19.99 MΩ	0.01 MΩ	±(5 % of reading + 3 digits)
Substitute leakage current	0.00 mA ... 19.99 mA	0.01 mA	±(5 % of reading + 5 digits)
Differential leakage current	0.00 mA ... 19.99 mA	0.01 mA	±(5 % of reading + 5 digits)
Touch leakage current	0.00 mA ... 1.99 mA	0.01 mA	±(5 % of reading + 5 digits)
Functional test	0.00 kVA ... 3.70 kVA	0.01 kVA	±(10 % of reading + 3 digits)
Current with clamp-on adapter	0.00 mA ... 9.99 mA	0.01 mA	±(5 % of reading + 5 digits)
	10.0 mA ... 99.9 mA	0.1 mA	±(5 % of reading + 5 digits)
	100 mA ... 999 mA	1 mA	±(5 % of reading + 5 digits)
	1.00 A ... 9.99 A	0.01 A	±(5 % of reading + 5 digits)
	10.0 A ... 24.9 A	0.1 A	±(5 % of reading + 5 digits)
Power supply	230 V, 50 Hz / 60 Hz		
Overvoltage category	CAT II / 300 V		
Protection class	I		
COM port	RS232		
Dimensions	265 x 110 x 185 mm		
Weight	3.5 kg		

KEY FEATURES



Mobile phone type keypad for fast entering of appliance data and date.



Input / output ports: barcode reader, RFID reader / writer, printer, PC.



Small and lightweight design makes AlphaPAT ideal for PAT testing on variety of environments.

A 1322 and A 1422 Active 3-phase Adapter

Metrel's all new A 1322 Multifunctional test adapter is designed for troubleshooting, as well as for periodic testing on 3-phase appliances and machinery. Unique functions such as, active polarity testing, differential leakage testing and testing of 3-phase RCD's make the A 1322 Active 3-phase Adapter an ideal instrument for advanced applications. The A 1322 adapter is designed for use alongside the MI 3321 MultiservicerXA and the MI 3310/MI 3310 25A SigmaGT enabling functional tests to be carried out on machines up to 40 A. Several test socket outlets make this instrument an ideal tester for testing industrial extension leads that may also be RCD protected.

The A 1422 Multifunctional test adapter has complete support for testing of Arc Welding Equipment in accordance to EN 60974-4 and VDE 0544-4.

Due to the powerful test data management included with both supporting test instruments, all test data can easily be equipped with needed parameters. This data can be stored into the large memory included, and with the support of the powerful data management system PC SW Patlink Pro, exported as professional test reports.

KEY FEATURES:

- Testing of Open-Circuit Voltage at ARC Welding Units in accordance to EN 60974-4 (1422 only).
- All tests on 3-phase electrical equipment can be carried out, including live leakage test, power, polarity, RCD and Active polarity.
- Simple connection to the PAT/MACHINE tester with automatic detection.
- Simple test procedures, identical to single phase equipment.
- Test sequence for 3-phase tests are automatically set, based on entered test codes and input voltages.
- Built-in CEE 3-PH/32A 5 pin, CEE 3-PH/16A 5 pin and CEE 1-PH/16A 3 pin test sockets.
- Instrument comes complete with all accessories necessary for comfortable measurements and kept in a robust waterproof case.

APPLICATION:

- Testing of single and 3-phase ARC Welding equipment (1422 only);
- Professional 3-PH portable appliance testing;
- Professional 3-PH machine testing.

STANDARDS:

Functionality:

EN 60974-4; VDE 0544-4; VDE 0404-1; VDE 0404-2; VDE 0701-0702; EN 60204-1 Ed.5; EN 60439; EN 61439-1; AS / NZS 3760; NEN 3140

Electromagnetic compatibility:

EN 61326-1

Safety:

EN 61010-1; EN 61010-031



STANDARD SET:

A 1322

- Active 3-Phase Adapter
- Bag for accessories
- Connection cable between Adapter and Instrument
- 3-phase mains cable 16 A male / 32 A female, 5 pin, 2 m
- RS232 cable
- Instruction manual, short instruction manual
- Calibration certificat

A 1422

- Test lead, 1.5 m, (blue, red)
- Test probe, (blue, red)



A 1422

TECHNICAL SPECIFICATION:

Function	Measuring range	Resolution	Accuracy
Differential leakage current (230/400 VAC or 120/208 VAC)	0.00 mA ... 9.99 mA	0.01 mA	±(5 % of reading + 5 digits)
Power / Functional test (230/400 VAC or 120/208 VAC)	0.00 kVA ... 24.29 kVA	0.01 kVA	±(5 % of reading + 5 digits)
Active power readout	0.00 kW ... 24.29 kW	0.01 kW	±(5 % of reading + 5 digits)
Reactive power readout	0.00 kVAr ... 24.29 kVAr	0.01 kVAr	±(5 % of reading + 5 digits)
Power factor readout	0.00 ... 1.00	0.01	±(5 % of reading + 5 digits)
3-phase RCD / Test current (10 mA, 15 mA, 30 mA, 100 mA, 300 mA)	0 ms ... 300 ms (½ x I _{ΔN} , I _{ΔN}) 0 ms ... 150 ms (2 x I _{ΔN}) 0 ms ... 40 ms (5 x I _{ΔN})	1 ms 1 ms 1 ms	±3 ms ±3 ms ±3 ms
Portable RCD trip-out current readout (B type PRCD)	0.2 x I _{ΔN} ... 2.2 x I _{ΔN}	0.05 x I _{ΔN}	±0.1 x I _{ΔN}
Power supply	230 V ±10 %		
Overtoltage category	CAT II / 300 V		
Protection class	I		
COM port	RS232		
Dimensions	335 x 160 x 335 mm		
Weight	7.2 kg		
A 1422 (only)			
Welding circuit leakage current; Primary leakage current readout	0.00 mA ÷ 14.99 mA	0.01 mA	±(5 % of reading + 5 digits)
No load voltage readout; (AC peak or DC peak) (AC RMS)	0.0 A ÷ 199.9 mA 0.0 A ÷ 139.9 mA	0.1 A 0.1 A	±(5 % of reading + 5 digits) ±(5 % of reading + 5 digits)

KEY FEATURES

A 1322 and A 1422	MI 3310	MI 3310 25A	MI 3321
Earth bond / continuity resistance 200 mA	✓	✓	✓
Earth bond / continuity resistance 10A / 25 A	- / -	✓ / ✓	✓ / -
Continuity (single / auto)	-	-	✓
Insulation resistance	✓	✓	✓
Insulation resistance – s	✓	✓	✓
High voltage test	-	-	✓
Loop impedance and prospective fault current	-	-	✓
Discharging time	-	-	✓
Voltage, frequency, three-phase rotary field	-	-	✓
Substitute leakage current	✓	✓	✓
Substitute leakage – s	✓	✓	✓
Differential leakage current	✓	✓	✓
3-phase differential leakage current	✓	✓	✓
Touch leakage current	✓	✓	✓
Polarity test	✓	✓	✓
Active polarity test	✓	✓	✓
3-phase polarity test / 3-phase active polarity test	✓	✓	✓
Clamp current test	✓	✓	✓
P/RCD test	✓	✓	✓
3-phase P/RCD test	✓	✓	✓
Power / functional test	✓	✓	✓
3-phase power / functional test	✓	✓	✓
A 1422 (only)			
Continuity test (according to IEC/ EN 60974-4)	✓	✓	✓
Insulation resistance (according to IEC/ EN 60974-4)	✓	✓	✓
Leakage current (according to IEC/ EN 60974-4)	✓	✓	✓
No load voltage (according to IEC/ EN 60974-4)	✓	✓	✓

MI 3300 Portable Appliance Simulation Board

The MI 3300 PAT Demoboard is an excellent instrument for teaching or demonstrating PAT testing. The MI 3300 simulates a wide variety of portable equipment in normal operation or in fault conditions with the simple flick of a switch. The strong rugged portable case with detachable lid allows the unit to be easily moved between sites. The ability of the unit to simulate unlimited number of different equipment and the possibility to set fault conditions make the PAT Demoboard the ideal unit for teaching or assessing learning in classrooms, training sessions, demonstration sessions, seminars and on PAT training courses.

KEY FEATURES:

- Practically unlimited number of different equipment (portable appliances, machines and switchgears) can be simulated by using different tables (eight are included in a standard set).
- On demand the demonstration board can be simply upgraded with new tables.
- Normal and fault situations can be switched on and off, offering fault conditions for the assessment of learning.
- Demoboard simulates the following faults: PE continuity faults, insulation resistance faults, leakage and touch leakage faults, polarity and functional faults.
- The demonstration board is built into a strong rugged case with a handle and detachable lid for storing leads, adapters and manuals.

APPLICATION:

- Presentation of complete safety testing of any portable appliance, machine or switchgear;
- Demonstration of PAT test equipment operation by sales personnel.

STANDARDS:

Safety:
EN 61010-1



TECHNICAL SPECIFICATION:

Protection class	I
Nominal input voltage	230 V
Optional on request	115 V
Power consumption	15 VA max.
Overvoltage category	CAT II / 300 V
Frequency range	45 Hz ... 66 Hz
Pollution degree	2
Dimensions	345 x 160 x 335 mm
Weight	2.76 kg

KEY FEATURES



Normal and fault conditions can be switched on and off.



8 demonstration tables (iron, receiver, IEC cord, extension drum, coffee machine, washing machine, switchgear)

STANDARD SET:

- MI 3300**
- Instrument PAT Demoboard
 - 8 demonstration tables (iron, receiver, IEC cord, extension drum, coffee machine, washing machine, switchgear)
 - Jumper
 - IEC cord
 - Mains cable
 - Class I mains cable
 - Class II mains cable
 - Test cable for discharge time testing
 - Carrying bag for demonstration tables
 - Handbook "Electrical Equipment Testing" on CD
 - Instruction manual
 - Calibration certificate



Testing the safety of machines and switchboards

Find out more about testing safety of machines.

Typical hazardous situations related to electrical equipment are:

- failures or faults in the electrical equipment resulting in the possibility of electric shock or electrical fire;
- failures or faults in control circuits resulting in the malfunctioning of the machine;
- disturbances or disruptions in power sources as well as failures or faults in the power circuits resulting in the malfunctioning of the machine;
- loss of continuity of circuits that depends on sliding or rolling contacts, resulting in failure of a safety function;
- electrical disturbances either from outside the electrical equipment or internally generated, resulting in the malfunctioning of the machine;
- release of stored energy (either electrical or mechanical) resulting in electric shock or unexpected movement that can cause injury;
- audible noise at levels that cause health problems to persons;
- surface temperatures that can cause injury.

To verify the electrical safety of machines the appropriate measurements should be performed:

- after erection of machine;
- after installation of machine;
- after upgrading or changing of machine;
- and during periodic retests of machine.

Verification of safety of machines

According to IEC/EN 60204, Ed.5 verification of electrical safety of machines is performed by inspection and measurements:

- Inspection that the electrical equipment complies with its technical documentation;
- Verification of protection against indirect contact by automatic disconnection;

- Insulation resistance test;
- High voltage test;
- Protection against residual voltages;
- Functional tests.

Safety - measurements: Visual test

A visual check must be carried out before each electrical safety test.

The visual inspection discloses most of faults!

A thorough visual check must be carried out before each electrical safety test.

Check of:

- Wiring connection points. Especially PE connections are important !
- Protection covers, housings
- Inscriptions and markings related to safety must be clearly readable.
- Cable layout, radiuses, isolation
- Switches, regulators, lamps, keys
- Parts subjected to wear out
- Electrical and mechanical protection devices (barriers, switches, fuses, alarms)
- Openings, filters
- Technical documentation, instructions for use available
- Installation of the appliance must be performed according to the user manuals.
- During visual inspection the measuring points for the electrical testing have to be determined too.

Check that there are no signs of:

- Damage
- Pollution, moisture, dirt that can jeopardize safety
- Corrosion
- Overheating

Verification of protection against indirect contact by automatic disconnection

This verification step is quite complex and must always be carried out in some

form. The standard EC/EN 60204, Ed.5 allows simplified testing procedures regarding to the status of machine.

The status of the machine can be selected on base of:

- Condition of supplied machine (dismantled, fully assembled);
- Technical documentation (availability of existing verification report of electrical wiring of machine);
- Length of conductors after installation;
- Incoming supply characteristics - loop impedance.

How to select the appropriate machine status and test extent is described in EN/IEC 60204, Table 9.

Once the machine status and test extent are defined the limits for the Continuity and/or ZLOOP test should be defined.

Continuity test

This test determines that the PE and equipotential connections inside the machine have proper resistance that corresponds to their length and cross-section.

Size of test current should be between at least 0.2 A and approximately 10 A. Higher currents are preferred, especially for low resistance values, i.e. larger cross sectional areas and/or lower conductor length.

Before continuity measurement test leads compensation is required to eliminate the influence of test leads resistance and instrument's internal resistance.

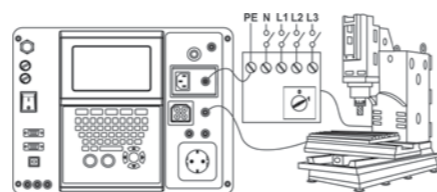

Continuity test

Testing the safety of machines and switchboards

Insulation resistance test

This test discloses faults caused by pollution, moisture, deterioration of insulation metal, etc.

Insulation resistance between live conductors and accessible (earthed or isolated) metal parts is checked.

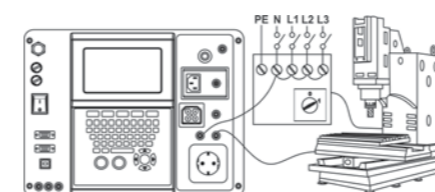

Insulation resistance test

Components and devices that are not rated to withstand the test voltage shall be disconnected during the testing.

Lower test voltages should be used for sensitive electronic equipment and surge protective devices.

High voltage withstanding test

The HV withstanding test is used to confirm integrity of the insulation materials. During the test the insulation materials in the machine are stressed with a higher voltage than during normal operation. A powerful AC high voltage source is applied between the live/ neutral input terminals and the metal housing of the machine. The instrument trips out if the leakage current exceeds the predefined limit.

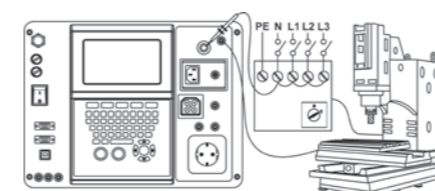

HV withstanding test

Components and devices that are not rated to withstand the test voltage shall be disconnected during the testing.

Components and devices that have been voltage tested in accordance with their product standards may be disconnected during testing.

Loop impedance and prospective fault current

The instrument measures the impedance of the fault loop and calculates the prospective fault current. The results can be compared to limit values set on base of selected protective circuit breakers or RCDs. The measurement complies with requirements of the standard EN 61557-3.

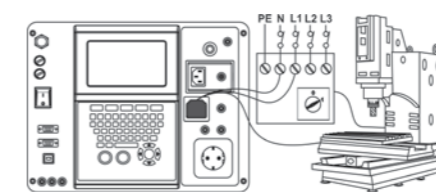

Loop impedance test

RCD testing

Various test and measurements are required for verification of RCDs in RCD protected machines. Measurements are compliant to the EN 61557-6 standard.

The following measurements and tests can be performed:

- Contact voltage,
- Trip-out time,
- Trip-out current,
- RCD autotest.

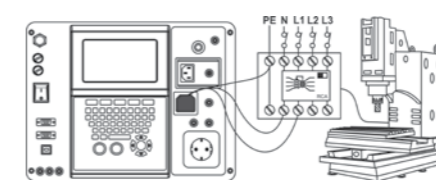

Testing of RCD in RCD protected machine

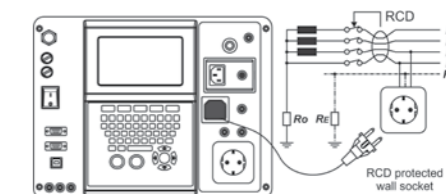

Testing of RCD in electrical installation

Discharge Time

If large capacitors in machines are disconnected from supply there is often a remaining (residual) charge on internal machine components.

Live parts having a residual voltage greater than 60 V after the supply has been disconnected, shall be discharged to 60 V or less within a time period of 5 s after disconnection of the supply.

For plugs or similar devices with exposed conductors (for example pins) if plugged out it shall be discharged to 60 V or less within a time period of 1 s after disconnection of the supply.

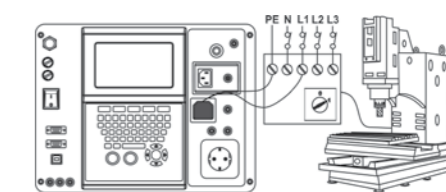

Discharge time test

Functional test

Functional check explores if the machine is working properly.

Following items should be checked while the machine is operating:

- Temperature regulators, monitors;
- RCDs and other disconnection devices;
- Operation of functional disconnecting devices;
- Operation of switches, lamps, keys;
- Rotating parts, motors, pumps;
- Power consumption, etc.

Testing the safety of machines and switchboards



CE MultiTester integrated into the automated production line.

Selection Guide for appliances, machines and switchboards testers

Part No.:	MI 2094 CE MultiTester	MI 3321 MultiServicerXA	MI 2170 MultiServicer
MEASUREMENTS			
Withstanding test 1000 V _{AC}	✓	✓	✓
Withstanding test 1890 V _{AC}	✓	✓	–
Withstanding test 2500 V _{AC}	✓	✓	✓
Withstanding test 100 ... 5000 V _{AC} (500 VA)	✓	–	–
Continuity 100 mA	✓	–	–
Continuity 200 mA	✓	✓	✓
Continuity 10 A	✓	✓	✓
Continuity 25 A	✓	–	–
Voltage drop test 10 A	✓	–	✓
Insulation resistance 250 V _{DC}	✓	✓	–
Insulation resistance 500 V _{DC}	✓	✓	✓
Insulation resistance 1000 V _{DC}	✓	–	–
Differential leakage current	✓	✓	✓
Touch leakage current	✓	✓	✓
Substitute leakage current	✓	✓	✓
Discharge time	✓	✓	✓
Leakage current measurement with optional clamp	–	✓	–
RCD, PRCD testing	–	✓	–
Line impedance	–	✓	–
Loop impedance	–	✓	–
Voltage measurement	✓	✓	✓
Frequency measurement	–	✓	–
Phase rotation indication	–	✓	–
Polarity test (IEC lead test)	–	✓	–
Functional (load) test	✓	✓	✓
ADDITIONAL FEATURES			
PASS / FAIL evaluation	✓	✓	✓
Mains supply autocheck	✓	✓	✓
Graphical LCD	✓	✓	✓
Graphical on-line help	–	✓	–
Backlight	✓	✓	–
Real time clock	✓	✓	–
QWERTY keyboard	–	✓	–
Auto testing (organizer, custom autotests)	✓	✓	–
Barcode shortcut auto testing	–	✓	–
Communication ports RS232 / USB	✓/✓	✓/✓	✓/ Option
"Test and tag" (barcode scanner + label printer)	–	✓	–
Data download to PC	✓	✓	✓
Project upload from PC to instrument	–	✓	–
Trend (compare) on instrument's LCD	–	✓	–
Trend with PC SW PATLink PRO Plus	–	✓	✓
Number of memory locations	1638	6000	62
STANDARD / OPTIONAL ACCESSORIES			
Barcode scanner	Option	Option	–
Label printer	–	Option	–
Receipt printer	–	Option	–
PC SW PATLink PRO (download, report, data export)	–	✓	✓
PC SW PATLink PRO Plus (download, PRO Plus report, data export, trend)	–	Option	Option
PC SW CE Link (download, report, autosequence editor)	Option	–	–
GENERAL DATA			
Power supply	115 V / 230 V	115 V / 230 V	230 V
Weight	13.5 kg	8.4 kg	9.5 kg
Dimensions (mm)	410 x 175 x 370	345 x 160 x 335	345 x 160 x 335

MI 2094 CE MultiTester

The MI 2094 CE MultiTester is intended for electrical safety testing and CE certification of electrical appliances, machines and switchboards during the production. It is suitable for testing the appliances after repairs and maintenance work as well. With the ability to test a multitude of different appliances the MI 2094 still remains portable, safe and easy to use. The optional PC software CE Link enables the upload of automated test sequences, downloading of test results directly to the PC, automatic data storage into a file and printing of test reports. Due to selected test functions, durable construction and accompanying PC SW package CE MultiTester is the perfect instrument for electrical safety testing in the most demanding environments like laboratories, automated production lines or specialized workshops.

MEASURING FUNCTIONS:

- Withstanding programmed voltage;
- Withstanding voltage test;
- High voltage burn-out test;
- Continuity tests;
- Insulation resistance measurement;
- Substitute leakage current;
- Differential leakage current;
- Touch leakage current;
- Discharge time;
- Functional test (power, voltage, current, $\cos \varphi$, frequency).

KEY FEATURES:

- **Auto testing:** up to 10 autosequences each composed of up to 50 steps, including pauses and comments, can be created via the optional CE Link software and saved in the memory of the instrument.
- **Withstanding voltage test:** testing of insulation with programmable test voltage up to 5 kV.
- **Burn test:** instrument performs insulation breakdown test with limited breakdown current.
- **Continuity testing:** wide selection of test currents (100 mA, 200 mA, 10 A, 25 A).
- **Easy to use:** rotary switch makes the selection of a single test simple and easy while the programmable autosequence testing prevent the risk of missing a test.
- **Portable:** due to lightweight design and rugged carrying case with handle CE MultiTester can be moved between locations.
- **Safe:** high quality accessories and optional safety devices like remote control pedal and warning lamp ensure the most safe performance of the measurements.
- **Rack mount:** due to the autotest facility and EXT / DOOR remote control of the instrument CE MultiTester can be integrated into the automated production line for output check of manufactured products.



- **Multi-system testing:** the instrument can be used on TT, TN, IT and 115 V supply systems.
- **Downloadable:** the optional PC SW CE Link enables the upload of test sequences, downloading of test results directly to the PC, automatic data storage into a file and printing of test reports.

APPLICATION:

- Portable appliances, switchgears, machines safety testing;
- Testing and verifying of manufactured products according to European Safety legislation;

- Testing of electrical appliances after repairs and maintenance work.

STANDARDS:

Functionality:

EN 61557; EN 60204-1; EN 60335-1; EN 60439-1; EN 60598-1; IEC 60745; IEC 60755; EN 61010-1; IEC 60950; IEC 61029; IEC 61558-1; EN 60065; VDE 701 T1; VDE 702 T1

Safety: IEC 61010-1

Electromagnetic compatibility:
EN 61326

TECHNICAL SPECIFICATION:

Function	Measuring range	Resolution	Accuracy
Withstanding test (PROG.HV and HV)			
- Test voltage (AC)	0.100 kV ... 0.999 kV 1.000 kV ... 5.000 kV	0.001 kV 0.001 kV	±(2 % of reading + 5 digits) ±(3 % of reading + 5 digits)
- Test current	0.0 mA ... 500.0 mA	0.1 mA	±(5 % of reading + 5 digits)
PE continuity			
- Test current 10 A and 25 A	0.000 Ω ... 0.999 Ω 1.000 Ω ... 2.000 Ω 2.001 Ω ... 9.999 Ω	0.001 Ω 0.001 Ω 0.001 Ω	±(3 % of reading + 3 digits) ±(3 % of reading + 10 digits) Indicator only
- Test current 100 mA	0.00 Ω ... 9.99 Ω 10.0 Ω ... 100.0 Ω	0.01 Ω 0.1 Ω	±(5 % of reading + 12 digits) ±(5 % of reading + 6 digits)
- Test current 200 mA	0.00 Ω ... 9.99 Ω 10.0 Ω ... 100.0 Ω	0.01 Ω 0.1 Ω	±(5 % of reading + 6 digits) ±(5 % of reading + 6 digits)
Insulation resistance	0.000 MΩ ... 1.999 MΩ 2.000 MΩ ... 199.9 MΩ 200 MΩ ... 999 MΩ	0.001 MΩ 0.001 MΩ, 0.01 MΩ, 0.1 MΩ 1 MΩ	±(5 % of reading + 10 digits) ±(3 % of reading + 3 digits) ±(10 % of reading + 10 digits)
Differential leakage current	0.00 mA ... 3.99 mA 4.0 mA ... 20.0 mA	0.01 mA 0.1 mA	±(5 % of reading + 3 digits) ±(5 % of reading + 3 digits)
Substitute leakage current	0.00 mA ... 20.00 mA	0.01 mA	±(5 % of reading + 3 digits)
Touch leakage current	0.00 mA ... 2.00 mA	0.01 mA	±(5 % of reading + 3 digits)
Functional test			
- Active and apparent power (W or VA)	0.0 ... 199.9 200 ... 3500	0.1 1	±(5 % of reading + 10 digits) ±(5 % of reading + 3 digits)
- Voltage	0 V ... 400 V	1 V	±(2 % of reading + 2 digits)
- Test current	0.000 A ... 0.999 A 1.00 A ... 15.99 A	0.001 A 0.01 A	±(3 % of reading + 5 digits) ±(5 % of reading + 5 digits)
- $\cos \varphi$	0.00 ... 1.00	0.01	±(3 % of reading + 3 digits)
- Frequency	45.00 Hz ... 65.00 Hz	0.01 Hz	±(0.1 % of reading + 3 digits)
Discharge time	0 s ... 10 s	0.1 s	±(2 % of reading + 0.2 s)
Power supply	115 V / 230 V, 50 Hz / 60 Hz		
Overtoltage category	CAT III / 300 V; CAT II / 600 V		
Protection class	I		
COM port	RS232 and USB		
Dimensions	410 x 175 x 370 mm		
Weight	13.5 kg		

STANDARD SET:

MI 2094

- Instrument CE MultiTester
- HV test pistol with 2 m cable, 2 pcs
- Continuity test lead, 2.5 m, 2 pcs
- Insulation test lead, red, 2.5 m
- Insulation test lead, black, 2.5 m
- Crocodile clip, black, 3 pcs
- Crocodile clip, red, 2 pcs
- Discharge time cable
- Mains cable

- Bag for accessories
- Instruction manual
- Calibration certificate



MI 3321 MultiServicerXA

Multifunctional portable test instrument MI 3321 MultiServicerXA is intended to perform all necessary measurements for testing the electrical safety of portable electrical equipment, machines and switchgears. It is the first machine tester covering all necessary tests according to new IEC/EN 60204 ed.5 including Loop impedance, RCD and HV tests. MultiServicerXA enables measurement of discharge time, power and current consumption and resistance to excessive voltages which are the main parameters in the safety testing of hard wired appliances and large machinery. With an easy to use user interface, large graphic LCD, QWERTY keyboard, help menus with connection diagrams and extra ports for testing fixed installations the MI 3321 is the best solution for safety testing.

MEASURING FUNCTIONS:

- Continuity tests (200 mA, 10 A);
- Insulation resistance;
- Withstanding voltage tests (1000 V, 1890 V, 2500 V);
- Substitute leakage current;
- Differential leakage current;
- Touch leakage current;
- IEC cord polarity test;
- Leakage and load TRMS current measurement with current clamp;
- Portable RCD testing;
- RCD testing;
- Line and loop impedance;
- High resolution line / loop impedance (m Ω);
- Discharge time;
- Three phase voltage / rotary field;
- Functional test.

KEY FEATURES:

- **3 in 1:** instrument performs testing of portable appliances (acc. to VDE 0701 0702), machines (acc. to IEC/EN 60204 Ed.5) and switchgears (acc. to IEC/EN 60439 and the new IEC 61439) including functional and leakage tests for DUTs with nominal power up to 3.5 kW.
- **Multi-tasking:** up to 18 different measurements can be performed either as a single test or pre-programmed test sequences (PAT mode).
- **Automated:** automatic testing and PASS / FAIL evaluation of test results according to appropriate standard.
- **Project uploading:** previous test data can be uploaded for fast retesting of the object.
- **Scan and test:** optional barcoding system and PASS / FAIL barcode label printing make retesting quick and simple.
- **RFID:** support for advanced RFID identification system.
- **User friendly:** large LCD screen, full QWERTY keyboard, help screens and warnings make the instrument an extremely easy to use.
- **Fixed appliance tests:** ports, leads and optional accessories fully support the testing of fixed machines and appliances while normal socket supports plug-in machines and appliances testing.
- **RCD testing:** instrument enables testing of parameters of RCDs and portable RCDs.



- **Clamp leakage current measurement:** quick measurement of leakage current with current clamps directly on power supply cable without disconnection of appliance from mains.
- **Discharge time test:** testing of how long it takes for the machine discharge after power is removed.
- **Withstanding voltage test:** instrument performs 2500 V_{AC}, 1890 V_{AC} and 1000 V_{AC} withstanding voltage tests with settable current limit.
- **Trend functionality:** test results can be uploaded from PC to the instrument for comparison between old and new test results on site.
- **Downloadable:** up to 6000 test results with measuring parameters can be stored in two level memory and downloaded to the PC with the help of PC SW PATLink PRO.
- **PC SW PATLink PRO** included in the standard set enables downloading, viewing, printing of test results and exporting of data to spreadsheet applications.
- **PC SW PATLink PRO Plus** enables ad-

vanced analysis of test results, upload of structures and data upload to the instrument for on site comparison of old and new results, upload of pre-programmed custom autosequences and creation of professional test reports.

APPLICATION:

- Factory machinery safety testing;
- Industrial safety testing;
- Portable appliances safety testing;
- Switchgear safety testing.

STANDARDS:

Functionality: IEC/EN 61557; IEC 60439-1; EN 60204; IEC/EN 60204-1 Ed.5; IEC/EN 60439; IEC 60755; IEC 60598-1; VDE 0404; VDE 0701-0702
Electromagnetic compatibility: EN 61326
Safety: EN 61010-1; EN 61010-031

TECHNICAL SPECIFICATION:

Function	Measuring range	Resolution	Accuracy
Withstanding test with 1890 V_{AC} and 2500 V_{AC}:			
- Test voltage	0 V ... 3000 V	1 V	±(5 % of reading + 5 digits)
- Current	0.0 mA ... 99.9 mA	0.1 mA	±(10 % of reading + 8 digits)
Withstanding test with 1000 V_{AC}:			
- Test voltage	0 V ... 1500 V	1 V	±(5 % of reading + 5 digits)
- Current	0.0 mA ... 199.9 mA 200 mA ... 500 mA	0.1 mA 1 mA	±(5 % of reading + 5 digits) ±(5 % of reading + 5 digits)
Insulation resistance with 250 V _{DC} ; 500 V _{DC}	0.000 M Ω ... 0.500 M Ω 0.501 M Ω ... 1.999 M Ω 2.00 M Ω ... 19.99 M Ω 20.0 M Ω ... 199.9 M Ω	0.001 M Ω 0.001 M Ω 0.01 M Ω 0.1 M Ω	±(10 % of reading + 5 digits) ±(5 % of reading + 3 digits) ±(5 % of reading + 3 digits) ±(5 % of reading + 3 digits)
Insulation - S resistance with 250 V _{DC} ; 500 V _{DC}	0.000 M Ω ... 0.500 M Ω 0.501 M Ω ... 1.999 M Ω 2.00 M Ω ... 19.99 M Ω	0.001 M Ω 0.001 M Ω 0.01 M Ω	±(10 % of reading + 5 digits) ±(5 % of reading + 3 digits) ±(5 % of reading + 3 digits)
PE continuity with 10 A (PAT)	0.00 Ω ... 1.99 Ω	0.01 Ω	±(5 % of reading + 3 digits)
PE continuity with 10 A (other)	0.000 Ω ... 0.999 Ω 1.00 Ω ... 1.99 Ω	0.001 Ω 0.01 Ω	±(5 % of reading + 6 digits) ±(5 % of reading + 3 digits)
PE continuity with 200 mA	0.00 Ω ... 1.99 Ω	0.01 Ω	±(5 % of reading + 3 digits)
Discharge time	0.0 s ... 9.9 s	0.1 s	±(5 % of reading + 3 digits)
Differential leakage current	0.00 mA ... 9.99 mA	0.01 mA	±(5 % of reading + 5 digits)
Substitute leakage current	0.00 mA ... 19.99 mA	0.01 mA	±(5 % of reading + 5 digits)
Touch leakage current	0.00 mA ... 2.50 mA	0.01 mA	±(10 % of reading + 5 digits)
Functional test	0.00 kVA ... 4.00 kVA	0.01 kVA	±(5 % of reading + 3 digits)
TRMS current with clamp	0.00 mA ... 9.99 mA 10.0 mA ... 99.9 mA 100 mA ... 999 mA 1.00 A ... 9.99 A 10.0 A ... 24.9 A	0.01 mA 0.1 mA 1 mA 0.01 A 0.1 A	±(5 % of reading + 10 digits) ±(5 % of reading + 5 digits) ±(5 % of reading + 5 digits) ±(5 % of reading + 5 digits) ±(5 % of reading + 5 digits)
PRCD testing	I _{AN} : 10, 15, 30 mA		
- Trip-out time	0 ms ... 300 ms (1/2xI _{AN}) 0 ms ... 300 ms (I _{AN}) 0 ms ... 40 ms (5xI _{AN})	1 ms 1 ms 1 ms	±3 ms ±3 ms ±3 ms
RCD testing	I _{AN} : 10, 30, 100, 300, 500, 1000 mA		
- Contact voltage	0.0 V ... 19.9 V 20.0 V ... 99.9 V	0.1 V 0.1 V	(-0 %/+15 %) of reading ±10 dig. (-0 %/+15 %) of reading
- Trip-out time	0.0 ms ... 40.0 ms 0.0 ms ... 300.0 ms	0.1 ms 0.1 ms	±1 ms ±3 ms
- Trip-out current	0.2xI _{AN} ... 1.1xI _{AN} (AC type) 0.2xI _{AN} ... 1.5xI _{AN} (A type, I _{AN} ≥30 mA) 0.2xI _{AN} ... 2.2xI _{AN} (A type, I _{AN} <30 mA)	0.05xI _{AN} 0.05xI _{AN} 0.05xI _{AN}	±0.1xI _{AN} ±0.1xI _{AN} ±0.1xI _{AN}
Fault loop impedance / Line impedance	0.00 Ω ... 9.99 Ω 10.0 Ω ... 99.9 Ω 100 Ω ... 1999 Ω	0.01 Ω 0.1 Ω 1 Ω	±(5 % of reading + 5 digits) ±(5 % of reading + 5 digits) ±10 % of reading
Voltage	0 V ... 550 V	1 V	±(2 % of reading + 2 digits)
Frequency	14.0 Hz ... 499.9 Hz	0.1 Hz	±(0.2 % of reading + 1 digit)
Power supply	115 V / 230 V, 50 Hz / 60 Hz		
Overvoltage category	CAT II / 300 V		
Protection class	I		
COM port	RS232 and USB		
Dimensions	345 x 160 x 335 mm		
Weight	8.4 kg		

STANDARD SET:

- MI 3321**
- Instrument MultiServicerXA
 - HV test lead
 - Plug test cable
 - 3-wire test lead
 - Test lead, black, 1.5 m
 - Test lead, red, 1.5 m
 - Test lead, red, 4 m
 - Test lead, green, 1.5 m
 - Test probe, 4 pcs (black, red, green, blue)

- Crocodile clip, black, 3 pcs
- Protective bag for accessories
- PC SW PATLink PRO with RS232 and USB cable
- Instruction manual
- Calibration certificate



MI 2170 MultiServicer

The MI 2170 MultiServicer is a multifunctional portable test instrument intended for performing all necessary measurements for testing the electrical safety of machines, switchgears and portable electrical appliances. Apart from insulation resistance, leakage currents and continuity measurements, MultiServicer enables measurement of discharge time, current consumption and resistance to excessive voltages which are the main parameters in the safety testing of hard wired appliances and large machinery. MultiServicer is placed into robust waterproof case for use in harsh industrial environments. Quick reference guide for testing, large LCD screen, user friendly interface and rotary function selector make the safety testing with MultiServicer quick and simple.

MEASURING FUNCTIONS:

- Insulation resistance;
- Withstanding voltage tests (1000 V, 2500 V);
- Continuity tests (200 mA, 10 A);
- Voltage drop;
- Substitute leakage current;
- Differential leakage current;
- Touch leakage current;
- Discharge time;
- Functional test.

KEY FEATURES:

- **3 in 1:** instrument performs testing of portable appliances, machines and switchgears including functional and leakage tests for DUTs with nominal power up to 3.5 kW.
- **Easy to use:** instrument connection guide on lid and rotating function selector make the MI 2170 an extremely easy to use.
- **PASS / FAIL:** configurable limits enable evaluation of test results according to appropriate standard.
- **Fixed appliance tests:** ports, leads and optional accessories fully support the testing of fixed machines and appliances while normal socket supports plug-in machines and appliances testing.
- **Discharge time test:** testing of how long it takes for the machine discharge after power is removed.
- **Withstanding voltage test:** instrument performs 2500 V_{AC} and 1000 V_{AC} withstanding voltage tests with settable current limit.
- **Downloadable:** test results can be stored in two level memory structure.
- **PC SW PATLink PRO** included in the standard set enables downloading, viewing, printing of test results and exporting of data to spreadsheet applications.



- **PC SW PATLink PRO Plus** enables advanced analysis of test results and creation of professional test reports.

APPLICATION:

- Factory machinery safety testing;
- Industrial safety testing;
- Portable appliances safety testing;
- Switchgear safety testing.

STANDARDS:

Functionality:
IEC 60204; IEC 60439-1; VDE 701;
VDE 702; IEC 60598-1; IEC 60755;
IEC 50144-1

Electromagnetic compatibility:
EN 50081-1;
EN 61000-6-1

Safety:
EN 61010-1

TECHNICAL SPECIFICATION:

Function	Measuring range	Resolution	Accuracy
Withstanding test with 2500 V_{AC}:			
- Test voltage	0.00 kV ... 3.00 kV	0.01 kV	±(5 % of reading + 5 digits)
- Current	0.0 mA ... 99.9 mA	0.1 mA	±(5 % of reading + 5 digits)
Withstanding test with 1000 V_{AC}:			
- Test voltage	0.00 kV ... 1.50 kV	0.01 kV	±(5 % of reading + 5 digits)
- Current	0.0 mA ... 109.9 mA 110 mA ... 500 mA	0.1 mA 1 mA	±(5 % of reading + 5 digits) ±(5 % of reading + 5 digits)
Insulation resistance measurement with 500 V _{DC}	0.00 MΩ ... 19.99 MΩ	0.01 MΩ	±(5 % of reading + 5 digits)
Voltage drop	0.00 V ... 11.99 V	0.01 V	±(5 % of reading + 5 digits)
PE continuity with 200 mA	0.00 Ω ... 19.99 Ω	0.01 Ω	±(5 % of reading + 5 digits)
PE continuity with 10 A	0.000 Ω ... 1.999 Ω	0.001 Ω	±(5 % of reading + 5 digits)
PE continuity with 200 mA	0.00 Ω ... 19.99 Ω	0.01 Ω	±(5 % of reading + 5 digits)
Discharge time	0.0 s ... 9.9 s	0.1 s	±(5 % of reading + 3 digits)
Differential leakage current	0.00 mA ... 19.99 mA	0.01 mA	±(5 % of reading + 5 digits)
Substitute leakage current	0.00 mA ... 19.99 mA	0.01 mA	±(5 % of reading + 5 digits)
Touch leakage current	0.00 mA ... 1.99 mA	0.01 mA	±(5 % of reading + 5 digits)
Functional test; current	0.00 A ... 15.99 A	0.01 A	±(5 % of reading + 3 digits)
Power supply	230 V, 50 Hz		
Overvoltage category	CAT III / 300 V		
Protection class	I		
COM port	RS232		
Dimensions	345 x 160 x 335 mm		
Weight	9.5 kg		

STANDARD SET:

- **MI 2170**
- Instrument MultiServicer
- HV test lead
- Test lead, black, 2 m
- Test lead, red, 2 m
- Test probe, black
- Test probe, red
- Crocodile clip, black
- Crocodile clip, red
- PC SW PATLink PRO with RS232 cable

- Protective bag for accessories
- Instruction manual
- Calibration certificate



PATLink PRO and PATLink PRO Plus

PC software PATLink PRO is an advanced, user friendly software package designed with the portable appliance testing engineer in mind. The graphical interface with drag and drop data relocation, data filtering, data archiving functions and automatic report generation allows a variety of users with a range of different skills and abilities to create professional reports which include company logos. The PATLink PRO Plus software introduces extra features including the ability to reload data onto Metrel uploadable / downloadable testers, perform trend analysis on equipment and introduces PRO Plus certificates and individual appliance reports.

KEY FEATURES:

Full data filtering: All data can be filtered by different parameters: Retest Date, Test Date, Project, User, etc.

Tree style or table style: Data can be represented in tree or table view.

Drag and drop: The elements of the structure can be relocated and renamed.

Customer database: It allows test engineer to create his own database of customers fully equipped with all appropriate data.

Company logo loading: Load company logos into the software so that they can be printed on test reports.

Data backup: All downloaded data can be backed up to prevent the loss of valuable data for example in case of hard disk failure.

Appliance information editing: Allows you to edit data, e.g. to set up Retest Date, Repair Code, add Comments, etc.

Export of test results: Data of selected appliances together with test results can be exported to other programs (MS Excel, MS Word).

PDF report: Test Report can be transformed into PDF format.

Full built-in help files: Integrated help menu contains detailed explanation of PC SW handling.

Automatic self-test record keeping: Results of the CHECKBOX function (MI 3311 only) can be automatically transferred to the PC and printed onto the test reports.

"Plug & Play": When meter is connected to the PC it is automatically recognized by the software.

Upload data back to PAT tester: User can upload test results from the previous measurement session (e.g. from last year) so the same tests can be simply repeated and results of both measurements can be compared (MI 3321, MI 3305, MI 3304, MI 3310 25A, MI 3310).

Autosequences upload: Test autosequences can be prepared via PATLink PRO and then sent to the tester (MI 3321, MI 3305, MI 3304, MI 3310 25A, MI 3310, MI 3309, MI 3311) for testing speedup.

Structures upload: The structure of test site can be created in advance on the PC and then simply uploaded to the tester

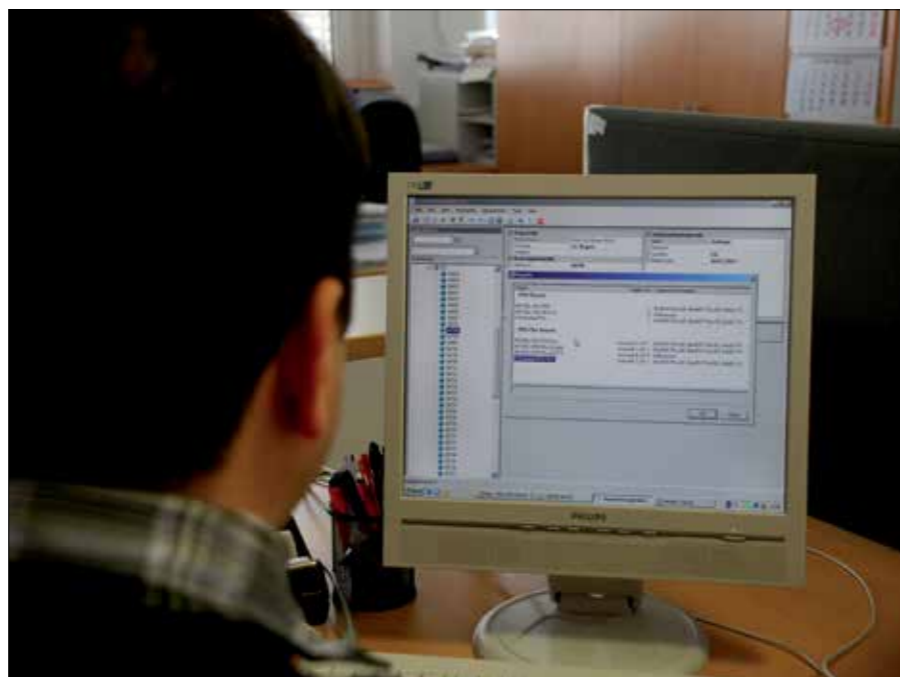

(MI 3321, MI 3305, MI 3304, MI 3310 25A, MI 3310); if needed any deviations can be adjusted on the tester on site.

Trend analysis: Enables to compare test results of the last and previous tests.

Automatic PRO report generation: Enables automatic generation of Test Report (standard or full detailed).

PATLink PRO Plus professional reports: The PRO Plus report displays results as the PRO version but enables editing the information before printing the report.

PC SW PATLink PRO / PRO Plus is compatible with:

- MI 3321 MultiservicerXA
- MI 2170 Multiservicer
- MI 3305 OmegaPAT Plus
- MI 3304 BetaPAT Plus
- MI 3310 / MI 3310 25A SigmaGT
- MI 3309 BT Delta GT
- MI 3311 GammaGT

The following Certificates for PRO version are available:

- Full detailed PRO Electrical equipment test report;
- METREL PAT PRO Electrical equip-

ment test report.

The following Certificates for PRO Plus version are available:

- METREL PRO Plus (Single) Electrical equipment test report;
- METREL Full detailed PRO Electrical equipment test report;
- METREL PAT PRO Plus Electrical equipment test report.

PASSWORD PROTECTION:

PC SW PATLink PRO is password protected for the following instrument:

- MI 3311
- PC SW PATLink PRO Plus is password protected for all Metrel PAT testers.

ORDERING INFORMATION:

- **A 1305** PC SW PATLink PRO with USB and RS232-PS/2 cable
- **A 1306** PC SW PATLink PRO Plus with USB and RS232-PS/2 cable
- **A 1203** Upgrade code PATLink PRO to PATLink PRO Plus

Full detailed PRO Report

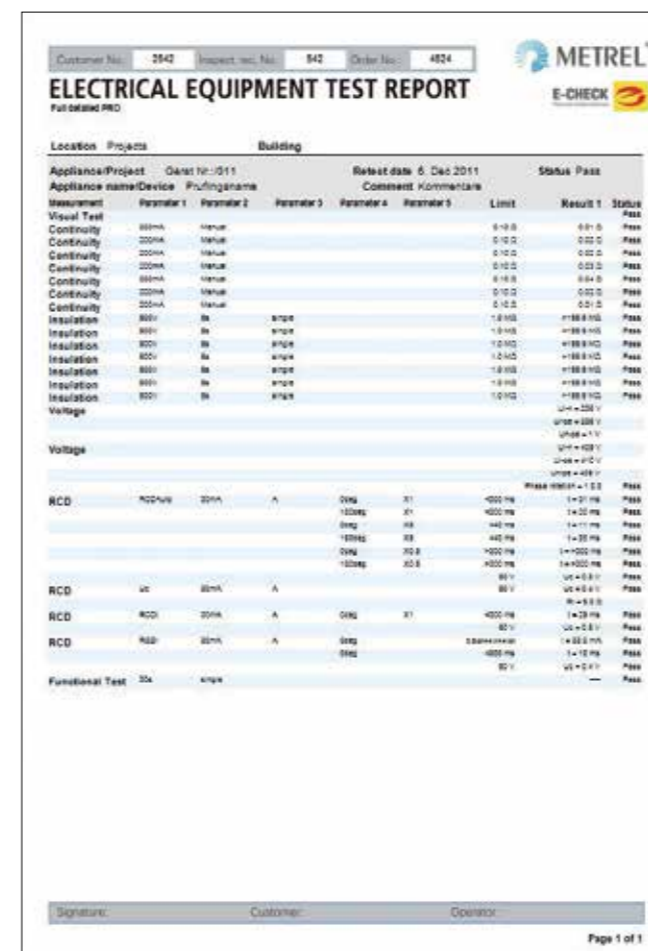

Full detailed PRO Plus Report



Trend analysis (comparison of results from tests performed in different time period)

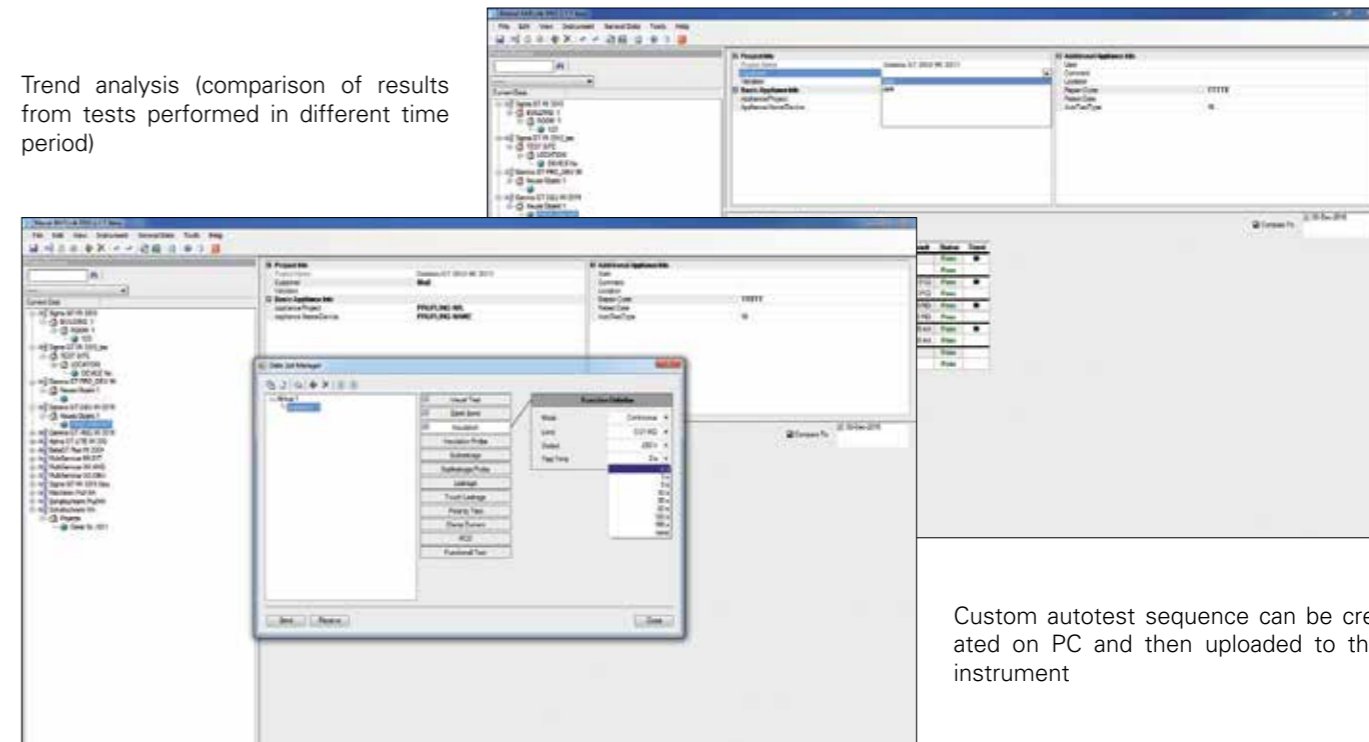

Custom autotest sequence can be created on PC and then uploaded to the instrument

A 1433 PATLink Android

The PATLink Android is a powerful tool. It enables fast and simple data management of tested appliances, as well as a quick overview of already performed tests by simply scanning a QR code. The Application enables the user to enter and save data to the test instrument by using a Smart phones' keyboard. Also it enables a creation of the custom made database for portable appliances' ID's, the appliances's names and the appliances' locations. All these features enable the user a faster and easier data handling.

PATLink Android enables the user to scan the QR codes which contain information of the previous results, the test status, and the previously used test sequence. Based on this information the user can start the retest of the appliance with a single press on the Android Application.

KEY FEATURES:

- On - site comparison of the test results;
- Creation of the custom database;
- Use of Smart phones camera for the QR and Barcode scanning;
- Use of Smart Phones virtual keyboard.

ADDITIONAL FEATURES:

- In Built Risk Assessment tool to provide correct Re-Test periods in accordance with COP version 4;
- Protect your business by applying QR codes instead of Bar Codes.

PATLink Android is compatible with:

- MI 3309 BT DeltaPAT
- MI 3310 25A SigmaPAT (HW3)
- MI 3311 GammaPAT (supported by BT dongle)

Supported by
BT dongle



Built-in BT
solution

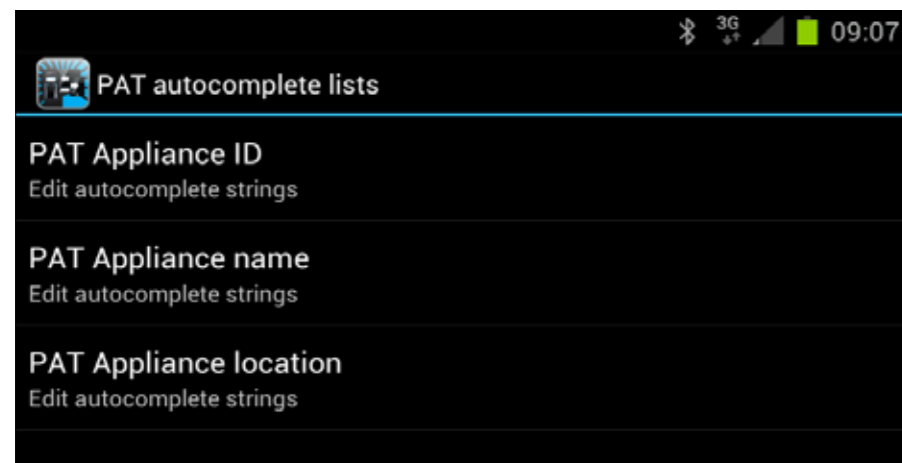

A 1434 aPATLink Android

The aPATLink Android is Advanced Portable Appliance Testing tool. It enables fast and simple data management of tested appliances, as well as a quick overview of already performed tests by simply scanning a QR code. The Application enables the user to send results to the main office before leaving test site, enter and save data to the test instrument by using a Smart phones' keyboard. Also it enables a creation of the custom made database for portable appliances' ID's, the appliances's names and the appliances' locations. All these features enable the user a faster and easier data handling.

KEY FEATURES:

- Complete database of tested appliances on one location;
- Upcoming retest warning on your smart phone or tablet;
- Simple, custom auto-test creation (MI 3309 DeltaPAT);
- Use of smart phones barcode or QR code scanner for quicker data entry;
- Remote control of PAT tester;
- Easy data entering;
- Projects can be stored to your drop box account;
- Sending data to main office, before leaving test site;
- Built in risk assessment calculator;
- None skilled user can perform test simply by scanning the QR code containing all needed information for specific appliance;
- Overview of testing parameters by simple scanning QR code.

ADDITIONAL FEATURES:

- In Built Risk Assessment tool to provide correct Re-Test periods in accordance with COP version 4;
- Protect your business by applying QR codes instead of Bar Codes.

aPATLink Android is compatible with:

- MI 3309 BT DeltaPAT
- MI 3310 25A SigmaPAT (HW3)
- MI 3311 GammaPAT (supported by BT dongle)

Supported by
BT dongle



Built-in BT
solution

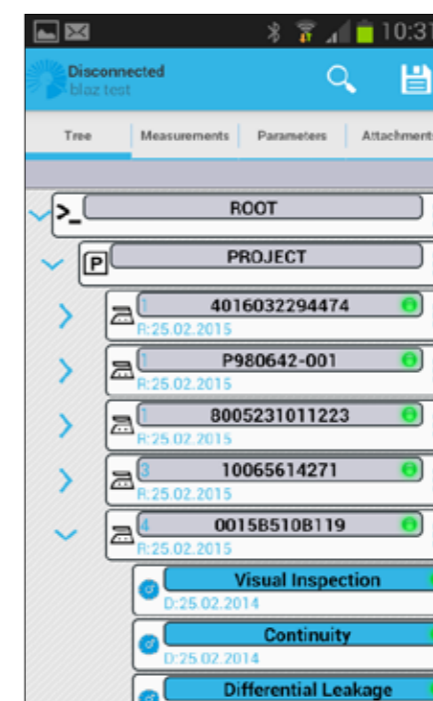
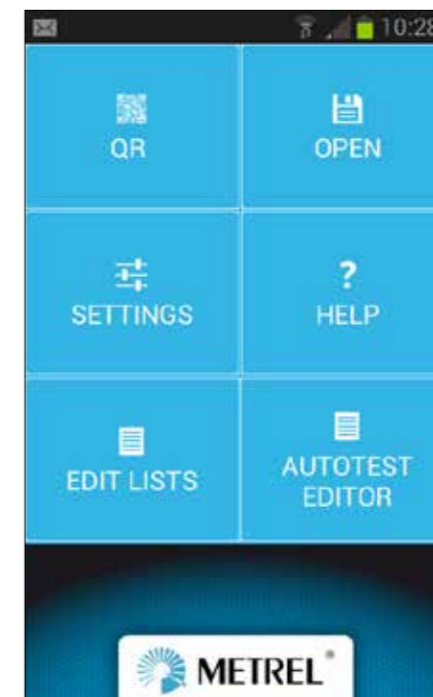

Selection Guide for PAT Accessories

Photo	Part number	Description	Target application	MI 3305	MI 3304	MI 3310 25A	MI 3310	MI 3309 BT	MI 3311	MI 2142	A 1322	A 1422	MI 2094	MI 3321	MI 2170
	A 1143	Euro Z 290 A	Euro Z 290 A is the impedance tester which enables line / loop impedance measurements with an accuracy down to 0.1 mΩ.	-	-	-	-	-	-	-	-	-	✓	-	-
	A 1322	Active 3-phas Adapter	A 1322 Multifunctional test adapter is designed for troubleshooting, as well as for periodic testing on 3-phase appliances and machinery.	-	-	✓	✓	-	-	-	-	-	✓	-	-
	A 1422	Active 3-phas Adapter Plus	A 1422 Multifunctional test adapter is designed for troubleshooting, as well as for periodic testing on 3-phase appliances, machinery, and ARC welding equipment.	-	-	✓	✓	-	-	-	-	-	✓	-	-
	A 1207	Three phase adapter	The 3-phase adapter for substitute leakage current, insulation resistance and continuity measurements on electric loads equipped with 16A and 32A CEE 3P sockets.	✓	✓	✓	✓	✓	✓	✓	-	-	✓	✓	✓
	A 1316	3-phase adapter (16 A CEE-Schuko)	3-phase adapter for testing 3-phase appliances.	✓	✓	✓	✓	✓	✓	✓	-	-	✓	✓	✓
	A 1317	3-phase adapter (32 A CEE-Schuko)	3-phase adapter for testing 3-phase appliances.	✓	✓	✓	✓	✓	✓	✓	-	-	✓	✓	✓
	A 1110	Three phase adapter	3-phase test adapter for installation safety testing on 3-phase sockets type 16 A 3CEE.	-	-	-	-	-	-	-	-	-	✓	-	-
	A 1111 A 1215 (for MI 2150)	Three phase adapter with switch	3-phase adapter with selection switch for installation safety testing on 3-phase sockets type 16 A 3CEE. The adapter allows seamless switching between measurements.	-	-	-	-	-	-	-	-	-	✓	-	-
	A 1373	3-phase mains cable / adapter 32 A male / 32 A female, 5 pin, 2 m	3-phase test adapter, for testing of 3 phase extension leads in combination with A 1322 / Active 3-phase Adapter. 3-phase power supply cable for A 1322 / Active 3-phase adapter.	-	-	-	-	-	-	-	✓	✓	-	-	-
	A 1375	1-phase mains cable / adapter 32 A / 16 A Schuko, 3 pin, 2 m	1-phase Power supply cable for A 1322 / Active 3-phase adapter.	-	-	-	-	-	-	-	✓	✓	-	-	-
	A 1376	3-phase adapter 16 A male / 16 A female, 5 pin, 2 m	3-phase test adapter, for testing of 3 phase extension leads in combination with A 1322 / Active 3-phase Adapter.	-	-	-	-	-	-	-	✓	✓	-	-	-
	A 1394	1-phase adapter 16 A male / 16 A female, 3 pin, 2 m	1-phase test adapter for, testing of 1 phase extension leads in combination with A 1322 / Active 3-phase Adapter.	-	-	-	-	-	-	-	✓	✓	-	-	-

✓ Option - Not available

Selection Guide for PAT Accessories

Photo	Part number	Description	Target application	MI 3305	MI 3304	MI 3310 25A	MI 3310	MI 3309 BT	MI 3311	MI 2142	A 1322	A 1422	MI 2094	MI 3321	MI 2170
	A 1418	1-phase adapter 16 A, 3 pin female / 16 A Schuko male, 2 m	1-phase test adapter for, testing of 1 phase extension leads in combination with A 1322 / Active 3-phase Adapter.	-	-	-	-	-	-	-	✓	✓	-	-	-
	A 1419	1-phase adapter 16 A, 3 pin male / 16 A Schuko female, 2 m	1-phase test adapter for, testing of 1 phase extension leads in combination with A 1322 / Active 3-phase Adapter.	-	-	-	-	-	-	-	✓	✓	-	-	-
	A 1423	Adapter for welding equipment, Ø14/CX20	Test adapter for measuring leakage current, insulation, earth bond and no load voltage on ARC welding equipment.	-	-	-	-	-	-	-	-	✓	-	-	-
	A 1424	Adapter for welding equipment, Ø21/CX22	Test adapter for measuring leakage current, insulation, earth bond and no load voltage on ARC welding equipment.	-	-	-	-	-	-	-	-	✓	-	-	-
	A 1425	Adapter for welding equipment, Ø21/CX25	Test adapter for measuring leakage current, insulation, earth bond and no load voltage on ARC welding equipment.	-	-	-	-	-	-	-	-	✓	-	-	-
	A 1283	Shielded leakage current clamp	Current clamp with high resolution for accurate leakage current measurements.	✓	✓	✓	✓	-	-	-	-	-	-	✓	-
	A 1472	Leakage current clamp	Current clamp with high resolution for accurate leakage current measurements.	-	-	-	-	✓	-	-	-	-	-	-	-
	A 1018	Current clamp (low range, leakage)	High accuracy current clamp 1000 A / 1 A with jaw opening 52 mm and fixed 1.5 m cable for both load and low range / leakage current measurement and for earth resistance measurement as well.	-	-	-	-	-	-	✓	-	-	-	-	-
	A 1388	Adapter Schuko / Schuko	Measuring adapter for leakage current measurements: for measuring differential leakage current, protective conductor current, neutral current and load current, through leakage current clamp. All wires are separated.	✓	✓	✓	✓	-	-	-	-	-	-	✓	-
	A 1389	Adapter CEE 5-P 16A / CEE 5-P 16A	Measuring adapter for leakage current measurements: for measuring differential leakage current, protective conductor current, neutral current and load current, through leakage current clamp. All wires are separated.	✓	✓	✓	✓	-	-	-	-	-	-	✓	-
	A 1390	Adapter CEE 5-P 32A / CEE 5-P 32A	Measuring adapter for leakage current measurements: for measuring differential leakage current, protective conductor current, neutral current and load current, through leakage current clamp. All wires are separated.	✓	✓	✓	✓	-	-	-	-	-	-	✓	-
	A 0941	Remote control pedal	Remote control pedal is used for safe remote start of high voltage insulation test and additionally allows free hand operation of the worker.	-	-	-	-	-	-	-	-	-	✓	-	-

✓ Option - Not available

Selection Guide for PAT Accessories

Photo	Part number	Description	Target application	MI 3305	MI 3304	MI 3310 25A	MI 3310	MI 3309 BT	MI 3311	MI 2142	A 1322	A 1422	MI 2094	MI 3321	MI 2170
	A 0942	Warning lamp	Warning lamps visually signalizes ongoing HV insulation test and warns the user about dangerous voltage conditions.	-	-	-	-	-	-	-	-	-	✓	-	-
	A 1421	External buzzer	Acoustics signal for auto-continuity measurement.	-	-	-	-	-	-	-	-	-	✓	-	-
	A 1059	Insulation and Continuity adapter	1-phase 16 A CEE plug adapter for insulation resistance and continuity measurements.	-	-	-	-	-	-	-	-	-	✓	-	-
	A 1060	Power splitter for discharge time measurement	T-type power splitter for measurements of discharge time on machinery and switchgear.	-	-	-	-	-	-	-	-	-	✓	✓	✓
	S 1057	HV test lead, 5 m, 2 pcs	High voltage extension test leads for measurements on larger electrical equipment.	-	-	-	-	-	-	-	-	-	✓	-	-
	S 1058	Continuity test lead, 2 x 10 m, 2 pcs	Extension test leads for continuity measurements.	-	-	-	-	-	-	-	-	-	✓	-	-
	S 1072	Continuity test lead with crocodile clip, 2 x 2.5 m, 2 pcs	Extension test leads with protection shield and with crocodile clips for continuity testing with high test currents (10 A, 25 A).	-	-	-	-	-	-	-	-	-	✓	-	-
	S 2012	Continuity test lead, 10 m, 2 pcs (red, black)	2 pieces of extension test lead for continuity measurements.	-	-	-	-	-	-	-	-	-	✓	✓	✓
	S 2025	Test lead, 1.5 m, 2 pcs (black, red)	Connection leads for different measurements.	-	-	-	-	-	-	-	-	-	✓	✓	✓
	A 1095	Insulation / Subleakage adapter	The adapter equipped with CEE 16 A schuko plug supports insulation resistance and touch leakage current measurements on Class 1 portable appliances with conductive metal parts.	-	-	-	-	-	-	-	-	-	-	-	✓
	A 1096	Adapter for permanently wired loads	The adapter allows continuity and insulation resistance measurement on permanently wired loads (without plug).	-	-	-	-	-	-	-	-	-	-	-	✓
	A 1447	PRCD Extension adapter	Adapter for testing of PRCD-S/K, supported from HW4.	-	-	-	-	-	-	-	-	-	-	✓	-

✓ Option - Not available

Selection Guide for PAT Accessories

Photo	Part number	Description	Target application	MI 3305	MI 3304	MI 3310 25A	MI 3310	MI 3309 BT	MI 3311	MI 2142	A 1322	A 1422	MI 2094	MI 3321	MI 2170
	A 1153	Test lead, black, 20 m	Extension test lead for earth and continuity measurements.	✓	✓	✓	✓	✓	✓	-	✓	✓	✓	✓	✓
	A 1154	Test lead, black, 4 m	Extension test lead for earth and continuity measurements.	✓	✓	✓	✓	✓	✓	-	✓	✓	✓	✓	✓
	A 1331	Test lead with crocodile clip, black, 1,5 m	Test lead with crocodile clip for PAT testing.	-	-	✓	✓	✓	✓	-	-	-	-	✓	-
	A 1404	Test lead with test tip, black, 1,5 m	Earth bond test lead with test tip for PAT testing.	✓	✓	-	-	-	-	✓	-	-	-	-	-
	A 1334	IEC cable, 2 m	Additional IEC cable for performing PRCD test with MI 3309.	-	-	✓	✓	✓	-	-	-	-	-	✓	-
	A 1341	Test lead, green 1.5 m	Test lead for PAT safety testing.	✓	✓	✓	✓	✓	-	-	-	-	-	✓	-
	A 1342	Test lead, brown 1.5 m	Test lead for PAT safety testing.	-	-	✓	✓	✓	-	-	-	-	-	-	-
	A 1309	Crocodile clip, green	Crocodile clip assures secure and permanent contact during the measurement on bus bars, fixing screws, etc.	✓	✓	✓	✓	✓	-	-	-	-	-	✓	-
	A 1310	Crocodile clip, blue	Crocodile clip assures secure and permanent contact during the measurement on bus bars, fixing screws, etc.	-	-	-	-	-	-	-	-	-	-	-	✓
	A 1297	Crocodile clip, brown	Crocodile clip assures secure and permanent contact during the measurement on bus bars, fixing screws, etc.	-	-	✓	✓	✓	-	-	-	-	-	-	-
	A 1013	Crocodile clip, black	Crocodile clip assures secure and permanent contact during the measurement on bus bars, fixing screws, etc.	✓	✓	✓	✓	✓	✓	✓	-	-	✓	✓	✓
	A 1064	Crocodile clip, red	Crocodile clip assures secure and permanent contact during the measurement on bus bars, fixing screws, etc.	-	-	-	-	-	-	-	-	-	-	✓	✓

✓ Option - Not available

Selection Guide for PAT Accessories

Photo	Part number	Description	Target application	MI 3305	MI 3304	MI 3310 25A	MI 3310	MI 3309 BT	MI 3311	MI 2142	A 1322	A 1422	MI 2094	MI 3321	MI 2170
	A 1062	Test probe, green	Test probe with Ø 4 mm connection is suitable for performing measurements both in mains outlets and in situations when no schuko outlet is present.	✓	✓	✓	✓	✓	-	-	-	-	-	✓	-
	A 1015	Test probe, blue	Test probe with Ø 4 mm connection is suitable for performing measurements both in mains outlets and in situations when no schuko outlet is present.	-	-	-	-	-	-	-	-	-	-	✓	-
	A 1298	Test probe, brown	Test probe with Ø 4 mm connection is suitable for performing measurements both in mains outlets and in situations when no schuko outlet is present.	-	-	✓	✓	✓	-	-	-	-	-	-	-
	A 1014	Test probe, black	Test probe with Ø 4 mm connection is suitable for performing measurements both in mains outlets and in situations when no schuko outlet is present.	✓	✓	✓	✓	✓	✓	-	-	-	✓	✓	✓
	A 1016	Test probe, red	Test probe with Ø 4 mm connection is suitable for performing measurements both in mains outlets and in situations when no schuko outlet is present.	-	-	-	-	-	-	-	-	-	-	✓	✓
	A 1268	Test probe, brush type, 4 mm	Test probe, brush type, assures good galvanic contact when measuring on revolving parts, flat surfaces, screw connections and similar. Equipped with standard 4 mm connector.	✓	✓	✓	✓	✓	✓	✓	-	-	✓	✓	✓
	A 1276	Label printer with power and data cables	Printer supports printing of identification labels containing a complete appliance information and PASS or FAIL evaluation of test results.	✓	✓	✓	✓	✓	✓	-	-	-	-	✓	-
	A 1318	Label printer (Bluetooth)	Printer supports printing of identification labels containing a complete appliance information and PASS or FAIL evaluation of test results.	-	-	✓	-	-	-	-	-	-	-	-	-
	S 2062	BT label printer set	Printer supports printing of QR codes which contain information of the previous results, the test status, and the previously used test sequence.	-	-	✓	✓	✓	✓	-	-	-	-	-	-
	A 1295	Spare label roll	Spare label rolls for printer A 1276 and A 1318.	✓	✓	✓	✓	✓	✓	-	-	-	-	✓	-
	A 1328	Hi-Q DT labels	High quality spare label rolls for printer A 1276 and A 1318.	✓	✓	✓	✓	✓	✓	-	-	-	-	✓	-
	A 1379	Paper for A 1276, A 1318 printers	Spare thermal receipt paper for printer A 1276 and A 1318.	✓	✓	✓	✓	✓	✓	-	-	-	-	✓	-

✓ Option - Not available

Selection Guide for PAT Accessories

Photo	Part number	Description	Target application	MI 3305	MI 3304	MI 3310 25A	MI 3310	MI 3309 BT	MI 3311	MI 2142	A 1322	A 1422	MI 2094	MI 3321	MI 2170
	A 1450	Spare label roll for S 2062	Spare thermal receipt paper for printer S 2062.	-	-	✓	✓	✓	✓	-	-	-	-	-	-
	A 1359	Thermal printer cleaning kit	Cleaning Kit for printers A 1276 and A 1318 which includes 25 Cleaning Cards and 25 Adhesive Removers.	✓	✓	✓	✓	✓	✓	-	-	-	-	✓	-
	A 1061	Barcode scanner	Barcode scanner for identification of barcodelabelled appliances (for MI 2094 HW1 and HW2).	-	-	-	-	-	-	-	-	-	-	✓	-
	A 1105	Barcode scanner	Barcode scanner for identification of barcodelabelled appliances.	✓	✓	✓	✓	✓	✓	✓	-	-	-	✓	✓
	A 1321	Barcode scanner (Bluetooth)	Barcode scanner for identification of barcodelabelled appliances.	-	-	✓	-	-	-	-	-	-	-	-	-
	A 1106	Barcode labels, 1000 pcs	Appliances can be marked with barcode labels for easier identification.	✓	✓	✓	✓	✓	✓	✓	-	-	-	✓	✓
	A 1107	RFID reader / writer	RFID reader / writer allows to read and upload test results and informaton about tested electrical equipment to the RFID tags.	✓	✓	✓	✓	✓	✓	✓	-	-	-	✓	-
	A 1108	RFID tags, self stick, 25 pcs RFID tags, key tag, 25 pcs	RFID tags sufficient memory space to store test results and tested appliance information.	✓	✓	✓	✓	✓	✓	✓	-	-	-	✓	-
	A 1337	RFID tags, self-stich 50 pcs	RFID tags have sufficient memory space to store test results and tested appliance information.	✓	✓	✓	✓	✓	✓	✓	-	-	-	✓	-
	A 1160	Fast charger for 8 AA batteries with a set of 6 NiMH bat., type AA	Fast battery charger for up to 8 pieces of AA rechargeable batteries, and a set of 6 pcs NiMH rechargeable batteries, type AA.	-	-	-	-	✓	✓	-	-	-	-	-	-
	A 1169	Fast charger for AA, C, D and 9 V block batteries	Fast battery charger for up to 12 pcs AA, 6 pcs C or D rechargeable batteries, 4 pcs 9 V block batteries.	-	-	✓	✓	✓	✓	-	-	-	-	-	-
	A 1017	Communication cable RS232	RS232 interface cable for connecting the instrument with the PC.	✓	✓	-	-	-	-	✓	✓	✓	✓	✓	✓

✓ Option - Not available

Selection Guide for PAT Accessories

Photo	Part number	Description	Target application	MI 3305	MI 3304	MI 3310 25A	MI 3310	MI 3309 BT	MI 3311	MI 2142	A 1322	A 1422	MI 2094	MI 3321	MI 2170
	A 1171	RS232 / USB adapter with 1 m cable	RS232 / USB adapter for instruments without USB communication port.	-	-	-	-	-	-	✓	-	-	✓	-	✓
	A 1073	PC SW CE Link with RS232 cable	PC SW CE Link is a multi-purpose software for programming of the MI 2094, test data downloading and evaluation and creation of test reports.	-	-	-	-	-	-	-	-	-	✓	-	-
	A 1203	Upgrade code PATLink PRO to PATLink PRO Plus	Password for upgrading standard PC software PATLink PRO to advanced PC SW PATLink PRO Plus with professional report creation facility.	✓	✓	✓	✓	✓	✓	✓	-	-	-	✓	✓
	A 1305	PC SW PATLink PRO with USB and RS232-PS/2 cable	PC Software PATLink PRO enables downloading, data management and printing of test reports. Comes delivered with RS232-PS/2 and USB communication cables.	✓	✓	✓	✓	✓	✓	✓	-	-	-	✓	✓
	A 1306	PC SW PATLink PRO Plus with USB and RS232-PS/2 cable	PATLink PRO Plus is an advanced PC SW which enables downloading, test results analysis, data upload to the instrument and professional test report creation. Delivered with RS232 and USB COM cables.	-	-	-	-	-	✓	✓	-	-	-	-	-
	A 1433	PATLink Android	PATLink Android enables fast and simple data management of tested appliances, as well as a quick overview of already performed tests by simply scanning a QR code.	-	-	✓	-	✓	✓	-	-	-	-	-	-
	A 1434	aPATLink Android	PATLink Android enables fast and simple data management of tested appliances, as well as a quick overview of already performed tests by simply scanning a QR code.	-	-	✓	-	✓	✓	-	-	-	-	-	-
	A 1436	Bluetooth dongle	External Bluetooth adapter for wireless connection between Metrel's instruments and Smart phones, tablets and PCs.	-	-	-	-	-	✓	-	-	-	-	-	-
	A 1271	Small soft carrying bag	Small soft carrying bag for transport and storage of test instrument or accessories.	✓	✓	✓	✓	✓	✓	✓	✓	✓	✓	✓	✓
	A 1289	Soft carrying bag	Large soft carrying bag for transport and storage of test instrument and belonging accessories.	✓	✓	✓	✓	✓	✓	✓	✓	✓	✓	✓	✓
	A 1302	Set of carrying straps	Set of carrying straps for carrying the measuring instrument around the neck allowing free hand use of the tester.	-	-	-	-	✓	✓	-	-	-	-	-	-
	A 1303	Soft hand strap	Soft hand strap for holding the instrument.	-	-	-	-	✓	✓	-	-	-	-	-	-

✓ Option - Not available

Accessories: page 3.34

MEASURING INSTRUMENTS AND TESTERS

- Electrical Installation Safety
- High Voltage Insulation / Continuity / Earth
- Appliance / Machine / Switchboard Safety
- Power Quality Analysis
- LAN Cabling Certification
- Indoor Environment Quality
- Digital Multimeters / Clamp Meters / Voltage and Continuity Testers
- Variable transformers / Equipment for laboratories and Schools

GOOD TO KNOW

Power Quality Analysis	4	-	02
Selection Guide for Power Quality Analysers	4	-	04
Selection Guide for Clamps	4	-	06
MI 2892 PowerMaster NEW	4	-	08
MI 2792A PowerQ4 Plus	4	-	10
MI 2792 PowerQ4 Plus	4	-	12
MI 2592 PowerQ4	4	-	14
MI 2392 PowerQ <i>Plus</i>	4	-	16
MI 2492 PowerQ	4	-	18
MI 2130 VoltScanner	4	-	20
PC SOFTWARE			
PowerView3	4	-	22
Selection Guide for Accessories	4	-	24

Power Quality Testing

Find out more about modern power quality measurement techniques

There are quite a few reasons for measuring and analysing power quality nowadays. Potential interactions between end use equipment and electric distribution system, external electromagnetic interferences, resonant states between electrical circuits and some other factors call for a need to be analysed in order that harmful consequences can be omitted or prevented. Power quality analysing includes measurements of:

- Phase to ground voltages;
- Phase to neutral voltages;
- Neutral to ground voltages;
- Phase to phase voltages in three-phase systems;
- Phase currents;
- Current in a neutral conductor;
- Frequency;
- Power Factor, $\cos \varphi$;
- Harmonic components of current and voltage and their direction;
- Waveform of current and voltage at specific circumstances (peak magnitude, primary frequency, time of occurrence, rising rate);
- Transients.

Active Power (P)

Active power is the power generated if a voltage is placed over a purely resistive load and current is allowed to flow. Active power is usually measured in watts (W) or kilowatts (kW).

Reactive Power (Q)

Reactive power is the power that is generated by reactive components (e.g. inductors, capacitors) to create a magnetic field. This is usually measured in Volt-Amperes reactive (VAR).

Apparent Power (S)

Apparent power is the perceived power from a load that has both resistive and reactive components. Apparent power is the vector sum of both active and reactive power and is usually measured in Volt-Amperes (VA).

Power Factor

Power factor is a measure of a power system's efficiency and is the ratio of real power to apparent power.

Energy

Energy is the generation or use of electric power over a period of time. This is usually expressed in kilowatt-hours (kWh).

Fundamental frequency

The fundamental frequency is the lowest and most predominant frequency in a power system (e.g. the fundamental frequency of the mains voltage in the EU is 50 Hz). The fundamental frequency is also called the 1st harmonic of the system.

Voltage events

Dips
Supply voltage dip represents temporary drops of the voltage under the nominal level.

Swells

Supply voltage swells are instantaneous voltage increases (opposite to dips).

Interruptions

Voltage interruption is classified as a network's isolation from any source of supply.

Unbalance

Supply voltage unbalance arises when rms values or phase angles between consecutive phases are not equal.

Harmonics

Harmonics are integer frequency multiplication of the fundamental frequency (e.g. with a fundamental of 50 Hz, the 2nd harmonic is $50 \times 2 = 100$ Hz, 3rd harmonic is $50 \times 3 = 150$ Hz). Harmonics can be caused by a variety of modern day equipment including resonating transformers, switch-mode power supplies, IT equipment, etc.

Interharmonics

Interharmonics are harmonics that are not an integer multiplication of the fundamental frequency. The main sources of interharmonic waveform distortion are static frequency converters, induction motors and arcing devices.

Total Harmonic Distortion (THD)

THD is the ratio of a wave's harmonic content (for voltage or current) to its fundamental component.

Transients

Transient is a term for short, highly damped momentary voltage or current disturbance. They usually appear as a consequence of external electromagnetic interferences (atmospheric electric discharges, switching manoeuvres).

Flickers

Flicker appears as changing illumination intensity which is a reflection of a changing voltage level.

Inrush current

As a motor begins the current needed to start the motor can be 10 to 15 times the normal operating current. This initial surge of current can cause dips in voltage and can be hard to analyse with normal test instruments, for this reason an analyser with a fast logging function is required.

Instrument connection to the LV and MV Power Systems

When connecting the instrument it is essential that both current and voltage connections are correct. In particular the following rules have to be observed:

Current clamp-on current transformers

- The arrow marked on the clamp-on current transformer has to point in the direction of current flow, from supply to load;
- If the clamp-on current transformer is connected in reverse the measured power in that phase would normally appear negative.

Phase relationships

- The clamp-on current transformer connected to current input connector I1 has to measure the current in the phase line to which the voltage probe from L1 is connected.

In case of events capturing, it is recommended to connect unused voltage inputs to N voltage input.

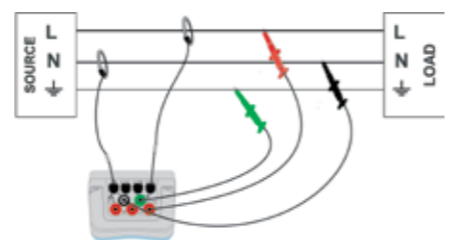

Connection to 1-phase 3-wire system

Power Quality Testing

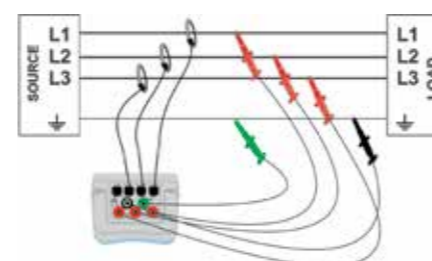

Connection to 3-phase 3-wire system

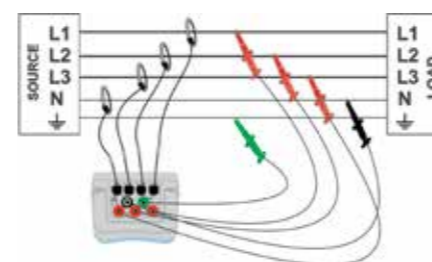

Connection to 3-phase 4-wire system

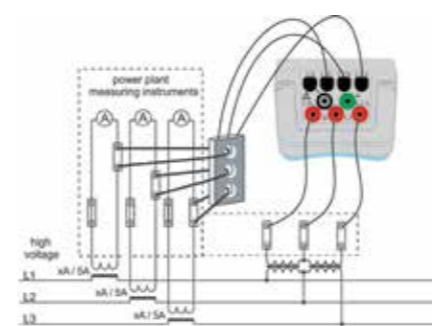

Connecting instrument to the existing current transformers in medium voltage system

Recommended Recording Practice

Power quality measurements are specific type of measurements, which can last several days or even up to several weeks. Usually recording campaign is performed to:

- Statistically analyze some point in the network.
- Troubleshoot malfunctioning device or machine.

Mostly long-term measurements are performed only once, so why it is very important to properly set measuring equipment. Measuring with wrong setting can lead to false or useless measurement results. In the following flow chart recommended recorder procedure is shown (with MI 2792 PowerQ4 Plus instrument).

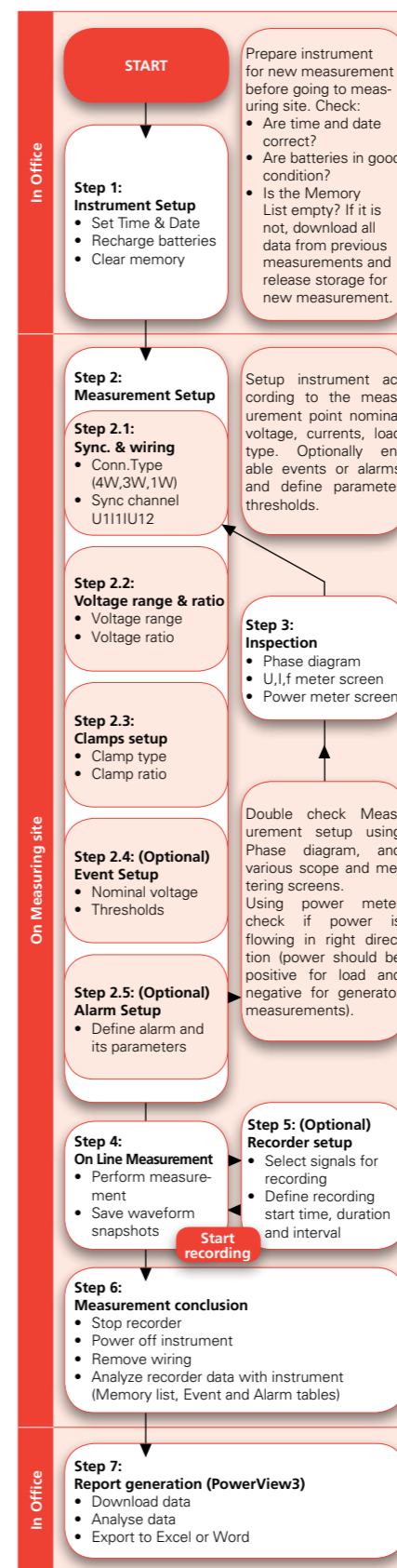

Power quality improvement

Captured with Power Analyser data can be used for improvement of supplied power quality. There are different ways to increase efficiency of power supply.

Cutting power peaks

One of the simplest and the most efficient way to decrease the electricity power bill is by lowering peaks of consumed power (peak demand). This can be achieved by:

- reorganization of production processes;
- embedded generation.

The first solution can be implemented in systems where some tasks can be stopped or rescheduled.

The second solution can be implemented in systems with generators that are often used as a back-up power supply.

Both solutions require additional monitoring and control systems that are designed upon previously conducted measurement and analysis of the situation in the field. Another possibility to increase efficiency is by increasing the power factor using corrective techniques.

Capacitor Banks

Capacitor banks are the devices most susceptible to the presence of harmonics. Since consumer's loads usually have inductive characteristics, capacitor banks are used for compensation of inductive currents. This feature allows:

- better overall system performance;
- increasing availability of active power;
- decreasing transmission losses;
- increasing voltage;
- decreasing financial penalty because of poor power factor.

EN 50160 Standard Overview

EN 50160 is one of the most important standards in field of power quality which defines, describes and specifies the main characteristics of the voltage at a network user's supply terminals in public low voltage and medium voltage distribution networks under normal operating conditions. This standard describes the limits or values within which the voltage characteristics can be expected to remain over the whole of the public distribution network and does not describe the average situation usually experienced by an individual network user.

Selection Guide for Power Quality Analysers

Part No.	NEW MI 2892 PowerMaster	MI 2792A PowerQ4 Plus
INPUTS		
Number of current measuring inputs	4	4
Number of voltage measuring inputs	4	4
Automatic Smart Clamp detection	✓ (Smart range selection)	✓
MEASUREMENTS		
TRMS Current measurement (Min., Max., Avg.)	✓	✓
TRMS Voltage measurement (Min., Max., Avg.)	✓	✓
Scope function	✓	✓
On-line harmonics measurement	✓	✓
Frequency measurement	✓	✓
Power measurement (W, VA, VAR)	✓	✓
THD and harmonics analysis	✓	✓
Interharmonics analysis	✓	✓
Power Factor and cos φ	✓	✓
Registration of voltage events (sags, swells, interruptions)	✓	✓
Statistical evaluation	-	-
Current in neutral conductor	✓	✓
Phase diagram	✓	✓
Unbalance	✓	✓
EN 50160 Analysis	✓	✓
Flicker measurement	✓	✓
Transients measurement	✓	✓ (without trigger, Level)
Waveform recording	✓	✓
Inrush currents	✓	✓
Energy measurement	✓	✓
Signalling	✓	✓
Temperature measurement	✓	✓
Integration period	1 ... 3600 s	1 ... 3600 s
Power measurements in compliance with IEEE 1459	✓	-
Simultaneous General/waveform/inrush	✓	-
Colour coding	✓	-
COMMUNICATION PORTS		
USB	✓	✓
RS232	✓	✓
GPS time synchronisation	✓	✓
Remote instruments control (GPRS)	-	Option
Remote instruments control (Ethernet)	✓	-
GENERAL		
Graphical LCD with backlight	480 x 272 4.3 inch color TFT	320 x 200 dots
On-site analysis of recorded data	✓	✓
Built-in power supply for flexible clamps	✓	✓
Maximal recording time	Over a year	4 ... 8 weeks
Memory module size	8 GB supplied, up to 32 GB	8 MB
PC Software	✓	✓
Maximal test voltage – interphase value	1730 V rms	1730 V rms
Maximal test voltage – between phase and PE conductors	1000 V rms	1000 V rms
Frequency range	10 ... 70 Hz	10 ... 70 Hz
Over voltage category	CAT IV / 600 V CAT III / 1000 V	CAT IV / 600 V CAT III / 1000 V
AC power supply	✓	✓
Built-in battery charger	✓	✓
Rechargeable batteries (NiMH)	6 x AA	6 x AA
Battery life (typically)	6 h	15 h
Weight	0.96 kg	0.65 kg
Dimensions (mm)	230 x 140 x 80	220 x 115 x 90

Selection Guide for Power Quality Analysers

	MI 2792 PowerQ4 Plus	MI 2592 PowerQ4	MI 2392 PowerQ ^{Plus}	MI 2492 PowerQ	MI 2130 VoltScanner
	4	4	3	3	-
	4	4	3	3	1
	✓	✓	✓	✓	-
	✓	✓	✓	✓	-
	✓	✓	✓	✓	✓ (rms only)
	✓	✓	✓	✓	-
	✓	✓	✓	✓	-
	✓	✓	✓	✓	✓
	✓	✓	✓	✓	-
	✓	✓	✓	✓	-
	✓	✓	✓	✓	-
	✓	✓	✓	✓	-
	✓	✓	✓	✓	✓
	-	-	-	-	✓
	✓	✓	calculated value	calculated value	-
	✓	✓	✓	✓	-
	✓	✓	✓	✓	-
	✓	✓	✓ (without flicker measurement)	✓ (without flicker measurement)	1-phase, without flicker measurement
	✓	✓	-	-	-
	✓ (without trigger, Level)	-	-	-	1-phase, voltage transients
	✓	✓ (snapshot)	✓ (snapshot)	✓ (snapshot)	-
	✓	✓	✓	✓	-
	✓	✓	✓	✓	-
	✓	✓	✓	✓	-
	✓	✓	✓	✓	-
	1 ... 3600 s	1 ... 3600 s	1 ... 3600 s	1 ... 3600 s	1 ... 1260 s
	-	-	-	-	-
	-	-	-	-	-
	-	-	-	-	-
	✓	✓	✓	✓	Option
	✓	✓	✓	✓	✓
	Option	-	-	-	-
	Option	-	-	-	-
	-	-	-	-	-
	320 x 200 dots	320 x 200 dots	320 x 200 dots	320 x 200 dots	-
	✓	✓	✓	✓	-
	✓	✓	✓	✓	-
	4 ... 8 weeks	4 ... 8 weeks	4 ... 8 weeks	4 ... 8 weeks	2 ... 4 weeks
	8 MB	8 MB	8 MB	8 MB	32 kB
	✓	✓	✓	✓	✓
	1730 V rms	1730 V rms	952 V rms	952 V rms	265 V rms
	1000 V rms	1000 V rms	550 V rms	550 V rms	265 V rms
	10 ... 70 Hz	10 ... 70 Hz	45 ... 66 Hz	45 ... 66 Hz	47 ... 62 Hz
	CAT IV / 600 V CAT III / 1000 V	CAT IV / 600 V CAT III / 1000 V	CAT IV / 600 V	CAT IV / 600 V	CAT III / 300 V
	✓	✓	✓	✓	✓
	✓	✓	✓	✓	✓
	6 x AA	6 x AA	6 x AA	6 x AA	4 x AA
	15 h	15 h	15 h	15 h	180 h
	0.65 kg	0.65 kg	0.65 kg	0.65 kg	0.51 kg
	220 x 115 x 90	220 x 115 x 90	220 x 115 x 90	220 x 115 x 90	103 x 51 x 199

Selection Guide for Clamps

Part No.	Smart Clamps	Description	Target application	MI 2892	MI 2792A	MI 2792	MI 2592	MI 2392	MI 2492
A 1281		Current clamp 0.5/5/100/1000 A / 1 V	High accuracy current clamp 0.5/5/100/1000 A / 1 V for precise current and power measurements including leakage current measurement.	✓	✓	✓	✓	✓*	✓*
A 1033		Current clamp 1000 A / 1 V	High accuracy current clamp 1000 A / 1 V with jaw opening 52 mm and fixed 1.5 m cable for power measurements with Metrel power quality analysers.	☑	☑	☑	☑	☑	☑
A 1122		Mini current clamp 5 A / 1 V	Mini current clamp 5 A / 1 V with jaw opening 15 mm for power measurements. Requires A 1039 connection cable.	☑	☑	☑	☑	☑	☑
A 1069		Mini current clamp 100 A / 1 V	Mini current clamp 100 A / 1 V with jaw opening 15 mm for power measurements. Requires A 1039 connection cable.	☑	☑	☑	☑	☑	☑
A 1227		1-phase flexible current clamp 3000/300/30 A / 1 V	Single phase flexible current clamp with three selectable measuring ranges. Does not require external power supply as it is powered by the measuring instrument.	✓	✓	✓	✓	✓*	✓*
A 1446		1-phase flexible current clamp 6000/600/60 A / 1 V	Single phase flexible current clamp with three selectable measuring ranges. Does not require external power supply as it is powered by the measuring instrument.	✓	✓	✓	✓	✓*	✓*
A 1257		3-phase flexible current clamp 3000/300/30 A / 1 V	3-phase flexible current clamp with three selectable measuring ranges. Powered by alkaline or rechargeable batteries.	☑	☑	☑	☑	☑	☑
A 1287		1-phase flexible current clamp 3000/300/30 A / 1 V	Single phase flexible current clamp with three selectable measuring ranges. Powered by alkaline or rechargeable batteries.	☑	☑	☑	☑	☑	☑
A 1179		3-phase flexible current clamp 2000/200/20 A / 1 V	3-phase flexible current clamp with three selectable measuring ranges. Powered by alkaline or rechargeable batteries.	☑	☑	☑	☑	☑	☑
A 1037		Current transformer 5 A / 1 V	3-phase transformer for power measurements on distribution panels with 5 A nominal output current.	☑	☑	☑	☑	☑	☑

*MI 2492, MI 2392 supported from HW4 / FW9.2

SMART CLAMPS KEY FEATURES:

- Cover wide current range;
- Are automatically recognized by the instrument;
- Are switchless (range selection on the instrument);
- Do not require external power supply.

✓ Highly recommended ☑ Compatible

Selection Guide for Clamps

Part No.	Type	Jaw opening	Ranges	Measurement Ranges	RMS accuracy 50 Hz	Phase accuracy 50 Hz	RMS accuracy 1500 Hz	Phase accuracy 1500 Hz	Overvoltage category; IP	
A 1281		Iron	52 mm	0.5 A 5 A 100 A 1000 A	10 mA ... 1 A 0.5 A ... 10 A 10 A ... 175 A 100 A ... 1200 A	± 0,5 % ± 0,5 % ± 0,5 % ± 1,2 %	< 0.5°	± 1.5 %	< 1.5°	CAT III / 600 V; IP 20
A 1033		Iron	52 mm	1000 A 100 A	50 A ... 1200 A 5 A ... 200 A*	± 2 % ± 3 %	< 2°	± 3.5 %	< 3°	CAT III / 600 V; IP 20
A 1122		Iron	15 mm	5 A 0.5 A	250 mA ... 10 A 25 mA ... 1 A*	± 2 % ± 2 %	< 6°	± 3 %	< 6°	CAT III / 600 V; IP 20
A 1069		Iron	15 mm	100 A 10 A	5 A ... 200 A 500 mA ... 20 A*	± 2 % ± 2 %	< 3°	± 3 %	< 2°	CAT III / 600 V; IP 20
A 1227		Flex	φ 14 cm	30 A 300A 3000 A	3 A ... 60 A 10 A ... 600 A 60 A ... 6000 A	± 1 % ± 1 % ± 1 %	< 1°	± 3 %	< 10°	CAT III / 600 V; IP 64
A 1446		Flex	φ 27 cm	60 A 600A 6000 A	6 A ... 120 A 20 A ... 1200 A 120 A ... 12000 A	± 1 % ± 1 % ± 1 %	< 1°	± 3 %	< 10°	CAT III / 600 V; IP 64
A 1257		Flex	φ 14 cm	30 A 300 A 3000 A	3 A ... 60 A 10 A ... 600 A 60 A ... 6000 A	± 1 % ± 1 % ± 1 %	< 1°	± 3 %	< 10°	CAT III / 600 V; IP 64
A 1287		Flex	φ 14 cm	30 A 300 A 3000 A	3 A ... 60 A 10 A ... 600 A 60 A ... 6000 A	± 1 % ± 1 % ± 1 %	< 1°	± 3 %	< 10°	CAT III / 600 V; IP 64
A 1179		Flex	φ 14 cm	20 A 200 A 2000 A	2 A ... 40 A 7 A ... 400 A 40 A ... 4000 A	± 1 % ± 1 % ± 1 %	< 1°	± 3 %	< 10°	CAT III / 600 V; IP 64
A 1037		Iron	N/A	0.5 A 5 A	10 mA ... 1 A 0.5 A ... 10 A*	± 0,3 % ± 0,3 %	< 0.5°	± 1 %	< 1.0°	CAT III / 600 V; IP 40

*Range is available only on PowerQ series instruments: MI 2492, MI 2392, MI 2592, MI 2792, MI 2792A and MI 2892.

MI 2892 PowerMaster

The MI 2892 PowerMaster is a hand-held three phase power quality analyser with a large easy-to-read graphical colour display enabling the user to detect harmonics, phasors and waveforms anomalies in the installation simply by connecting the device. The instrument is designed for a long term recording as well as for troubleshooting power quality problems in three-phase and single-phase power distribution systems. The handy Quick Set buttons makes the instrument more user friendly and are allowing faster data overview for troubleshooting. Advanced PC SW package PowerView3 enables detailed analysis of recorded data, direct reading from the microSD memory card, analysis of long term records and automatic creation of professional test report.

MEASURING FUNCTIONS:

- Voltage: TRMS, peak, crest factor (4-channel);
- Current: TRMS, peak, crest factor (4-channel);
- Power (active, reactive, apparent);
- Power measurements fully compliant with IEEE 1459 (active, nonactive, fundamental, harmonic, load unbalance);
- Unbalance, flicker measurement;
- Harmonic and interharmonic analysis up to 50th harmonics, THD measurement;
- Energy (active, reactive, generated, consumed);
- Capturing and recording of power supply events (shutdowns, interruptions, swells, dips);
- Inrush currents monitoring and recording;
- Waveform/inrush displaying, snapshot and recording;
- Transients recording;
- Power quality analysis according to EN 50160;
- Recording up to 7 adjustable alarms;
- Temperature measurement;
- Power factor $\cos \phi$.

KEY FEATURES:

- 4-voltage channels with wide measurement range: 0 ... 1000 Vrms (CAT III / 1000 V);
- 4-current channels with support for automatic clamp recognition and "on instrument" range selection;
- Automatic Smart Clamp detection and Smart Clamp range selection;
- Sampling frequency on transients recording > 50 kHz;
- Compliance with power quality standard IEC 61000-4-30 Class A;
- Complete power quality analysis according to EN 50160 including signalling and interharmonics;
- Support for microSD memory card (8-GB supplied with the instrument) up to 32GB;
- Color-coded input terminals and terminal labels to suit your application region;
- Intuitive main menu and large icons

that makes the equipment very easy to navigate and configure;

- Powerful PC SW PowerView3 enables downloading, view, analysis of recorded data and professional report creation;
- Flexible clamps (without additional power supply) are included in the standard set;
- Remote communication via Ethernet (GPS clock synchronization - optional).

APPLICATION:

- Power quality assessment and troubleshooting in low and middle voltage electrical systems;
- Checking power correction equipment



- performance;
- Long-term analysis;
- Predictive maintenance;
- Verification of electrical system capacity before adding loads.

STANDARDS:

Functionality: IEC/EN 61000-4-30, Class A; IEC/EN 61557-12; IEC/EN 61000-4-7, Class I; IEC/EN 61000-4-15; EN 50160; IEEE 1448; IEEE 1459

Electromagnetic compatibility: EN 61326

Safety: EN 61010-1

TECHNICAL SPECIFICATION:

Function		
Voltage inputs	AC/DC	
Number of inputs	4	
Nominal voltage range (L – N)	Phase (L-N): 50 ÷ 1000 Vrms / Line (L-L): 50 ÷ 1730 Vrms	
Measuring range	10% ÷ 150% of nominal voltage	
Accuracy	IEC 61000-4-30 Class A, ±0.1% of nominal voltage,	
Sampling rate	5.120 kSamples per sec @ 50/60 Hz, sync with mains freq.	
Mains frequency range	40 ÷ 70 Hz ±10 mHz	
Current inputs	AC/DC	
Number of inputs	4	
Measuring range		
(with A1227 flex clamps)	3 ÷ 6000 Arms ±1.5% of m.v.	
Measuring range		
(with A1281 iron clamps)	50 m ÷ 1200 Arms ±0.5% of m.v.	
Functions	Measuring range	Accuracy
Power (P, Q, S, $\cos \phi$, PF...)	Depends on voltage and selected clamps	IEC 61557-12 Class 1
Energy	Depends on voltage and selected clamps	Active: IEC 62053-21 Class 1 Reactive: IEC 62053-23 Class 2
Harmonics (DC ÷ 50th)	0 ÷ 20% of nom. voltage	IEC 61000-4-7 Class 1
Interharmonics (1 ÷ 50th)	0 ÷ 20% of nom. voltage	IEC 61000-4-7 Class 1
Flicker	0.2 ÷ 10	IEC 61000-4-15 Class F3
Mains signalling	0 ÷ 15% of nom. voltage	IEC 61000-4-30 Class A
Unbalance	Voltage: 0 ÷ 5% Current: 0 ÷ 17%	
Temperature	-10 ÷ 85 °C	±0.5 °C
Dips, Swell	10 ÷ 150% of nom. voltage	±0.2 % of nominal voltage ±1 cycle
Interruptions	0 ÷ 10% of nom. voltage	±1 cycle
Recorders		
Memory	8GB microSD, up to 32GB supported	
General recorder		
Integration period	1s ... 1h	
Recorded signals	> 1000 (voltages, currents, harmonics, power...) Minimal, maximal and average value per interval - Voltage events - Custom alarms	
Duration	> 1 year (depends on size of SD card)	
Waveform recorder		
Duration	Up to 20 seconds of voltage and current waveform	
Trigger	Manual, Voltage Events, Custom Alarms, voltage or current level (inrush)	
Transient recorder		
Sampling rate	> 50ksamples/sec	
Duration	Up to 50 cycles of voltage and current waveform	
Trigger	Manual, voltage envelope or level	
General		
Display	4.3 inch color TFT (480 x 272)	
Communication	USB, Ethernet, RS-232	
Time synchronisation	GPS receiver (A 1355)	
Power supply	110 ÷ 240 Vac or 6 x NiMH rechargeable batteries, size AA	
Overvoltage category	CAT IV / 600 V or CAT III / 1000 V	
Weight	1 kg	
Dimensions	230 x 140 x 80 mm	

STANDARD SET:

MI 2892

- Instrument PowerMaster
- 1-phase flexible current clamps 3000 / 300 / 30 A
- (A 1227), 4 pcs
- Test probe, (brown, black, grey, green, blue), 5 pcs
- Crocodile clip, (brown, black, grey, green, blue), 5 pcs
- Voltage measurement lead, (brown, black, grey, green, blue), 5 pcs

- Temperature probe
- microSD memory card 8.0GB
- PC SW PowerView3
- RS232, USB and Ethernet patch cable
- Power supply adapter
- 1.2 V NiMH rechargeable battery, 6 pcs
- Soft carrying bag
- Instruction manual
- Calibration certificate



MI 2792A PowerQ4 Plus

The MI 2792A PowerQ4 Plus is top of the range power quality analyser. With its 4 current and 4 voltage channels it is suitable for locating, predicting and troubleshooting of problems in three and in single phase power distribution systems. All 4 current channels have the ability to automatically recognize clamps whose range can be set on the instrument. Rugged design makes it appropriate for field use. It can operate up to 15 hours on a single battery charge. Parameters of the instrument can be set directly on the instrument, via the PowerView3 software or remotely true the optional GPRS modem connection. It is compliant with power quality standard IEC 61000-4-30 Class A, and it has a predefined recorder profile for EN 50160 survey.

MEASURING FUNCTIONS:

- Voltage: TRMS, peak, crest factor (4-channel);
- Current: TRMS, peak, crest factor (4-channel);
- Power (active, reactive, apparent);
- Power factor, $\cos \varphi$;
- Unbalance, flicker measurement;
- Harmonic and interharmonic analysis up to 50th harmonics, THD measurement;
- Energy (active, reactive, generated, consumed);
- Capturing and recording of power supply events (shutdowns, interruptions, swells, dips);
- Inrush currents monitoring and recording;
- Waveform displaying, snapshot and recording;
- Transients recording;
- Power quality analysis according to EN 50160;
- Recording up to 10 adjustable alarms;
- Temperature measurement.

KEY FEATURES:

- 4 voltage channels with wide measurement range: 0 ... 1000 Vrms (CAT III / 1000 V).
- 4 current channels with support for automatic clamp recognition and "on instrument" range selection.
- Compliance with power quality standard IEC 61000-4-30 Class A.
- Power measurements compliance with IEC 61557-12 and IEEE 1448 standards.
- Complete power quality analysis according to EN 50160 including signalling and interharmonics.
- Capture of voltage events and user defined alarms.
- 4-quadrant measurements (generator and load with capacitive or inductive character).
- Up to 524 parameters can be monitored or recorded simultaneously.
- 8 MB of internal memory space allows recording over 4 weeks.
- Powerful troubleshooting tools: transient, inrush / fast and waveform recording.
- On-screen displaying of trends and captured events and simultaneous recording in the background.



- Temperature probe for measurement of the temperature of the tested transformer, capacitor bank, etc.
- Possibility of remote control of the instrument or group of them via GPRS modem.
- Flexible clamps (without additional power supply) are included in the standard set.
- 15 hours of autonomous (battery) supply.
- Powerful PC SW PowerView3 enables downloading, view, analysis of recorded data and professional report creation.

STANDARDS:

Functionality: IEC/EN 61000-4-30, Class A; IEC/EN 61557-12; IEC/EN 61000-4-7, Class I; IEC/EN 61000-4-15; EN 50160; IEEE 1448
Electromagnetic compatibility: EN 61326
Safety: EN 61010-1

IEC 61000-4-30 CLASS A :

IEC 61000-4-30	Class
Measurement aggregation over time intervals	A
Aggregation algorithm	S
Magnitude of the Supply L-N Voltage magnitude	A
L-L Voltage magnitude	S
Dips and Swells L-N Voltage magnitude	A
L-L Voltage magnitude	S
Real time clock uncertainty	A
Frequency	A
Flicker*	A
Interruptions	A
Unbalance	A
Voltage Harmonics	A
Voltage Interharmonics	A
Mains signalling voltage	A

* Class A in range 49-51 Hz, see Instruction Manuals for details.

TECHNICAL SPECIFICATION:

Function	Measuring range	Resolution	Accuracy
AC Voltage inputs			
Number of inputs	4		
Input voltage range	20 ... 1500 Vrms L - N (20 ... 2600 Vrms L - L)		
Basic accuracy	0.1% of nominal voltage (Unom: 50 ... 1000 Vrms)		
Resolution	10 mV, 100 mV		
Sampling rate	1024 samples per 10 periods		
Frequency range	10 ... 70 Hz		
AC Current inputs			
Number of inputs	4		
Input voltage range	20.0 mVrms ... 2 Vrms		
Current measuring range	100 ... 6000 A (depending on clamps)		
Resolution	100 mV		
Basic accuracy	0.25% of reading		
Sampling rate	1024 samples per 10 periods		
Function			
Frequency	10.00 ... 70.00 Hz	2 mHz	±10 mHz
Power (W, VA, VAR)	0.000 k ... 9.999 M	4 digits	±0.5% of reading
Power factor	-1.00 ... 1.00	0.01	±0.02
cos φ	0.00 ... 1.00	0.01	±0.02
Harmonics analysis up to 50 th component	U _{hN} < 1% · U _{nom} 1% · U _{nom} < U _{hN} < 20% · U _{nom} I _{hN} < 10% · I _N 10% · I _N < I _{hN} < 100% · I _N	10 mV 10 mV 10 mV 10 mV	±0.15% · U _{nom} ±5% · U _{hN} ±0.15% · I _N ±5% · I _{hN}
THD	0% · U _{nom} < THD _U < 20% · U _{nom} 0% · I _N < THD _I < 100% · I _N 100% · I _N < THD _I < 200% · I _N	0.1% 0.1% 0.1%	±0.3 ±0.6 ±1.5
Signalling	1% · U _N < U _{sig} < 3% · U _N 3% · U _N < U _{sig} < 20% · U _N	10 mV 10 mV	±0.15% · U _N ±5% · U _{sig}
Voltage dips and swells			
Magnitude	20 ... 1500 V	10 mV, 100 mV	0.2% · U _{nom}
Duration	30 ms ... 7 days	1 ms	±1 cycle
Temperature	-20 °C ... -10 °C -10 °C ... +85 °C +85 °C ... +125 °C	0.1 °C 0.1 °C 0.1 °C	±2.0 °C ±0.5 °C ±2.0 °C
Recording			
General recorder	Records up to 524 parameters (min, max, avg) Duration: 1 sec ... 99 days Integration interval: 1 sec ... 60 min Trigger: Manual, Time		
Waveform recorder	Records up to 8 parameters (U ₁ ... U _N , I ₁ ... I _N) Duration: 1 cycle period up to 3770 cycle periods Sampling: 5120 samples / sec (for 50 Hz signals) Trigger: Manual, Event or Alarm Table		
Inrush / Fast recorder	Records up to 8 parameters (U ₁ ... U _N , I ₁ ... I _N) Duration: 1 sec ... 3 min Sampling: 1 reading per half-cycle up to 1 reading per 10-cycle Trigger: Manual, Current or Voltage Threshold		
Transient recorder	Record up to 8 parameters (U ₁ ... U _N , I ₁ ... I _N) Duration: up to 47 periods Sampling: 51200 samples / sec (for 50 Hz signals) Trigger: Manual, Voltage Envelope (dV)		
COM port	RS232 and USB		
Display	Graphic LCD with backlight, 320 x 200 dots		
Memory module	8 MB Flash		
Voltage supply	230 Vac or 6 x 1.2 V NiMH rechargeable batteries, type AA		
Over voltage category	CAT III / 1000 V; CAT IV / 600 V		
Protection class	Double insulation		
Dimensions	220 x 115 x 90 mm		
Weight	0.65 kg		

STANDARD SET:

- MI 2792A**
- Instrument PowerQ4 Plus
 - 1-phase flexible current clamps 3000 / 300 / 30 A (A 1227), 4 pcs
 - GPS receiver
 - Test probe, red, 3 pcs
 - Test probe, black
 - Crocodile clip, black
 - Crocodile clip, green
 - Crocodile clip, red, 3 pcs
 - Voltage measurement lead, red, 3 pcs

- Voltage measurement lead, black
- Voltage measurement lead, green
- Temperature probe
- PC SW PowerView3
- RS232 and USB cables
- Power supply adapter
- 1.2 V NiMH rechargeable battery, 6 pcs
- Soft carrying bag
- Instruction manual
- Calibration certificate



MI 2792 PowerQ4 Plus

The MI 2792 PowerQ4 Plus is a power quality analyser specially designed for troubleshooting of power systems and devices. Rugged design, long battery autonomy (up to 15 hours), powerful recorders, events and alarms capture, flex current clamps as standard accessory, remote instrument control via optional GPRS modem, ability to synchronize instruments via GPS make this instrument unique troubleshooting tool. Advanced PC SW package PowerView3 enables detailed analysis of recorded data and automatic creation of professional test report. Excellent price / performance ratio, small size, advanced measurement methods and loggers are undoubted highlights of the MI 2792.

MEASURING FUNCTIONS:

- Voltage: TRMS, peak, crest factor (4-channel);
- Current: TRMS, peak, crest factor (4-channel);
- Power (active, reactive, apparent);
- Power factor, $\cos \varphi$;
- Unbalance, flicker measurement;
- Harmonic and interharmonic analysis up to 50th harmonics, THD measurement;
- Energy (active, reactive, generated, consumed);
- Capturing and recording of power supply events (shutdowns, interruptions, swells, dips);
- Inrush currents monitoring and recording;
- Waveform displaying, snapshot and recording;
- Transients recording;
- Power quality analysis according to EN 50160;
- Recording up to 10 adjustable alarms;
- Temperature measurement.

KEY FEATURES:

- 4 voltage channels with wide measurement range: 0 ... 1000 Vrms (CAT III / 1000 V).
- 4 current channels with support for automatic clamp recognition and "on instrument" range selection.
- Compliance with power quality standard IEC 61000-4-30 Class S/A.
- Power measurements compliance with IEC 61557-12 and IEEE 1448 standards.
- Complete power quality analysis according to EN 50160 including signalling and interharmonics.
- Capture of voltage events and user defined alarms.
- 4-quadrant measurements (generator and load with capacitive or inductive character).
- Up to 524 parameters can be monitored or recorded simultaneously.
- 8 MB of internal memory space allows recording over 4 weeks.
- Powerful troubleshooting tools: transient, inrush / fast and waveform recording.
- On-screen displaying of trends and captured events and simultaneous recording in the background.



- Temperature probe for measurement of the temperature of the tested transformer, capacitor bank, etc.
- Possibility of remote control of the instrument or group of them via GPRS modem.
- Flexible clamps (without additional power supply) are included in the standard set.
- 15 hours of autonomous (battery) supply.
- Powerful PC SW PowerView3 enables downloading, view, analysis of recorded data and professional report creation.

APPLICATION:

- Power quality assessment and troubleshooting in low and middle voltage electrical systems;
- Checking power correction equipment performance;

- Harmonics spectrum analysis for selection of harmonic filters;
- UPS, voltage generators and regulators checking and troubleshooting;
- Voltage, current, power monitoring and recording;
- Consumption profile recording.

STANDARDS:

Functionality:
IEC/EN 61000-4-30, Class S;
IEC/EN 61557-12;
IEC/EN 61000-4-7, Class II;
IEC/EN 61000-4-15;
EN 50160; IEEE 1448

Electromagnetic compatibility:
EN 61326

Safety:
EN 61010-1

TECHNICAL SPECIFICATION:

Function	Measuring range	Resolution	Accuracy
AC Voltage inputs			
Number of inputs	4		
Input voltage range	20 ... 1500 Vrms L - N (20 ... 2600 Vrms L - L)		
Basic accuracy	0.2% of reading		
Resolution	10 mV, 100 mV		
Sampling rate	1024 samples per 10 periods		
Frequency range	10 ... 70 Hz		
AC Current inputs			
Number of inputs	4		
Input voltage range	20.0 mVrms ... 2 Vrms		
Current measuring range	3 ... 6000 A (for current clamp A 1227)		
Resolution	0.1 mV (0.1 A for current clamp A 1227)		
Basic accuracy	0.25 % of reading		
Sampling rate	1024 samples per 10 periods		
Function	Measuring range	Resolution	Accuracy
Frequency	10.00 ... 70.00 Hz	2 mHz	±10 mHz
Power (W, VA, VAR)	0.000 k ... 9.999 M	4 digits	±0.5 % of reading
Power factor	-1.00 ... 1.00	0.01	±0.02
$\cos \varphi$	0.00 ... 1.00	0.01	±0.02
Harmonics analysis up to 50 th component	$U_{hN} < 3 \% \cdot U_{nom}$	10 mV	±0.15 % · U_{nom}
	$3 \% \cdot U_{nom} < U_{hN} < 20 \% \cdot U_{nom}$	10 mV	±5 % · U_{hN}
	$I_{hN} < 10 \% \cdot I_N$	10 mV	±0.15 % · I_N
	$10 \% \cdot I_N < I_{hN} < 100 \% \cdot I_N$	10 mV	±5 % · I_{hN}
THD	$0 \% \cdot U_{nom} < THD_U < 20 \% \cdot U_{nom}$	0.1%	±0.3
	$0 \% \cdot I_N < THD_I < 100 \% \cdot I_N$	0.1%	±0.6
	$100 \% \cdot I_N < THD_I < 200 \% \cdot I_N$	0.1%	±1.5
Signalling	$1 \% \cdot U_N < U_{sig} < 3 \% \cdot U_N$	10 mV	±0.15 % · U_N
	$3 \% \cdot U_N < U_{sig} < 20 \% \cdot U_N$	10 mV	±5 % · U_{sig}
Voltage dips and swells			
Magnitude	20 ... 1500 V	10 mV, 100 mV	0.5 % of reading
Duration	30 ms ... 7 days	1 ms	±20 ms
Temperature	-20 °C ... -10 °C	0.1 °C	±2.0 °C
	-10 °C ... +85 °C	0.1 °C	±0.5 °C
	+85 °C ... +125 °C	0.1 °C	±2.0 °C
Recording	Records up to 524 parameters (min, max, avg)		
General recorder	Duration: 1 sec ... 99 days Integration interval: 1 sec ... 60 min Trigger: Manual, Time		
Waveform recorder	Records up to 8 parameters (U_1 ... U_N , I_1 ... I_N) Duration: 1 cycle period up to 3770 cycle periods Sampling: 5120 samples / sec (for 50 Hz signals) Trigger: Manual, Event or Alarm Table		
Inrush / Fast recorder	Records up to 8 parameters (U_1 ... U_N , I_1 ... I_N) Duration: 1 sec ... 3 min Sampling: 1 reading per half-cycle up to 1 reading per 10-cycle Trigger: Manual, Current or Voltage Threshold		
Transient recorder	Record up to 8 parameters (U_1 ... U_N , I_1 ... I_N) Duration: up to 47 periods Sampling: 51200 samples / sec (for 50 Hz signals) Trigger: Manual, Voltage Envelope (dV)		
COM port	RS232 and USB		
Display	Graphic LCD with backlight, 320 x 200 dots		
Memory module	8 MB Flash		
Voltage supply	230 Vac or 6 x 1.2 V NiMH rechargeable batteries, type AA		
Over voltage category	CAT III / 1000 V; CAT IV / 600 V		
Protection class	Double insulation		
Dimensions	220 x 115 x 90 mm		
Weight	0.65 kg		

STANDARD SET:

MI 2792

- Instrument PowerQ4 Plus
- 1-phase flexible current clamps 3000 / 300 / 30 A (A 1227), 4 pcs
- Test probe, red, 3 pcs
- Test probe, black
- Crocodile clip, black
- Crocodile clip, green
- Crocodile clip, red, 3 pcs
- Voltage measurement lead, red, 3 pcs
- Voltage measurement lead, black

- Voltage measurement lead, green
- Temperature probe
- PC SW PowerView3
- RS232 and USB cables
- Power supply adapter
- 1.2 V NiMH rechargeable battery, 6 pcs
- Soft carrying bag
- Instruction manual
- Calibration certificate



MI 2592 PowerQ4

The MI 2592 PowerQ4 is a handheld, simple to use, portable power quality analyser with four current and four voltage measuring channels. Integrated in rugged housing and packed with powerful functions it can be effectively used for monitoring, troubleshooting and analysing of power quality conditions in power distribution networks either in industry or utilities. The PowerQ4 is the first handheld power quality analyser which is compliant with power quality standard IEC 61000-4-30 Class S and standard IEC 61557-12. Powerful PC Software package PowerView3 comes delivered as part of a standard set and enables downloading, analysing of recorded data and creation of test reports. Through a simple but powerful interface PowerView3 helps to find recorded data quickly and allows to make complex analysis and data comparison.

MEASURING FUNCTIONS:

- Voltage: TRMS, peak, crest factor (4-channel);
- Current: TRMS, peak, crest factor (4-channel);
- Power (active, reactive, apparent);
- Power factor, $\cos \varphi$;
- Unbalance, flicker measurement;
- Harmonic analysis up to 50th harmonics, THD measurement;
- Energy (active, reactive, generated, consumed);
- Capturing and recording of power supply events (shutdowns, interruptions, swells, dips);
- Inrush currents monitoring and recording;
- Waveform displaying and snapshot;
- Power quality analysis according to EN 50160;
- Recording up to 10 adjustable alarms.

KEY FEATURES:

- 4 voltage channels with wide measurement range: 0 ... 1000 Vrms (CAT III / 1000 V).
- 4 current channels with support for automatic clamp recognition.
- Compliance with power quality standard IEC 61000-4-30 Class S.
- Power measurements compliance with IEC 61557-12 and IEEE 1448 standards.
- Simultaneous measurement and recording of basic power quality parameters (U, I, P, Q, S, PF, $\cos \varphi$, THD).
- Power quality analysis according to EN 50160 including flicker measurement and standardized report printout in graphic and table form.
- 4-quadrant measurements (generator and load with capacitive or inductive character).
- Up to 509 parameters can be monitored or recorded simultaneously.
- 8 MB of internal memory space allows recording over 4 weeks.
- On-line Scope, Trend and Metering modes.



- On-screen displaying of trends and captured events and simultaneous recording in the background.
- Flexible clamps (without additional supply) are included in the standard set.
- Simultaneous 8 channels - 16 bit AD conversion for accurate power measurements (minimal phase shift error)
- 15 hours of autonomous (battery) supply.
- Powerful PC SW PowerView3 enables downloading, view, analysis of recorded data and professional report creation.

APPLICATION:

- Power quality assessment and troubleshooting in low and middle voltage electrical systems;

- Checking power correction equipment performance;
- Harmonics spectrum analysis for selection of harmonic filters;
- UPS, voltage generators and regulators checking and troubleshooting;
- Voltage, current, power monitoring and recording;
- Consumption profile recording.

STANDARDS:

Functionality: IEC/EN 61000-4-30, Class S; IEC/EN 61557-12; IEC/EN 61000-4-7, Class II; IEC/EN 61000-4-15; EN 50160; IEEE 1448

Electromagnetic compatibility: EN 61326

Safety: EN 61010-1

TECHNICAL SPECIFICATION:

Function	Measuring range	Resolution	Accuracy
AC Voltage inputs			
Number of inputs	4		
Input voltage range	20 ... 1500 Vrms L - N (20 ... 2600 Vrms L - L)		
Basic accuracy	0.2 % of reading		
Resolution	10 mV, 100 mV		
Sampling rate	1024 samples per 10 periods		
Frequency range	10 ... 70 Hz		
AC Current inputs			
Number of inputs	4		
Input voltage range	20.0 mVrms ... 2 Vrms		
Current measuring range	3 ... 6000 A (for current clamp A 1227)		
Resolution	0.1 mV (0.1 A for current clamp A 1227)		
Basic accuracy	0.25 % of reading		
Sampling rate	1024 samples per 10 periods		
Function			
Frequency	10.00 ... 70.00 Hz	2 mHz	±10 mHz
Power (W, VA, VAR)	0.000 k ... 9.999 M	4 digits	±0.5 % of reading
Power factor	-1.00 ... 1.00	0.01	±0.02
$\cos \varphi$	0.00 ... 1.00	0.01	±0.02
Harmonics analysis up to 50th component			
	$U_{hN} < 3 \% U_{nom}$	10 mV	0.15 % · U_{nom}
	$3 \% U_{nom} < U_{hN} < 20 \% U_{nom}$	10 mV	5 % · U_{hN}
	$I_{hN} < 10 \% I_N$	10 mV	0.15 % · I_N
	$10 \% I_N < I_{hN} < 100 \% I_N$	10 mV	5 % · I_{hN}
THD			
	$0 \% U_{nom} < THD_U < 20 \% U_{nom}$	0.1 %	±0.3
	$0 \% I_N < THD_I < 100 \% I_N$	0.1 %	±0.6
	$100 \% I_N < THD_I < 200 \% I_N$	0.1 %	±1.5
Voltage dips and swells			
Magnitude	20 ... 1500 V	10 mV, 100 mV	0.5 % of reading
Duration	30 ms ... 7 days	1 ms	±20 ms
Recording			
Integration interval	1 ... 3600 s		
Maximum number of signals	509		
COM port	RS232 and USB		
Display	Graphic LCD with backlight, 320 x 200 dots		
Memory module	8 MB Flash		
Voltage supply	230 V _{AC} or 6 x 1.2 V NiMH rechargeable batteries, type AA		
Over voltage category	CAT III / 1000 V; CAT IV / 600 V		
Protection class	Double insulation		
Dimensions	220 x 115 x 90 mm		
Weight	0.65 kg		

STANDARD SET:

MI 2592

- Instrument PowerQ4
- 1-phase flexible current clamps 3000 / 300 / 30 A (A 1227), 4 pcs
- Test probe, red, 3 pcs
- Test probe, black, green
- Crocodile clip, black, green
- Crocodile clip, red, 3 pcs
- Voltage measurement lead, red, 3 pcs
- Voltage measurement lead, black, green

- PC SW PowerView3
- RS232 and USB cables
- Power supply adapter
- 1.2 V NiMH rechargeable battery, 6 pcs
- Soft carrying bag
- Instruction manual
- Calibration certificate



MI 2392 PowerQ^{Plus}

The MI 2392 PowerQ^{Plus} is a portable multifunction instrument for measurement and analysis of three-phase power systems. Due to the small dimensions and user friendly interface of the MI 2392 PowerQ^{Plus} it is ideally suited for routine or complex power quality assessment, while a rugged case allows to use it in heavy duty industrial environments. Pre-set measuring profiles allow on-site evaluation of all major power quality parameters (U, I, P, Q, S, PF, cos φ, THD, individual harmonic components, etc.) even without using a PC. Built-in memory module ensures up to five days of recording. New powerful PC Software package PowerView3 comes delivered as part of a standard set and enables downloading, complex analysing and comparison of recorded data and creation of test reports.

MEASURING FUNCTIONS:

- TRMS voltage;
- TRMS current;
- Power (active, reactive, apparent);
- Power factor, cos φ;
- Energy (active, reactive, generated, consumed);
- Power quality analysis according to EN 50160;
- Harmonic analysis up to 50th harmonics, THD measurement;
- Capturing and recording of power supply events (shut-down's, interruptions, swells, dips);
- Phase diagram and unbalance;
- Inrush currents monitoring and recording.

KEY FEATURES:

- Three current and three voltage inputs.
- Measurement and recording of basic power quality parameters (U, I, P, Q, S, PF, cos φ, THD).
- Power quality analysis according to EN 50160 including standardized report printout.
- 4-quadrant measurements (generator and load with capacitive or inductive character).
- Quick set-up functions.
- On-line scope and metering modes.
- Voltage unbalance calculation for 3-phase systems.
- Recording of anomalies and inrush currents via adjustable triggers.
- Lightweight design.
- Large LCD display enables on-line monitoring of measuring results either in table or graphic form.
- PC SW PowerView3 included in the standard set is used for downloading, management of recorded data and creation of test reports.



APPLICATION:

- Power quality assessment and troubleshooting in low and middle voltage electrical systems;
- Balancing phase loads in 3-phase systems;
- Checking power correction equipment performance;
- Harmonics spectrum analysis for selection of harmonic filters;
- Motor's inrush currents monitoring and recording for in-depth analysis of a machines start-up or shut-down effects on a power network;
- Voltage fluctuation recording;
- Consumption recording.

STANDARDS:

Functionality:
EN 50160;
IEC/EN 61000-4-30, Class B

Electromagnetic compatibility:
IEC/EN 61326-1

Safety:
IEC/EN 61010-1

TECHNICAL SPECIFICATION:

Function	Measuring range	Resolution	Accuracy
AC Voltage inputs			
Number of inputs	3		
Input voltage range	3.0 ... 550.0 Vrms L - N (952.0 Vrms L - L)		
Basic accuracy	± (1 % of reading + 0.5 V)		
Resolution	0.1 V		
Sampling rate	1024 samples per 10 periods		
AC Current inputs			
Number of inputs	3		
Input voltage range	0.04 ... 1 Vrms		
Current measuring range	4 ... 100 A and 40 ... 1000 A (with current clamp A 1033)		
Resolution	0.1 A		
Basic accuracy	± (2 % of reading + 0.3 A)		
Sampling rate	1024 samples per 10 periods		
Function	Measuring range	Resolution	Accuracy
Frequency	45.00 ... 66.00 Hz	10 mHz	± (0.5 % of reading + 0.02 Hz)
Power (W, VA, VAR)	0.000 ... 0.999 k	1	± (3 % of reading + 3 digits)
	0.00 ... 9.99 k	10	
	0.0 ... 999.9 k	100	
	0.000 ... 9.999 M	1 k	
	0.00 ... 99.99 M	10 k	
	0.0 ... 999.9 M	100 k	
Power factor, cos φ	0.00 ... 0.39	0.01	± 0.06
	0.40 ... 1.00	0.01	± 0.03
Harmonics analysis up 50 th component	U _M > 3 % U _N (I _M > 3 % I _N)	0.1 %	5 % U _M (I _M) (3 % for DC) 0.15 % U _N (I _N)
	U _M < 3 % U _N (I _M < 3 % I _N)	0.1 %	
Recording			
Integration period (IP)	1 ... 3600 s		
Maximum number of signals	500		
COM port	RS232 and USB		
Display	Graphic LCD with backlight, 320 x 200 dots		
Memory module	8 MB Flash		
Voltage supply	230 V _{AC} or 6 x 1.2 V NiMH rechargeable batteries, type AA		
Overvoltage category	CAT IV / 600 V		
Protection class	Double insulation		
Dimensions	220 x 115 x 90 mm		
Weight	0.65 kg		

STANDARD SET:

- MI 2392**
- Instrument PowerQ^{Plus}
 - Current clamp 1000 A / 1 V, 3 pcs
 - Test probe, red, 3 pcs
 - Test probe, black
 - Crocodile clip, black
 - Crocodile clip, red, 3 pcs
 - Voltage measurement lead, 4 pcs
 - PC SW PowerView3 with RS232 and USB cable

- Power supply adapter
 - 1.2 V NiMH rechargeable battery, 6 pcs
 - Soft carrying bag
 - Instruction manual
 - Calibration certificate
- MI 2392F**
- MI 2392
 - Current clamp 1000 A (A 1033), 3 pcs, replaced by 1-phase flexible current clamp 3000 / 300 / 30 A (A 1227), 3 pcs.



MI 2392F

MI 2492 PowerQ

The MI 2492 PowerQ is a lightweight, handheld, 3-phase analyser for quick power quality assessment in low and middle voltage systems. All major power quality parameters like U, I, P, Q, S, PF, cos φ, THD, individual harmonic components can be measured, recorded or monitored on-line. Thanks to various pre-set measuring profiles different diagnostics can be performed on-site even without using a PC. The MI 2492 PowerQ is built into a rugged case which allows to use it in harsh industrial conditions. Built-in memory module ensures up to five days of recording. New powerful PC Software package PowerView3 comes delivered as part of a standard set and enables downloading, complex analysing and comparison of recorded data and creation of test reports.

MEASURING FUNCTIONS:

- TRMS voltage;
- TRMS current;
- Power (active, reactive, apparent);
- Power factor, cos φ;
- Energy (active, reactive, generated, consumed);
- Harmonic analysis up to 50th harmonics, THD measurement;
- Phase diagram and unbalance;
- Oscilloscope mode.

KEY FEATURES:

- Three current and three voltage inputs.
- Measurement and recording of basic power quality parameters (U, I, P, Q, S, PF, cos φ, THD).
- 4-quadrant measurements (generator and load with capacitive or inductive character).
- Harmonics analysis up to 50th component.
- Quick set-up functions.
- On-line scope and metering modes.
- Voltage unbalance calculation for 3-phase systems.
- Lightweight design.
- Large LCD display enables on-line monitoring of measuring results either in table or graphic form.
- PC SW PowerView3 included in the standard set is used for downloading, management of recorded data and creation of test reports.

APPLICATION:

- Power quality assessment and troubleshooting in low and middle voltage electric systems;
- Power correction equipment performance testing and designing;
- Selection and designing of harmonics filters;
- Monitoring and managing of consumption profile.



STANDARDS:

Functionality:

EN 50160;
IEC/EN 61000-4-30, Class B

Electromagnetic compatibility:

IEC/EN 61326-1

Safety:

IEC/EN 61010-1

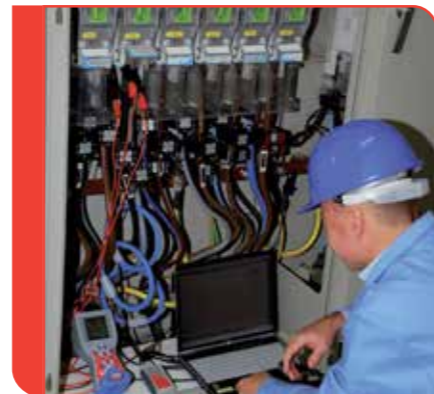

TECHNICAL SPECIFICATION:

Function			
AC Voltage inputs			
Number of inputs	3		
Input voltage range	3.0 ... 550.0 Vrms L - N (952.0 Vrms L - L)		
Basic accuracy	± (1 % of reading + 0.5 V)		
Resolution	0.1 V		
Sampling rate	1024 samples per 10 periods		
AC Current inputs			
Number of inputs	3		
Input voltage range	0.04 ... 1 Vrms		
Current measuring range	4 ... 100 A and 40 ... 1000 A (with current clamp A 1033)		
Resolution	0.1 A		
Basic accuracy	± (2 % of reading + 0.3 A)		
Sampling rate	1024 samples per 10 periods		
Function	Measuring range	Resolution	Accuracy
Frequency	45.00 ... 66.00 Hz	10 mHz	± (0.5 % of reading + 0.02 Hz)
Power (W, VA, VAR)	0.000 ... 0.999 k	1	± (3 % of reading + 3 digits)
	0.00 ... 9.99 k	10	
	0.0 ... 999.9 k	100	
	0.000 ... 9.999 M	1 k	
	0.00 ... 99.99 M	10 k	
	0.0 ... 999.9 M	100 k	
Power factor, cos φ	0.00 ... 0.39	0.01	± 0.06
	0.40 ... 1.00	0.01	± 0.03
Harmonics analysis up 50 th component	U _M > 3 % U _N (I _M > 3 % I _N)	0.1 %	5 % U _M (I _M) (3 % for DC) 0.15 % U _N (I _N)
	U _M < 3 % U _N (I _M < 3 % I _N)	0.1 %	
Recording			
Integration period (IP)	1 ... 3600 s		
Maximum number of signals	500		
COM port	RS232 and USB		
Display	Graphic LCD with backlight, 320 x 200 dots		
Memory module	8 MB Flash		
Voltage supply	230 V _{AC} or 6 x 1.2 V NiMH rechargeable batteries, type AA		
Overvoltage category	CAT IV / 600 V		
Protection class	Double insulation		
Dimensions	220 x 115 x 90 mm		
Weight	0.65 kg		

STANDARD SET:

MI 2492

- Instrument PowerQ
- Current clamp 1000 A / 1 V, 3 pcs
- Test probe, red, 3 pcs
- Test probe, black
- Crocodile clip, black
- Crocodile clip, red, 3 pcs
- Voltage measurement lead, 4 pcs
- PC SW PowerView3 with RS232 and USB cable

- Power supply adapter
 - 1.2 V NiMH rechargeable battery, 6 pcs
 - Soft carrying bag
 - Instruction manual
 - Calibration certificate
- MI 2492F**
- MI 2492
 - Current clamp 1000 A (A 1033), 3 pcs, replaced by 1-phase flexible current clamps 3000 / 300 / 30 A (A 1227), 3 pcs.



MI 2492F

MI 2130 VoltScanner

The MI 2130 VoltScanner is a 1-phase voltage recorder for testing supply voltage on a socket in accordance with EN 50160 power quality standard. Recording up to four weeks is possible and up to 3500 events can be stored into the instrument's memory. The instrument can be easily set up via the PowerView3 software and then sent out to customers who can simply plug in the instrument for the definite period of time and then send it back for analysis. MS Windows compatible PC Software PowerView3 supports programming of the instrument, downloading of recorded data and creation of test reports. Transfer of recorded data to other MS programs (e.g. Excel, Word, etc.) is possible as well.

MEASURING FUNCTIONS:

- Recording of voltage events (dips, swells, interruptions);
- Recording of frequency variations;
- Recording of transient overvoltages;
- Power quality analysis according to EN 50160.

KEY FEATURES:

- The parameters of the measurement are set up via PC SW PowerView3.
- Recording up to 4 weeks is possible.
- Voltage transients down to 1 μ s can be captured.
- Adjustable triggering limits for voltage events.
- Four LEDs indicates the state of the instrument (recorded events, low battery, memory full and incorrect polarity connection).
- Four LEDs indicates the state of the instrument (recorded events, low battery, memory full and incorrect polarity connection).
- PC Software PowerView3 is included in a standard set and supports downloading, data analysis, report creation and programming of the instrument as well.



STANDARD SET:

- MI 2130**
- Instrument VoltScanner
 - Mains measuring cable, 1.5 m
 - 1.2 V NiMH rechargeable battery, 4 pcs
 - PC SW PowerView3
 - RS232 cable
 - Instruction manual
 - Calibration certificate



APPLICATION:

- Supply voltage testing in accordance with EN 50160;
- Ideal solution for IT managers for control of input voltage;
- Voltage monitoring on the customer's side for power distribution companies.

STANDARDS:

- Functionality:**
EN 50160
- Electromagnetic compatibility:**
IEC/EN 61326-1
- Safety:**
IEC/EN 61010-1

TECHNICAL SPECIFICATION:

Measuring function	Measuring range	Accuracy	Resolution
Voltage (swells and dips)	70 ... 265 Vrms	\pm (2% of reading + 2 Vrms)	1 Vrms
Transients	50 ... 2600 V	\pm (10% of reading + 50 Vrms)	5 Vrms
Frequency	47... 62 Hz	\pm 0.1 Hz	0.1 Hz
Interruptions	< 90 Vrms		1 s (for events up to 3.5 min) 8 s (for longer events)
COM port	RS232		
Memory module	32 kB		
Power supply	4 x 1.2 V NiMH rechargeable batteries, type AA		
Over voltage category	CAT III / 300 V		
Protection	Double insulation		
Dimensions	103 x 51 x 199 mm		
Weight	515 g		

MI 2230 VAFMeter

MI 2230 VAFMeter is handheld multifunction instrument which can accurately measure voltage, current, power, harmonic distortion and phase angles in single, two and three phase systems.

MEASURING FUNCTIONS:

- TRMS Two channel voltage measurements, up to 600 Vac;
- TRMS Two channel current measurements, up to 3000 Aac;
- U-U, I-I, U-I angle measurement, phase diagram;
- Support for three-phase (Aaron) systems;
- Active, reactive and apparent power, PF, cos ϕ , THD, frequency;
- Continuity / resistance of conductors with 200 mA test current with polarity change and with pass/fail functionality.



KEY FEATURES:

- Simultaneous measurement and display of voltage, current phase angles and frequency on two or three-phase systems.
- Accurate phase angle measurement at low current levels.
- Easy to use: large bright LCD display and large buttons enable easy handling of the instrument.
- Memory storage for storing up to 1500 measurements.
- Safe: built for CAT II / 600V environments.
- Portable: rugged carrying case with a handle and lightweight design enable easy moving the instrument between sites.
- Built in charger & rechargeable batteries: instrument has a built-in charging circuit and comes with a set of rechargeable NiMH batteries.
- Downloadable: downloads test results via RS232 or USB cable directly to the PC with the help of the Metrel EuroLink software.

APPLICATION:

- VAFMeter instrument is designed to be used in general electrical systems maintenance and commissioning, protective relay testing, electrical machine repairs or in monitoring power at the electrical service entrance.
- For meter installations, unit measures phase-to-phase voltage and single-phase current amplitudes and phase angles.
- Combined with a voltage or current source, instrument also becomes an excellent tool for testing and calibrating virtually any type of protective relay.

STANDARDS:

- Functionality:**
IEC 61000-4-7;
IEC 61557-12
- Electromagnetic compatibility:**
IEC 61326-1; IEC 61326-2-2
- Safety:**
IEC/EN 61010-1

STANDARD SET:

- MI 2230**
- Instrument MI 2230 VAFMeter
 - Test lead 4 x 1.5 m
 - Test probe, 4 pcs
 - A 1395 Flexible current clamps 30/ 300/ 3000 A

- Crocodile clip, 4 pcs
- Set of NiMH battery cells
- Power supply adapter
- Instruction manual
- Calibration Certificate
- CD with instruction manual, PC SW EuroLink
- Set of carrying straps



TECHNICAL SPECIFICATION:

Function	Measuring range	Basic accuracy
Voltage	6 V ... 600 V	\pm (0.5 % of reading + 3 digits)
Current		
A 1398 - 10 A	0.1 A ... 20 A	\pm (1.5 % of reading + 2 digits)
A 1395 - 30 A	3 A ... 30 A	\pm (1.5 % of reading + 2 digits)
A 1395 - 300 A	30 A ... 300 A	\pm (1.5 % of reading + 2 digits)
A 1395 - 3000 A	300 A ... 3000 A	\pm (1.5 % of reading + 2 digits)
Phase angle	-180.0 ... +180.0	\pm 0.5°
Power		
Active	0.000 W ... 9999 kW	\pm (1.5 % of reading. + 4 digits)
Reactive	0.000 VAR ... 9999 kVA	\pm (1.5 % of reading. + 4 digits)
Apparent	0.000 VA ... 9999 kVA	\pm (1.5 % of reading. + 4 digits)
PF	-1.00 ... 1.00	\pm 0.04
Cos ϕ	0.00 ... 1.00	\pm 0.04
THD	0.0 ... 20.0 %	\pm 0.5
	0.0 Ω ... 19.9 Ω	\pm (3 % of reading + 3 digits)
Resistance	20.0 Ω ... 199.9 Ω	\pm (5 % of reading)
	200 Ω ... 1999 Ω	\pm (5 % of reading)
Continuity	0.0 Ω ... 19.9 Ω	\pm (5 % of reading + 3 digits)
	20 Ω ... 1999 Ω	\pm (5 % of reading + 3 digits)

PowerView3

PowerView3 software is a powerful platform for downloading, analysing recorded data and creation of power quality test reports. PC Software contains a package of functionalities needed for profound evaluation of power quality phenomena, data comparison and creation of complex test reports. It works in conjunction with Metrel new generation power quality analysers. For the instruments equipped with GPRS functionality PowerView3 enables remote control of the instrument as well.

KEY FEATURES:

- **User friendly interface:** wide range of quick buttons, possibility to customize the environment by dragging, docking and resizing the window tabs.
- **Structure:** downloaded data is organized into Windows Explorer-like tree structure.
- **“Drag and drop”:** downloaded data can be easily organized into multiple sites and sub-site locations.
- **Data filtering:** data in a structure can be grouped by quantity or by phase.
- **Views:** depending on selected record type, different views are available (Record Information view, Trend Chart view, Table view, Waveform Scope view, Voltage Quality view, etc.)
- **EN 50160 analysis:** automatic voltage quality analysis in compliance with custom or predefined EN 50160 Power Quality criteria and quick report printing.
- **Chart zoom:** chart can be zoomed depending on selected in a table value range.
- **Remote control:** via GPRS communication remote handling of the instrument and its data can be executed.
- **GPS synchronization:** simultaneous measurement on the different network points by using 2 or more synchronized instruments.

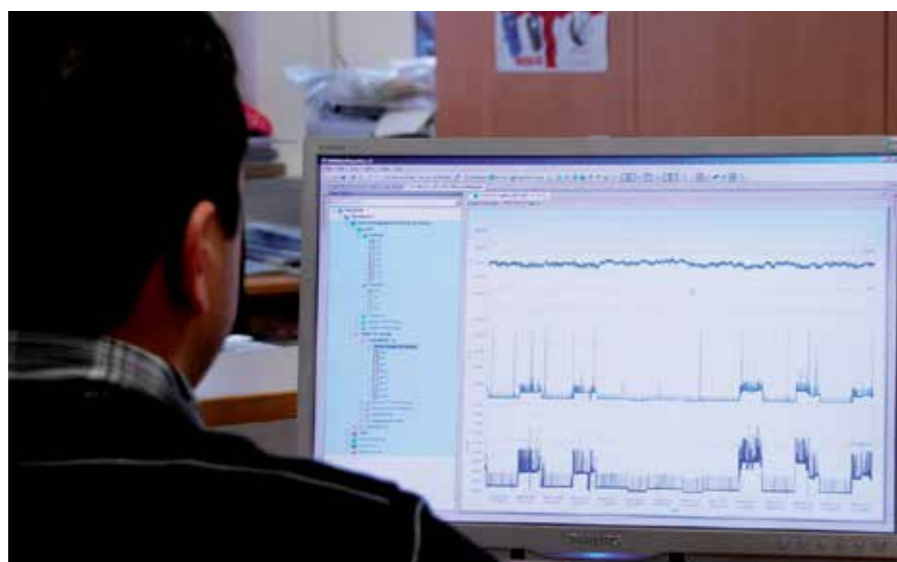

- **On-line monitoring:** when instrument is connected with PC, real-time observing of signals and parameters is possible via PowerView3 while instrument is measuring / recording in the background.
- **Export of test results:** test results can be exported to other programs (MS Excel, MS Word).
- **Reports:** automatic generation of test reports from the selected views and data with attached graphs.

- **SW update:** PowerView3 checks for new versions of the application and downloads updates from the Internet if necessary.

PC SW PowerView3 is compatible with:

- MI 2892 PowerMaster
- MI 2792A PowerQ4 Plus
- MI 2792 PowerQ4 Plus
- MI 2592 PowerQ4
- MI 2392 PowerQ^{PLUS}
- MI 2492 PowerQ
- MI 2130 VoltScanner

Simple interface with tree view organized data structure and possibility to customize the environment in numerous ways by using drag / drop capabilities

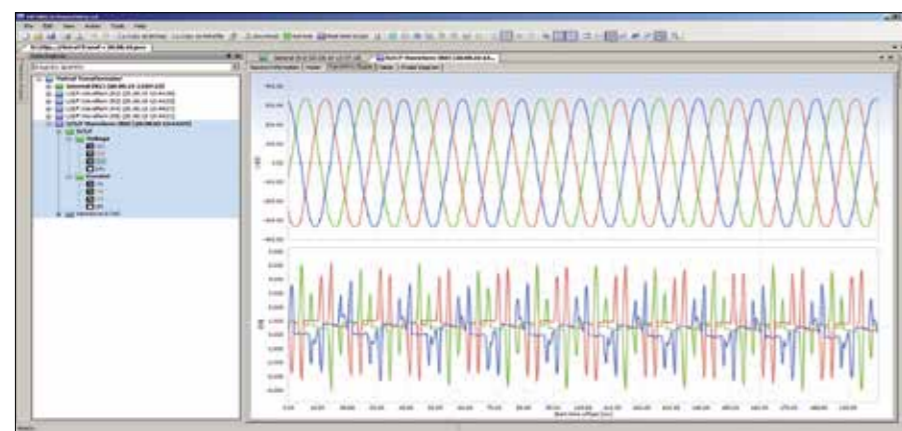
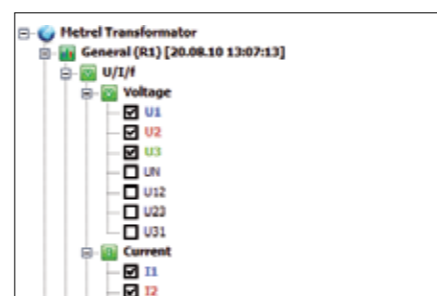

Logged data can be analysed according to custom or predefined EN 50160 Power Quality criteria

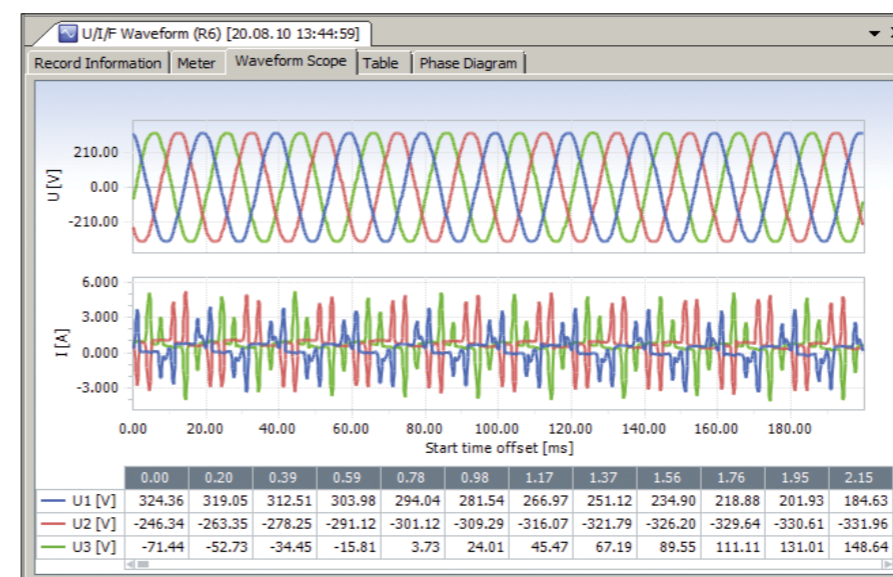
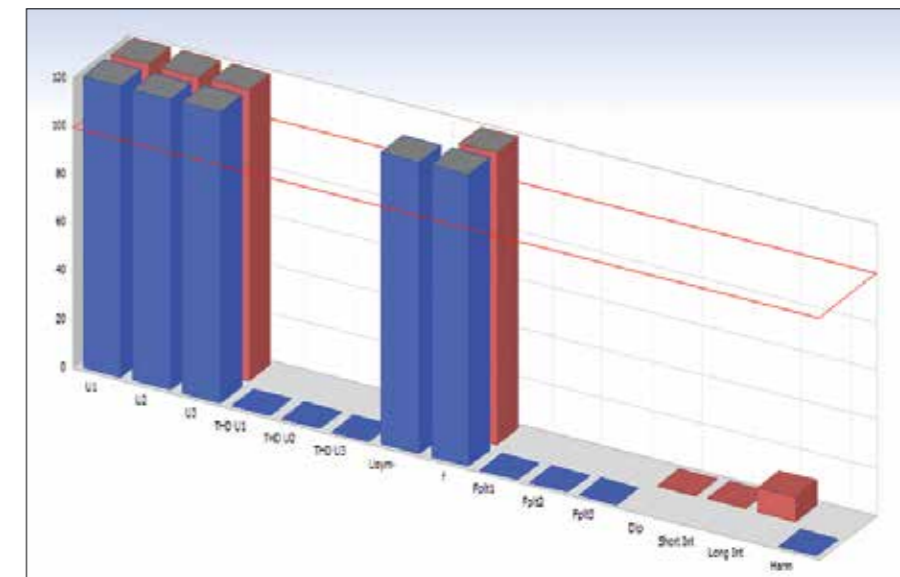
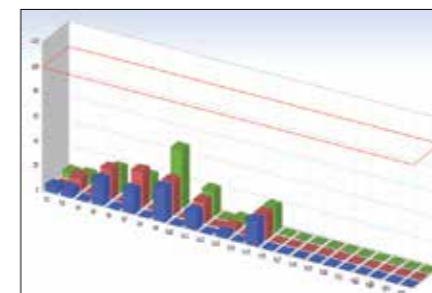

Results can be represented in both trend and table view simultaneously for easier analysis

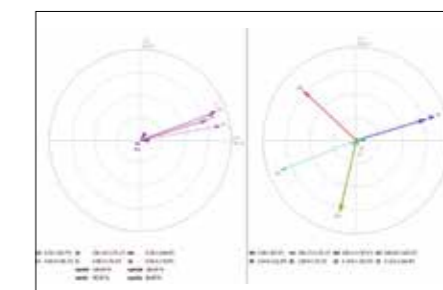

Selected data can be organized into multiple tabs for easier interpretation



Selection Guide for PQA Accessories

Photo	Part number	Description	Target application	MI 2892	MI 2792A	MI 2792	MI 2592	MI 2392	MI 2492	MI 2130	MI 2230
	A 1033	Current clamp 1000 A / 1 V	High accuracy current clamp 1000 A / 1 V with jaw opening 52 mm and fixed 1.5 m cable for power measurements with Metrel power quality analysers.	✓	✓	✓	✓	✓	✓	-	-
	A 1281	Current clamp 0,5/5/100/1000 A / 1 V	Four ranges current clamp for measuring alternating currents in low and medium power installations. Current clamp is automatically recognized by the instrument. Clamp does not require external power supply as it is powered by the instrument.	✓	✓	✓	✓	✓	✓	-	-
	A 1069	Mini current clamp 100 A / 1 V	Mini current clamp 100 A / 1 V with jaw opening 15 mm for power measurements. Requires A 1039 connection cable.	✓	✓	✓	✓	✓	✓	-	-
	A 1122	Mini current clamp 5 A / 1 V	Mini current clamp 5 A / 1 V with jaw opening 15 mm for power measurements. Requires A 1039 connection cable.	✓	✓	✓	✓	✓	✓	-	-
	A 1039	Connection cable for current clamp	Connection cable for connecting current clamps A 1069 and A 1122 on Metrel power quality analysers.	✓	✓	✓	✓	✓	✓	-	-
	A 1179	3-phase flexible current clamp 2000/200/20 A / 1 V	3-phase flexible current clamp with three selectable measuring ranges. Powered by alkaline or rechargeable batteries.	✓	✓	✓	✓	✓	✓	-	-
	A 1227	1-phase flexible current clamp 3000/300/30 A / 1 V	Single phase flexible current clamp with three selectable measuring ranges. Current clamp is automatically recognized by the instrument. Clamp does not require external power supply as it is powered by the measuring instrument.	✓	✓	✓	✓	✓	✓	-	-
	A 1446	1-phase flexible current clamp 6000/600/60 A / 1 V	Single phase flexible current clamp with three selectable measuring ranges. Does not require external power supply as it is powered by the measuring instrument.	✓	✓	✓	✓	✓	✓	-	-
	A 1257	3-phase flexible current clamp 3000/300/30 A / 1 V	3-phase flexible current clamp with three selectable measuring ranges. Powered by alkaline or rechargeable batteries.	✓	✓	✓	✓	✓	✓	-	-
	A 1287	1-phase flexible current clamp 3000/300/30 A / 1 V	Single phase flexible current clamp with three selectable measuring ranges. Powered by alkaline or rechargeable batteries.	✓	✓	✓	✓	✓	✓	-	-
	A 1037	Current transformer 5 A / 1 V	3-phase transformer for power measurements on distribution panels with 5 A nominal output current.	✓	✓	✓	✓	✓	✓	-	-
	A 1355	GPS receiver	GPS Synchronization unit guaranties that the time clock of the Metrel PowerQ4 Plus analyzer is synchronized according to IEC 61000-4-30. This performance is necessary to ensure that instruments produce the same aggregation results when connected to the same signal.	✓	✓	✓	-	-	-	-	-

✓ Option - Not available

Selection Guide for PQA Accessories

Photo	Part number	Description	Target application	MI 2892	MI 2792A	MI 2792	MI 2592	MI 2392	MI 2492	MI 2130	MI 2230
	A 1356	GPRS modem	GPRS modem data transfer enables remote handling of the measuring instrument and its data. If the measuring instrument has to be located on distant or hardly accessible place, the GPRS modem is the only practical solution for fast access to the instrument.	-	✓	✓	-	-	-	-	-
	A 1198	Magnetic contact probe	Test probe with magnetic contact provides reliable contact with metal surface during the measurement.	✓	✓	✓	✓	✓	✓	-	-
	A 1014	Test probe, black	Test probe with Ø 4 mm connection is suitable for performing measurements both in mains outlets and in situations when no schuko outlet is present.	✓	✓	✓	✓	✓	✓	✓	✓
	A 1015	Test probe, blue	Test probe with Ø 4 mm connection is suitable for performing measurements both in mains outlets and in situations when no schuko outlet is present.	-	-	-	-	-	-	✓	-
	A 1016	Test probe, red	Test probe with Ø 4 mm connection is suitable for performing measurements both in mains outlets and in situations when no schuko outlet is present.	✓	✓	✓	✓	✓	✓	-	✓
	A 1062	Test probe, green	Test probe with Ø 4 mm connection is suitable for performing measurements both in mains outlets and in situations when no schuko outlet is present.	-	-	-	-	-	-	✓	-
	A 1013	Crocodile clip, black	Crocodile clip assures secure and permanent contact during the measurement on bus bars, fixing screws, etc.	✓	✓	✓	✓	✓	✓	✓	✓
	A 1310	Crocodile clip, blue	Crocodile clip assures secure and permanent contact during the measurement on bus bars, fixing screws, etc.	-	-	-	-	-	-	✓	-
	A 1064	Crocodile clip, red	Crocodile clip assures secure and permanent contact during the measurement on bus bars, fixing screws, etc.	✓	✓	✓	✓	✓	✓	-	✓
	A 1309	Crocodile clip, green	Crocodile clip assures secure and permanent contact during the measurement on bus bars, fixing screws, etc.	✓	✓	✓	✓	-	-	✓	-
	A 1011	Test lead, 3 x 1.5 m	3-wire test lead for measurements on single or three phase electrical installations.	-	-	-	-	-	-	✓	-
	S 2014	Safety fuse adapter, 3 pcs	Fuse adapters protect the instrument and the user against current strike and overload.	✓	✓	✓	✓	✓	✓	-	-

✓ Option - Not available

Selection Guide for PQA Accessories

Photo	Part number	Description	Target application	MI 2892	MI 2792A	MI 2792	MI 2592	MI 2392	MI 2492	MI 2130	MI 2230
	S 2015	Safety flat clamp, 4 pcs	Safety flat clamps assure good contact when connecting the test leads on busbars and other larger flat surfaces.	✓	✓	✓	✓	✓	✓	-	-
	A 1017	Communication cable RS232	RS232 interface cable for connecting the instrument with the PC.	-	-	-	-	-	-	✓	-
	A 1171	RS232 / USB adapter with 1 m cable	RS232 / USB adapter for instruments without USB communication port.	-	-	-	-	-	-	✓	-
	A 1458	SanDisk microSD card reader	Move data between your computer and memory card with memory card reader.	✓	-	-	-	-	-	-	-
	A 1020	Small soft carrying bag	Small soft carrying bag for transport and storage of test instrument or accessories.	✓	✓	✓	✓	✓	✓	-	-
	A 1006	Soft carrying bag	Large soft carrying bag for transport and storage of test instrument and belonging accessories.	✓	✓	✓	✓	✓	✓	-	-
	A 1083	Power supply adapter with 6 pcs NiMH batteries, type AA	Battery charger and a set of 6 pieces of rechargeable batteries, type AA.	✓	✓	✓	✓	✓	✓	-	✓
	A 1160	Fast charger for 8 AA batteries with a set of 6 NiMH bat., type AA	Fast battery charger for up to 8 pieces of AA rechargeable batteries, and a set of 6 pcs NiMH rechargeable batteries, type AA.	✓	✓	✓	✓	✓	✓	✓	✓
	A 1169	Fast charger for AA, C, D and 9 V block batteries	Fast battery charger for up to 12 pcs AA, 6 pcs C or D rechargeable batteries, 4 pcs 9 V block batteries.	✓	✓	✓	✓	✓	✓	✓	✓

✓ Option - Not available

Accessories: page 4.24

MEASURING INSTRUMENTS AND TESTERS

- Electrical Installation Safety
- High Voltage Insulation / Continuity / Earth
- Appliance / Machine / Switchboard Safety
- Power Quality Analysis
- LAN Cabling Certification
- Indoor Environment Quality
- Digital Multimeters / Clamp Meters / Voltage and Continuity Testers
- Variable transformers / Equipment for laboratories and Schools

GOOD TO KNOW

LAN Cabling Certification	5	-	02
Selection Guide for LAN Testers	5	-	03
MI 2016 Multi LAN 350	5	-	04
MI 2014 Cable Scanner	5	-	06

PC SOFTWARE

LAN Link	5	-	07
Selection Guide for LAN Accessories	5	-	08

LAN Cabling Certification
Computer Network Cable Testers and Certifiers

LAN Cabling Certification

Find out more about LAN installations testing.

Constant development of IT systems requires higher data transmission capabilities of computer networks. Accordingly these have to be designed and constructed in such a way to meet the latest requirements which assure long-term usability and expandability of cooper and optic fibre cabling.

Testing of structured LAN cabling is an essential part of certification and maintenance of LAN networks and assures that all built-in components comply with proposed regulation.

Typical termination failures:

- Broken or open wire;
- Short circuit to shield;
- Short circuit between wires;
- Crossed, reversed and transposed pairs);
- Split pairs;
- Other termination problems.

These type of failures can be easily found with simple test devices called wire-mapper.

Hidden failures

Proper termination does not necessarily guarantee proper functioning of cabling system. Certain failures can only be found at high data transmission level or higher operating frequencies. These limit conditions may create signal reflections or interferences in adjacent pairs or cables. A common source of such problems are installed network components like sockets and plugs that in combination with built-in termination failures contribute to data transmission problems.

Such failures can be easily found with advanced LAN testers that do not only check wiring but also measure a number of other electrical parameters in a wide frequency bandwidth.

Regulations and standards

Specification of LAN certifying testers, their measuring accuracy, presentation form of test results and their limit values have been defined in various standards. In EU countries it is common that national legislations refer to the EN 50173, while globally IEC 11801 is being used with the TIA 568B specified in the US.

For high capacity LAN networks in class 6 and higher both, Permanent and Channel link are being tested which urges for high quality test adapters. Regular checking of test equipment which may include calibration is necessary to assure reliable test results.

Measured parameters:

Wire map

Wire Map test verifies the pin to pin wiring and shield continuity.

METREL's hint:

Split pairs cannot be found with simple continuity checks. They are detected with a simplified NEXT measurement. The reason for high crosstalk is not necessarily a split pair - unsuitable and careless assembled connectors or cable faults can also cause a split pair warning. The real error source can be easily defined with the TDCross function. The point of error can be easily found by using the TDR function. At least one pair must be connected properly to assure correct operation of the instrument.

PSNEXT, Remote PSNEXT

PSNEXT (Power Sum Near End Crosstalk) defines the coupling on one cable pair from all other pairs. The PSNEXT is calculated from individual NEXT results and represents the expected worst case coupling. Similar to NEXT the coupled signal from other pairs can cause data corruption, retransmissions and other problems. This is especially critical in multi-pair data protocols.

NEXT, Remote NEXT

NEXT (near end crosstalk) defines the coupling between adjacent pairs. High level signals transmitted in one pair on a cable end can induce a substantial disturbance signal in the neighboring pairs, on the same (transmitter) side. This signal added to the signals transmitted from the other cable can cause data corruption, retransmissions and other problems. The most common causes for NEXT problems are poor twisting on connector points, non matched connection components, split pairs etc.

ELFEXT, Remote ELFEXT

FEXT (Far End Crosstalk) defines crosstalk caused by the coupling of a signal from a pair transmitted on one cable side

into an adjacent pair with the receiver on the other side.

ELFEXT (Equivalent Level Far End Crosstalk) is calculated from FEXT and the attenuation on the receiver pair.

The main result is given as the worst case margin in dB to the test standard limit. High ELFEXT causes typical crosstalk problems: data corruption, retransmissions etc.

PSELFEXT, Remote PSELFEXT

PSFEXT (Power Sum Far End Crosstalk) defines crosstalk caused by the coupling of signals into a cable pair from other pairs. The receiver of crosstalk signals is on one cable side and the transmitters on the other cable side on another pair. PSELFEXT (Power Sum Equivalent Level Far End Crosstalk) is calculated from PSFEXT and the attenuation on the receiver pair.

High PSELFEXT's cause typical crosstalk problems: data corruption, retransmissions, etc.

RETURN LOSS, Remote RETURN LOSS

Return loss is the ratio between transmitted and reflected signals at the transmission end. High return loss rates are often caused by local impedance mismatching and decrease the signal strength on the receiver end.

Attenuation

Attenuation is the measured loss of signal strength in a pair from one cable end to the other. It increases with frequency and cable length so it has to be measured over the complete frequency range. Attenuation is one of the main cable parameters that dramatically influences the maximum bit rate of data stream allowed.

PSACR, Remote PSACR

PSACR (Attenuation to crosstalk ratio) is a comparison of the attenuated regular signal and disturbing crosstalk signals from other pairs on the receiver side. PSACR is computed from Attenuation and PSNEXT.

$$PSACR(f) = PSNEXT(f) - Attenuation(f)$$

PSACR results consider Attenuation and PSNEXT. It is taken in account that at shorter cables the PSNEXT could be higher without degradation of the link performance. Therefore it is very suitable

Selection Guide for LAN Testers

ble for the estimation whether the crosstalk's are critical or not.

ACR, Remote ACR

ACR (Attenuation to crosstalk ratio) is a comparison of the attenuated regular signal and disturbing crosstalk signals on the receiver side. High ACR values indicate a high performance connection where the crosstalk levels are small in comparison with attenuation. ACR is computed from Attenuation and NEXT.

$$ACR(f) = NEXT(f) - Attenuation(f)$$

The ACR results consider Attenuation and NEXT. It is taken in account that at shorter cables the NEXT could be higher without degradation of the link performance. Therefore ACR is very suitable for the estimation whether the crosstalk's are critical or not.

Length

The length test measures the length of each cable pair.

The cable length is determined from the time it takes for a pulse to travel along the cable. To get the right result the pulse propagation speed has to be known. The NVP factors can be set (nominal velocity propagation factor, given by percents of light speed) for cables in the Cable Type Menu. Since they aren't exactly defined from the manufacturer (variations can occur through ageing, different materials, temperature, number of twists etc) the length results are only indicative. The problem intensifies at longer lengths.

Delay Skew

Delay skew is the difference in propagation delays between test pulses through different cable pairs. The shortest delay is referenced to 0ns. High delay skews can cause trouble especially when fast multi-pair data protocols are used.

Propagation Delay

Propagation delay is the time it takes a test pulse to travel the length of each cable pair.

Impedance

Impedance is a characteristic of the cable. In general the characteristic impedances in high frequency systems must be matched to ensure a regular data flow. Every change in impedance

along the link will cause a reflection and decrease the signal strength on the receiver end. A change in impedance can occur if using improper cables, cable components or the cable is damaged.

DC Resistance

DC resistance test verifies that the loop resistances (sum of resistances of both wires) in individual pairs are within the given limits.

Additional recommendations

Additional to the measurements de-

finied by standards there are some other measurements that may help at analysing network conditions and failure finding. TDR (time domain reflectometer) is one of such tools which is frequently being used to find a faulty spot along the LAN cable. Test signal is sent along the tested cable and based on its reflection strength and reflection time a distance to the faulty spot is calculated.

Another test function TD NEXT measures a distance with the highest crosstalk along the tested cable.

Part No.:	MI 2016 Multi LAN 350	MI 2014 Cable Scanner
TEST FUNCTIONS		
Wiremap	✓	✓
NEXT / Remote NEXT	✓ / ✓	-
PSNEXT / Remote PSNEXT	✓ / ✓	-
ELFEXT / PSELFEXT	✓ / ✓	-
Return Loss / Remote Return Loss	✓ / ✓	-
ACR / Remote ACR	✓ / ✓	-
PSACR / Remote PSACR	✓ / ✓	-
Length	✓	✓
Propagation delay	✓	-
Delay skew	✓	-
Impedance	✓	-
DC resistance	✓	-
Attenuation	✓	-
TDR	✓	✓
TDR with TDnext	✓	✓
FEATURES		
Frequency range	0 ... 350 MHz	-
CAT 6	✓	-
CAT 5 / 5e	✓ / ✓	✓ / ✓
Coax cable	-	✓
Internal memory	✓	-
Cable tracer option	✓	-
PC Software	✓	-
RS232 port and cable	✓	-
USB port and cable	✓	-
Talk over copper (Talk set)	✓	✓
Cable identifiers	✓	✓
RJ 45 output	✓	✓
BNC output	-	✓
GENERAL DATA		
Dimensions	265 x 110 x 185 mm	156 x 100 x 190 mm
Weight	2.1 kg	1 kg

MI 2016 Multi LAN 350

The MI 2016 Multi LAN 350 is a high quality measuring instrument for LAN cabling verification up to CAT 6 / Class E according to international standards EN 50173, TIA/EIA 658B, ISO/IEC 11801, etc. The seamless execution of complete autotest with Pass / Fail evaluation of results can be performed within 55 seconds. The built-in intercom system allows easy communication through the length of the cabling. The autosequence mode and single test mode (useful in troubleshooting), large graphical LCD with backlight, help screens and PC software as standard accessory make LAN testing with MI 2016 simple, easy and comprehensive.

MEASURING FUNCTIONS:

- Cable length;
- Propagation delay;
- Delay skew;
- Characteristic Impedance;
- DC resistance;
- Attenuation;
- NEXT, Remote NEXT;
- PSNEXT, Remote PSNEXT;
- ELFEXT, Remote ELFEXT;
- PSELFEXT;
- Return loss, REMOTE Return loss;
- ACR, Remote ACR;
- PSACR, Remote PSACR;
- TDR (Time Domain Reflectometer);
- Time Domain Crosstalk;
- Wire map test.

KEY FEATURES:

- Top class CAT 6 / Class E LAN certification tester for testing high speed networks with a test frequency up to 350 MHz.
- Extensive database of Autotests for complete and quick LAN cabling verification in accordance with all leading test standards.
- Instrument supports UTP, STP, ScTP and FTP cables testing.
- Adapters included in the standard set enables both Channel and Permanent Link connection.
- High resolution TDR with TDnext functions for quick determination of a distance to a faulty point along the cable.
- LAN Link PC software package included in the standard set enables analysis of test data and test report creation.
- PASS / FAIL evaluation of test results according to selected test standard.
- Graphical representation of test results on instrument's display.

APPLICATION:

- Verification of LAN networks up to CAT 6 / Class E;
- Troubleshooting in IT networks.



KEY FEATURES

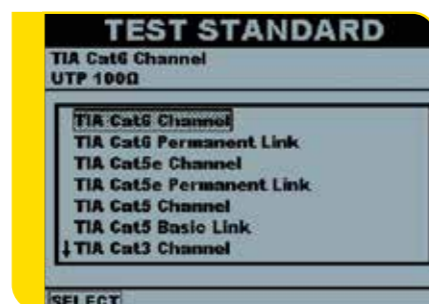

Selectable test standards for complete and quick LAN cabling verification.

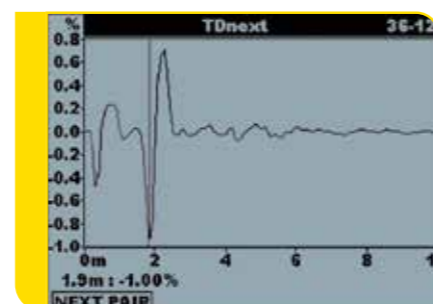

TDNext function for determination of faulty points.

STANDARDS:

Functionality: TIA/EIA 568B Cat 3, Cat 5, Cat 5 E, Cat 6; ISO 11801; EN 50173
Safety: IEC/EN 611010-1; IEC 60825-1

TECHNICAL SPECIFICATION:

Function	Measuring range	Resolution	Accuracy
Length	0.0 ... 99.9 m	0.1 m	±(3 % of reading + 5 digits)
	100 ... 300 m	1 m	±4 % of reading
Propagation delay	0 ... 500 ns	1 ns	±(3 % of reading + 5 digits)
	501 ... 4000 ns	1 ns	±3 % of reading
Delay skew	0 ... 500 ns	1 ns	±10 digits
Characteristic Impedance	35 ... 180 Ω	1 Ω	±(10 % of reading + 3 digits)
DC Resistance	0.0 ... 199.9 Ω	0.1 Ω	±(10 % of reading + 5 digits)
Attenuation			
- Frequency	1 MHz ... 250 MHz	1 MHz	According to TIA/EIA 568-B.2
- Amplitude	0.0 ... 60.0 dB	0.1 dB	
NEXT, Remote NEXT			
- Frequency	1 MHz ... 350 MHz	0.15 MHz	According to TIA/EIA 568-B.2
- Amplitude	0.0 ... 90.0 dB	0.1 dB	
PSNEXT, Remote PSNEXT			
- Frequency	1 MHz ... 350 MHz	0.15 MHz	According to TIA/EIA 568-B.2
- Amplitude	0.0 ... 90.0 dB	0.1 dB	
ELFEXT, Remote ELFEXT			
- Frequency	1 MHz ... 350 MHz	0.15 MHz	According to TIA/EIA 568-B.2
- Amplitude	0.0 ... 90.0 dB	0.1 dB	
PSELFEXT			
- Frequency	1 MHz ... 350 MHz	0.15 MHz	According to TIA/EIA 568-B.2
- Amplitude	0.0 ... 70.0 dB	0.1 dB	
Return Loss, Remote Return Loss			
- Frequency	1 MHz ... 350 MHz	0.15 MHz	According to TIA/EIA 568-B.2
- Amplitude	0.0 ... 40.0 dB	0.1 dB	
Time Domain Reflectometer (TDR)			
		at NVP=0.69-c:	
- Distance / Pulse length	0 ... 10 (50, 100) m	1 ns, 0.1 m	±(3 % of reading + 5 digits)
	0 ... 200 m	2 ns, 0.2 m	±5 % of reading
	0 ... 400 m	4 ns, 0.4 m	±5 % of reading
- Amplitude	in percents	1 %	
- Selectable propagation velocity rate	0.50 c ... 0.99 c		
Time Domain Crosstalk			
- Distance / Pulse length	0 ... 10 (50, 100) m	1 ns, 0.1 m	±(3 % of reading + 5 digits)
	0 ... 200 m	20 ns, 0.2 m	±5 % of reading
- Amplitude	in percents	0.1 %	
General			
COM port	RS232 and USB		
Display	Graphic LCD, 320 x 240 dots, with backlight		
Power supply	6 x 1.2 rechargeable batteries, type C		
Dimensions	265 x 110 x 185 mm		
Weight	2.1 kg		

STANDARD SET:

- MI 2016ST**
- Instrument Multi LAN 350
 - Remote unit Multi LAN 350
 - Permanent Link adapter, 2 pcs
 - Channel Link adapter, 2 pcs
 - Locators (#1 ... #4), 4 pcs
 - Attenuation calibration module
 - Power supply adapter, 2 pcs
 - Headphones set, 2 pcs
 - Carrying bag, 2 pcs
 - PC SW LAN Link with USB and RS232 cables

- 12 x 1.5 V NiMH rechargeable batteries, type C
- Instruction manual
- Calibration certificate

- MI 2016PS**
- MI 2016ST
 - Remote unit Multi LAN 350 is replaced by Instrument Multi LAN 350



MI 2014 Cable Scanner

MEASURING FUNCTIONS:

- Cable length;
- TDR (Time Domain Reflectometer);
- Time Domain Crosstalk;
- Wire map test.

KEY FEATURES:

- Fast termination fault finding with graphical indication of the failure type.
- Integrated high accuracy TDR function with adjustable NVP factor measures distance to the fault.
- Internal tone generator combined with an optional Cable tracer serves for wire finding in bounces of cables.
- Locators for simplified identification of sockets are included in a standard set.
- Optional Talk Remote Unit allows voice communication over the tested cable.
- Instrument's outputs allow testing on RJ 45 and coax terminations.

APPLICATION:

- Troubleshooting and maintenance of LAN and other cable networks.

STANDARDS:

Electromagnetic compatibility:
EN 50081-1;
EN 50882-1
Safety:
EN 611010-1

STANDARD SET:

- MI 2014**
- Instrument Cable Scanner
 - Cat 5 Patch cable, 2 pcs
 - Standard Remote #1
 - Locators (#1 ... #4), 4 pcs
 - Instruction manual
 - Calibration certificate



The MI 2014 Cable Scanner is a portable handheld battery powered instrument intended for testing LAN installations and cables. This simple but effective device performs copper terminations testing on shielded and unshielded LAN and coax cables. With optional Tracer can be performed tracing of cables and wires. Talk function enables full duplex communication between remote operators. Due to user friendly interface handling of the instrument is simple and clear.



TECHNICAL SPECIFICATION:

Function	Measuring range	Resolution	Accuracy
Twisted Pair cable / Length and Reflections			
- Distance	0.0 ... 99.9 m	0.1 m	±(3% of readings + 5 digits)
	100 ... 300 m	1 m	±(5% of readings + 1 digits)
- Amplitude	-99 % ... 100 %	1 %	±(5% of readings + 5 digits)
Coax cable / Length and Reflections			
- Distance	0.0 ... 99.9 m	0.1 m	±(3% of readings + 5 digits)
	100 ... 300 m	1 m	± 5% of readings
- Amplitude	-99 % ... 100 %	1 %	±(5% of readings + 5 digits)
Power supply	6 x 1.5 V alkaline or 6 x 1.2 V rechargeable batteries, type AA		
Dimensions	156 x 100 x 190 mm		
Weight	1 kg		

LAN Link

The LAN Link software enables downloading, analysing of stored data and transferring latest observed cable characteristics for detailed further research on LAN and Telecommunication Cable Installations.

KEY FEATURES:

- **User friendly interface:** wide range of quick icons, for downloading, exporting, viewing and reorganizing data.
- **Downloading Autotest results or Plots:** After connecting the Multi LAN 350 to a PC stored Autotest Results or memorized Plots can be downloaded.
- **Structure organized data:** downloaded data are organized into tree structure where the locations could be renamed and / or equipped with comments. Separate Object, Floor or Cable location number could be changed to any alphanumeric name.
- **Creating test Reports:** automatic generation of test reports from the selected views and data with attached graphs. The Operator/Test site menu enabling the operator to create his own Test Report Header and Footer. BMP logo can be added.
- **Comments menu:** any text can be added to the Test Report Header.
- **Evaluation and printout of three different levels of Test Reports:**
- Full Detail Report provides the most complete information about the performed measurements including Pass/Fail decision for performed measurements, overall headroom results or margins for individual pairs.
- Medium Detail Report shows Pass/Fail decision for performed measurements and the overall headroom for individual cables are displayed.
- Low Detail Report enables you to make a clear and simple Test Report providing essential information of the overall Pass/Fail decision and headroom for individual cables.



- **Export of test results:** test results can be exported to other programs (MS Excel, MS Word).
- **Viewing Plots:** Graphs and plots of NEXT, ELFEXT, PSNEXT, PSELFEXT, Attenuation, Return Loss, ACR, PSACR, TDR and TDnext can be downloaded, viewed and printed. The plots contain additional information about Test Standard and Cable Type, date & time of measurement etc.

- PC SW LAN Link is compatible with:**
- MI 2016 Multi LAN 300

After connecting the Multi LAN 350 to a PC stored Autotest Results or memorized Plots can be downloaded.

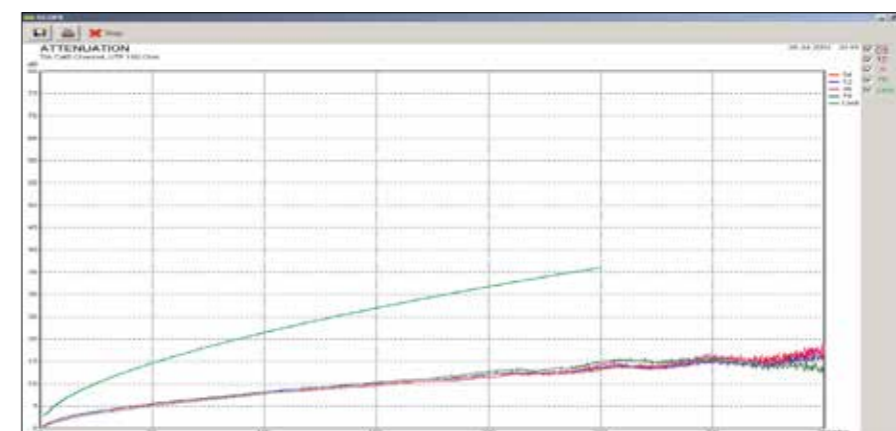

Frequency (MHz)	Attenuation (dB)	Pass/Fail
0.1	0.0	PASS
0.2	0.0	PASS
0.5	0.0	PASS
1.0	0.0	PASS
2.0	0.0	PASS
5.0	0.0	PASS
10.0	0.0	PASS
20.0	0.0	PASS
50.0	0.0	PASS
100.0	0.0	PASS
200.0	0.0	PASS
500.0	0.0	PASS
1000.0	0.0	PASS
2000.0	0.0	PASS
5000.0	0.0	PASS
10000.0	0.0	PASS

Selection Guide for LAN Accessories

Photo	Part number	Description	Target application	MI 2016	MI 2014
	A 1006	Soft carrying bag	Large soft carrying bag for transport and storage of test instrument and belonging accessories.	✓	✓
	A 1007	Carrying strap	Carrying strap for carrying the measuring instrument around the neck allowing free hand use of the tester.	-	✓
	A 1041	Headphones with microphone, 2 pcs	Talk set with two earphones allows communication over the tested communication cable.	✓	✓
	A 1043	Locator set II (#5 to #16)	Locators simplify and accelerate numerification and identification of LAN sockets. Set includes locators with number from #5 up to #16.	✓	✓
	A 1044	Locator set III (#17 to #28)	Locators simplify and accelerate numerification and identification of LAN sockets. Transponders with numbers from #17 up to #28 are delivered with the set.	✓	✓
	A 1046	1.2 V NiMH battery, type C, 6 pcs	A set of 6 pieces of rechargeable batteries, type C.	✓	-
	A 1082	Cable tracer	Cable tracer is intended for wire tracing on dead or live low voltage installations. To be used with MI 2014.	-	✓
	A 1083	Power supply adapter with 6 pcs NiMH batteries, type AA	Battery charger and a set of 6 pieces of rechargeable batteries, type AA.	-	✓
	A 1169	Fast charger for AA, C, D and 9 V block batteries	Fast battery charger for up to 12 pcs AA, 6 pcs C or D rechargeable batteries, 4 pcs 9 V block batteries.	✓	✓
	S 2004	Talk remote unit with headphones set	Talk set includes Talk remote unit and two earphones and enables communication over the tested computer or phone line. To be used with MI 2014.	-	✓
	S 2005	Standard remote set (#2 ... #6)	Standard remote set contains a package of locators with numbers from #2 up to #6 for detailed measurements on communication connections and identification of sockets. To be used with MI 2014.	-	✓
	S 2006	Standard remote set (#7 ... #15)	Standard remote set contains a package of locators with numbers from #7 up to #15 for detailed measurements on communication connections and identification of sockets. To be used with MI 2014.	-	✓

✓ Option - Not available

MEASURING INSTRUMENTS AND TESTERS

- Electrical Installation Safety
- High Voltage Insulation / Continuity / Earth
- Appliance / Machine / Switchboard Safety
- Power Quality Analysis
- LAN Cabling Certification
- **Indoor Environment Quality**
- Digital Multimeters / Clamp Meters / Voltage and Continuity Testers
- Variable transformers / Equipment for laboratories and Schools

GOOD TO KNOW

Indoor Environment Quality	6	-	02
Selection Guide for Indoor Environment Quality Analysers	6	-	04
MI 6201 Multinorm	6	-	06
MI 6301 FonS	6	-	08
MI 6401 Poly	6	-	10
PC SOFTWARE			
SensorLink	6	-	12
SoundLink	6	-	13
Selection Guide for IEQ Accessories	6	-	14

Indoor Environment Quality

Find out more about Indoor Environment Quality parameters testing

Indoor Environmental Quality (IEQ) encompasses all aspects of the indoor setting including air quality, ventilation, thermal comfort, lighting and noise.

Indoor air quality (IAQ) refers to the quality of the air inside buildings as represented by concentrations of pollutants and the thermal (temperature and relative humidity) conditions that affect the health, comfort, and performance of occupants. Other factors affecting occupants, such as light and noise, are important indoor environmental quality considerations.

Poor indoor air quality can lead to a number of physical symptoms and complaints like headaches, fatigue, shortness of breath, sinus congestion, coughs, sneezing, eye, nose, and throat irritation, skin irritation, dizziness, nausea, etc.

A healthy and comfortable indoor environment relies on a correct combination of temperature, humidity, air movement and task lighting.

Measurements that can be performed with Metrel IEQ instruments:

- Air Temperature (°C)
- Thermocouple Temperature (°C)
- Temperature Difference (°C)
- Relative Humidity (%)
- Dew Point (°C)
- Natural Wet Bulb Temp. (°C)
- Black Globe Radiant Temperature (°C)
- WBGT Index (°C)
- Air Velocity (m/s)
- Air Flow (m³/h)
- PMV Index
- PPD Index (%)
- Illuminance (Lux)
- Luminance (cd/m²)
- Contrast
- CO Concentration (ppm)
- CO₂ Concentration (ppm)
- Sound level (dB)
- 1/1 Octave Analysis
- 1/3 Octave Analysis

IAQ parameters

Air Temperature (°C)

Temperature is the degree of hotness or coldness of a body or environment.

Thermocouple Temperature (°C), Temperature Difference (°C)

Thermocouple is a device for accurate wide range measurement of temperature. It consists of two wires of different metals joined at each end. One junction is placed where the temperature is to be measured, and the other is kept at a constant lower (reference) temperature. Since voltage changes in proportion to temperature (41 μV/°C), the measured voltage difference indicates temperature differences.

If the thermocouple probe is connected to the instrument the temperature difference between measured thermocouple temperature and air temperature is calculated:

$$\Delta T = T_c - T$$

ΔT - temperature difference;
T_c - thermocouple temperature;
T - air temperature.

Relative Humidity (%)

Relative humidity is a term used to describe the ratio of the amount of water vapor in the air at a specific temperature to the maximum amount that the air could hold at that temperature.

The two most common electronic sensors are used to measure humidity: capacitive or resistive. The capacitive sensors sense water by applying an AC signal between two plates and measuring the change in capacitance caused by the amount of water present.

Dew Point (°C)

The dew point is the temperature at which air becomes saturated when cooled without addition of moisture or change of pressure. Any further cooling causes condensation, fog and dew are formed in this way.

Dew point is calculated from air temperature and relative humidity, so for accurate measurement the longer exposition time of air temperature or relative humidity measurements should be considered.

Natural Wet Bulb Temperature (°C)

Natural Wet Bulb temperature is indicated

by a moistened thermometer bulb exposed to the air flow.

Wet bulb temperature can be calculated or measured using a thermometer with the bulb wrapped in wet muslin. A wet bulb thermometer measures the extent of cooling as moisture dries from a surface (evaporative cooling). The wet bulb temperature is always lower than the dry bulb temperature except when there is 100% relative humidity.

Black Globe Radiant Temperature (°C)

Black Globe Radiant Temperature is amount of heat accepted by the body due to the radiation of either direct light or hot objects in the environment.

For instance, if the sun is setting, turning to night, you may feel a coolness, although the temperature is unchanged at that moment.

WBGT Index (°C)

WBGT (Wet Bulb Globe Temperature) index is composite temperature used to estimate the effect of temperature, humidity, and solar radiation on humans. It is used by industrial hygienists, athletes, and the military to determine appropriate exposure levels to high temperatures.

The WBGT index is the most widely used heat stress index and is standardized in ISO 7243. Metrel instruments supports automatic indoor WBGT index calculation:

$$WBGT \text{ (indoor)} = 0.7 * T_{WB} + 0.3 * T_G$$

T_{WB} – Natural wet bulb temperature;
T_G – Black globe temperature.

Air Velocity (m/s)

Velocity is distance travelled per unit of time, usually it is expressed in meter per second (m/s). Air Velocity is measured with hot wire anemometer.

Air Flow (m³/h)

By multiplying air velocity by the cross section area of a duct, the air volume flowing past a point in the duct per unit of time can be determined; unit is usually cubic meter per hour (m³/h).

PMV Index

PMV (Predicted Mean Vote) is an index, which predicts the mean value of the

Indoor Environment Quality

votes of a large group of persons. PMV index is calculated automatically by Metrel instruments from the inputs of air temperature, mean radiant temperature, relative humidity, air velocity, clothing thermal resistance and metabolic rate.

The PMV index should be in the boundaries from -0.7 to 0.7 for acceptable thermal environment in indoor places.

PMV value	Thermal sensation scale
3 to 2	hot
2 to 1	warm
1 to 0.7	slightly warm
0.7 to 0.7	neutral
-0.7 to -1	slightly cold
-1 to -2	cool
-2 to -3	cold

PMV values

PPD Index (%)

PPD (Predicted Percentage of Dissatisfied) is an index that predicts the number of thermally dissatisfied persons among a large group of people.

The PPD index should be less than 15 % for acceptable thermal environment in indoor places.

The PPD index is automatically shown by Metrel instruments.

Illuminance (Lux)

Illuminance is a term expressing the density of luminous flux incident on a surface:

$$E = dF / dA,$$

where A is the area of the illuminated surface and F is the luminous flux.

Common levels of Illuminance in various conditions:

Lumens per Square Meter (lm/m ² or lux)	
Sunlight alone (maximum)	102.000
Television stage	25.000
Skylight alone (maximum)	16.000
Dull day	1.000
Merchandise display indoors	1.000
Recommended for reading	500
Public areas in buildings	300
Moonlight	0.4
Starlight	0.002

Luminance (cd/m²)

Luminance is the amount of visible light

leaving a point on a surface in a given direction, the unit of measurement is candelas per square meter (cd/m²).

Luminance indicates how much luminous power will be perceived by an eye looking at the surface from a particular angle of view.

Luminance probe measures luminance of different surfaces. The silicon photocell measures light received by the lens; acceptance angle is 3.5°.

Diameters of measuring area for different probe-surface distances:

Probe to surface distance (m)	Diameter of measuring area (mm)
0.75	46
1	61
2	122
3	185
4	245
5	305
6	365
7	430

Contrast

Contrast is difference in the color and brightness of the object and other objects within the same field of view.

CO Concentration (ppm)

Carbon monoxide is one of the most acutely toxic indoor air contaminants, it is colourless, odourless, tasteless, highly poisonous gas. CO is a by-product of incomplete combustion of fossil fuels. Common sources of carbon monoxide are tobacco smoke, space heaters using fossil fuels, defective central heating furnaces and automobile exhaust. By depriving the brain of oxygen, high levels of carbon monoxide can lead to nausea, unconsciousness and death.

CO acceptable levels:

Averaging Times	Maximum Desirable Level	Maximum Acceptable Level	Maximum Tolerable Level
1 hour	13 ppm	30 ppm	n/a
8 hours	5 ppm	13 ppm	17,4 ppm

CO₂ Concentration (ppm)

Carbon dioxide is a colourless, odourless, tasteless, incombustible and "non-toxic" gas, about 1.5 times as heavy

as air, which is indoor mainly produced by humans. It becomes toxic in higher concentrations. 1% (10,000 ppm) concentration will make some people feel drowsy, concentrations of 7% to 10% cause dizziness, headache, visual and hearing dysfunction, and unconsciousness within a few minutes to an hour.

Recommended level is not more than about 700 ppm over outdoor ambient (1,000 ppm equals 0.1 %).

Sound parameters

Sound is a disturbance of mechanical energy that propagates through matter as a wave. Sound is characterized by the properties of sound waves, which are frequency, wavelength, period, amplitude and velocity or speed.

Sound pressure is the pressure deviation from the local ambient pressure caused by a sound wave.

As the human ear can detect sounds with a very wide range of amplitudes, sound pressure is often measured as a sound level on a logarithmic decibel scale (dB).

Sound level (dB)

Since the human ear does not have a flat spectral response, sound levels are often frequency weighted so that the measured level will match perceived levels more closely.

- A-weighting attempts to match the response of the human ear to noise level is dB(A).
- C-weighting is used to measure peak levels.

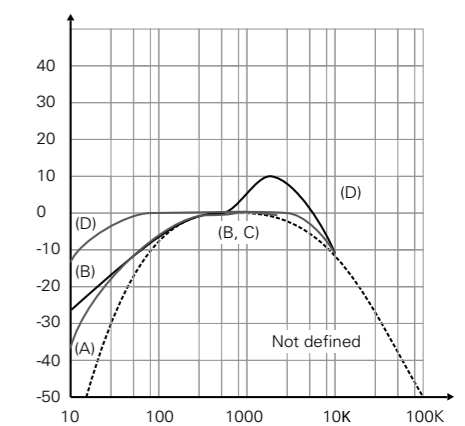

Indoor Environment Quality

1/1 and 1/3 Octave Analysis

Octave is an interval between two sounds having a ratio of two to one in terms of their frequency span. For example, 200 Hz is an octave higher than 100 Hz; 400 Hz is one octave higher than 200 Hz.

Octave bands are classified according to their geometric centre frequency based on the internationally standardized 1000 starting point. The 1000 Hz or 1 kHz band has limits of about 707 and 1414 Hz.

Frequency analysis mode (1/1 and/or 1/3 octave analysis) is usually used if there is a need to improve acoustic properties of a room or working place. The results of frequency analysis show in which part of the acoustic spectrum noise originates, and which frequency components should thus be attenuated.

1/1 Octave Analysis

Frequency bar graph with 9 bars representing nine octave bands from 31 Hz

to 8000 Hz and broadband bar graph for broadband measurements: 31-62-125-250-500-1000-2000-4000-8000.

1/3 Octave Analysis

Frequency bar graph with 27 bars representing 27 one-third octave bands from 25 Hz to 10000 Hz and broadband bar graph for broadband measurement: 25-31-40-50-62-80-100-125-160-200-250-315-400-500-630-800-1000-1250-1600-2000-2500-3150-4000-5000-6300-8000-10000

Class 1 / Class 2

Sound measuring instruments, processors and probes are classified as being Class 1 or Class 2 according to the measurement accuracy achieved. A class 1 instrument may only be formed by combining a class 1 probe with a class 1 processor. Class 1 processor shall, at least, cover the range from 45 Hz to 7.1 kHz in one third octave bands. Class 2 processor shall, at least, cover the same range, or 45 Hz to 5,6 kHz in octave bands, as specified in ISO 9614.



Part No.:
MEASUREMENTS
Air Velocity
Air Flow
Relative Humidity
Dew point
Air teperature
Temperature difference
K Thermocouple temperature
Illuminance
Luminance
Contrast
Black globe radiant temperature
CO concentration
CO ₂ concentration
Sound level, class 1 (IEC 1672)
Sound level, class 2 (IEC 1672)
Real time 1/1 octave analysis
Real time 1/3 octave analysis
TEST PROBES
A 1091 Microclimatic probe
A 1127 Humidity and temperature probe
A 1092 Illuminance probe, type B
A 1132 Luminance probe
A 1128 Thermocouple probe, type K
A 1146 Sound probe, class 1
A 1151 Sound probe, class 2
A 1131 Black globe thermometer
A 1180 CO ₂ probe
A 1181 CO probe
PC SOFTWARE
A 1134 SensorLink PRO
A 1167 SoundLink LITE
A 1162 SoundLink PRO
CERTIFICATES
ISO calibration certificate for complete system
Calibration certificate

Selection Guide for Indoor Environment Quality Analysers

	MI 6201PR	MI 6201EU Multinorm	MI 6201ST	MI 6301PR FonS	MI 6301EU	MI 6401EU Poly	MI 6401ST
✓	✓	✓	–	–	✓	✓	
✓	✓	✓	–	–	✓	✓	
✓	✓	✓	–	–	✓	✓	
✓	✓	✓	–	–	✓	✓	
Option	Option	Option	–	–	Option	Option	
Option	Option	Option	–	–	Option	Option	
✓	✓	✓	–	–	✓	✓	
Option	Option	Option	–	–	Option	Option	
Option	Option	Option	–	–	Option	Option	
Option	Option	Option	–	–	Option	Option	
Option	Option	Option	–	–	Option	Option	
✓	–	–	✓	–	–	–	
–	✓	✓	–	✓	–	–	
✓	✓	✓	✓	✓	–	–	
✓	✓	✓	✓	✓	–	–	
✓	✓	✓	–	–	✓	✓	
Option	Option	Option	–	–	Option	Option	
Option	Option	Option	–	–	Option	Option	
Option	Option	Option	–	–	Option	Option	
✓	✓	✓	–	–	✓	✓	
✓	✓	✓	✓	✓	–	–	
Option	Option	Option	Option	Option	–	–	
✓	✓	–	✓	✓	✓	–	
–	–	✓	–	–	–	✓	

MI 6201 Multinorm

The MI 6201 Multinorm is a portable multifunctional handheld instrument for measuring microclimate, sound and light parameters and it is an invaluable tool for the monitoring and evaluation of indoor environmental conditions according to national and European standards. Specially designed housing enables connection of a few probes at the same time for testing of several parameters simultaneously. A large selection of measuring probes allows to measure variety of different environmental conditions. The SensorLink PRO and SoundLink LITE software come as standard accessories and enable downloading data stored in the memory, plotting and printing test results in table and graphic form, on-screen graph plotting for straightforward data comparison and export of data in text file format. The MI 6201EU set comes complete with full ISO accredited calibration certificate while the MI 6201PS set comes complete with ISO calibration certificate and an upgraded sound probe (class 1).

MEASUREMENTS:

- Air temperature;
- Air velocity;
- Air flow;
- Relative humidity;
- Dew point;
- Temperature difference (option);
- K thermocouple temperature (option);
- Illuminance;
- Luminance (option);
- Contrast (option);
- Black globe radiant temperature (option);
- CO and CO2 concentration (option);
- Sound level;
- Real time 1/1 and 1/3 octave analysis.

KEY FEATURES:

- **Adaptable:** MI 6201 Multinorm can be used as either a sound meter or environmental meter to reduce the amount of measuring equipment to move between locations.
- **Environmental:** using various standard and optional probes, the MI 6201 can be adapted to measure and calculate a combination of up to 16 different environment parameters (maximum 11 at the same time).
- **Sound:** the instrument can simultaneously measure and calculate 19 different sound parameters (displaying maximum 6 at the same time).
- **Long lasting:** record up to 160 days worth of data.
- **Accommodating:** due to optional prolongation cable or telescopic rod measurements in hard-to-reach spots are possible, while mounting on a tripod enables long-lasting recording.
- **Versatile:** can be used for spot checking of different locations or performing long investigations in a specific location.
- **Easy to use:** plug in the suitable probes and the device will automatically adjust for appropriate measurements.
- **PPD and PMV calculations:** predicted



Percentage of Dissatisfied People (PPD) and Predicted Mean Vote (PMV) calculations are performed automatically.

- **Weighting:** A, C, Z frequency weightings and fast, slow and impulse time weightings.
- **Octave frequency analysis:** instrument performs real time octave and one third octave frequency analysis in accordance with EN 61260 standard.
- **Logger:** logging memory module allows to save up to 4000 measurements with adjustable integration period.
- **Downloadable:** up to 4000 test results can be stored in a two level memory structure and then downloaded to the PC with the help of the PC software.

APPLICATION:

- Indoor air quality testing;
- Testing of factory climatic conditions;

- Testing of heating, ventilation and air conditioning systems;
- Testing of lighting conditions;
- Emergency lighting systems testing;
- Indoor or dry outdoor sound level measurement;
- Industrial sound measurement;
- Band-pass and acoustic filter testing;
- Acoustic equipment testing.

STANDARDS:

Functionality:

DIN 5032 P1; DIN 5032 P2; DIN 5032 P3; DIN 5032 P4; DIN 5032 P6; DIN 5032 P7; EN 60751; EN 60584-1; EN 12599; EN ISO 7726; ISO 10526; ISO 10527

Electromagnetic compatibility:

EN 61326

Safety:

EN 61010-1

TECHNICAL SPECIFICATION:

Function	Measuring range	Resolution	Accuracy
Microclimatic probe A 1091			
- Air temperature	-20 °C ... +60 °C	0.1 °C	±0.2 °C at 25°C ±0.5 °C over working range
- Relative humidity	0 %RH ... 10 %RH	0.1 %RH	±3 %RH
	10 %RH ... 90 %RH	0.1 %RH	±2 %RH
	90 %RH ... 100 %RH	0.1 %RH	±3 %RH
- Air velocity	0.10 m/s ... 9.99 m/s	0.01 m/s	±(0.05 m/s + 5 % of reading)
	10.0 m/s ... 20.0 m/s	0.1 m/s	±(5 % of reading)
Temperature and humidity probe A 1127			
- Air temperature	-20 °C ... +60 °C	0.1 °C	±0.5 °C
- Relative humidity	0 %RH ... 100 %RH	0.1 %RH	±3 %RH
Black Globe temperature (A 1131)	10.0 °C ... 49.9 °C	0.1 °C	±0.5 °C
	50.0 °C ... 84.9 °C	0.1 °C	±1.0 °C
	85.0 °C ... 120.0 °C	0.1 °C	±1.5 °C
Illuminance (A 1092; DIN 5032, Class B)	0.01 Lux ... 19.99 Lux	0.01 Lux	±(0.02 Lux +8 % of reading)
	20.0 Lux ... 199.9 Lux	0.1 Lux	±(8 % of reading)
	200 Lux ... 1999 Lux	1 Lux	±(8 % of reading)
	2000 Lux ... 20000 Lux	10 Lux	±(8 % of reading)
Luminance (A 1132; DIN 5032, Class B)	0.1 cd/m ² ... 39.9 cd/m ²	0.1 cd/m ²	±(0.2 cd/m ² + 8% of reading)
	40 cd/m ² ... 399 cd/m ²	1 cd/m ²	±(8 % of reading)
	400 cd/m ² ... 3999 cd/m ²	1 cd/m ²	±(8 % of reading)
	4000 cd/m ² ... 40000 cd/m ²	1 cd/m ²	±(8 % of reading)
CO ₂ concentration (A 1180)	0 ppm ... 5000 ppm	1 ppm	±(3 % of reading + 40 ppm)
CO concentration (A 1181)	0 ppm ... 500 ppm	1 ppm	±(5 % of reading + 5 ppm)
Sound level (A 1146)	30 dB ... 140 dB	0.1 dB	Corresponds to EN 61672 Class 1
Sound level (A 1151)	30 dB ... 140 dB	0.1 dB	Corresponds to EN 61672 Class 2
Sound probes A 1146 and A 1151	- Dynamic range: 80 dB - Frequency weighting: A, C, Zero - Time weighting: fast, slow, impulse		
COM port	USB		
Memory	up to 4000 values		
Display	Graphical LCD with backlight, 160 x 160 dots		
Power supply	6 x 1.2 V rechargeable batteries, type AA		
Protection degree	IP 40		
Dimensions	110 x 85 x 220 mm		
Weight	0.56 kg		

STANDARD SET:

MI 6201ST

- Instrument Multinorm
- Carrying case
- Probe adapter
- Microclimatic probe
- Illumination probe, type B
- Sound probe, class 2, with foam wind-screen
- Plastic shield for microphone
- Tripod adapter
- USB cable
- Power supply adapter
- 6 x NiMH rechargeable batteries, type AA
- PC SW SensorLink PRO

- PC SW SoundLink LITE
- Instruction manual
- Calibration certificate

MI 6201EU

- MI 6201ST
- ISO calibration certificate for complete system

MI 6201PS

- MI 6201EU
- Sound probe, class 1 (A 1146) instead of Sound probe, class 2 (A 1151)



MI 6301 FonS

The MI 6301 FonS is a professional sound analyser for sound measurements in accordance with EN 61672 standard Class 1 or Class 2. The MI 6301 contains usual A, C and Z frequency weightings and fast, slow and impulse time weightings and in addition the instrument has 2 independent measuring channels which can be set to different weightings. The MI 6301 FonS is ideal for spot checking different locations or performing long term analysis of an area. The PC software SoundLink LITE included in the standard set enables downloading, review, export and printing of test results while the optional PC SW SoundLink PRO enables full data analysis, charting and report generation.

MEASUREMENTS:

- LXY (Time weighted sound level);
- LXeq (Time average sound level);
- LXYmax (Maximum time weighted sound level);
- LXYmin (Minimum time weighted sound level);
- LXpeak (Peak sound level);
- LXE (Sound exposure level);
- Percentile sound pressure level;
- Real time 1/1 octave analysis;
- Real time 1/3 octave analysis.

KEY FEATURES:

- **Adaptable:** the instrument can simultaneously measure and calculate 19 different sound parameters (displaying maximum 6 at the same time).
- **Weighting:** A, C, Z frequency weightings and fast, slow and impulse time weightings in accordance with EN 61672 standard.
- **Dual measuring:** two independent sound measuring channels that can be set to different time and weighting settings.
- **Octave frequency analysis:** instrument performs real time octave and one third octave frequency analysis in accordance with EN 61260 standard.
- **Long lasting:** record up to 80 days worth of data.
- **Versatile:** can be used for spot checking of different locations or performing long investigations in a specific location.
- **One stop readings:** according to custom configuration instrument can display MAX, MIN, peak readings, equalised readings, channel 1 and channel 2 readings.
- **Logger:** logging memory module allows to save up to 2000 measurements with adjustable integration period.
- **Downloadable:** up to 2000 test results can be stored in the two level memory structure and then downloaded to the PC with the help of the PC software.



APPLICATION:

- Indoor or dry outdoor sound level measurement;
- Industrial sound measurement;
- Acoustic equipment testing;
- Band-pass and acoustic filter testing.

STANDARDS:

Functionality: EN 61672; EN 61260
Electromagnetic compatibility: EN 61326
Safety: EN 61010-1

KEY FEATURES



Sample of on-line reading data analysis with SoundLink PRO PC software.



Logged data analysis with SoundLink PRO PC software.

TECHNICAL SPECIFICATION:

Function	Measuring range	Resolution	Accuracy
Sound level (A 1146)	30 dB ... 140 dB	0.1 dB	Corresponds to EN 61672 Class 1
Sound level (A 1151)	30 dB ... 140 dB	0.1 dB	Corresponds to EN 61672 Class 2
Sound probes A 1146 and A 1151	- Dynamic range: 80 dB - Frequency weighting: A, C, Zero - Time weighting: fast, slow, impulse		
COM port	USB		
Memory	2000 values		
Display	Graphical LCD with backlight, 160 x 160 dots		
Power supply	6 x 1.2 V rechargeable batteries, type AA		
Protection degree	IP 40		
Dimensions	110 x 85 x 220 mm		
Weight	0.56 kg		

STANDARD SET:

MI 6301EU

- Instrument FonS
- Carrying case
- Sound probe, class 2, with foam wind-screen
- Plastic shield for microphone
- Tripod adapter
- USB cable
- Power supply adapter
- 6 x NiMH rechargeable batteries, type AA

MI 6301PS

- PC SW SoundLink LITE
- Instruction manual
- Calibration certificate
- ISO calibration certificate for complete system
- MI 6301EU
- Sound probe, class 1 (A 1146) instead of Sound probe, class 2 (A 1151)



KEY FEATURES

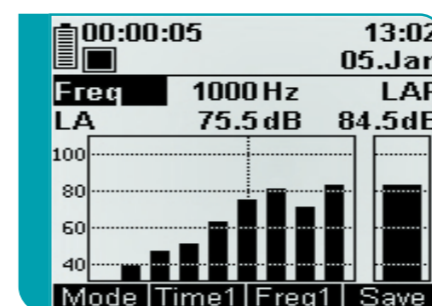
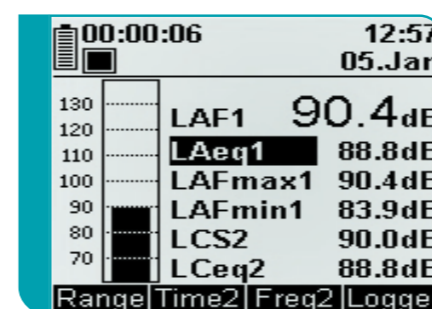

Sound measurement, 1/1 and 1/3 octavian analysis.

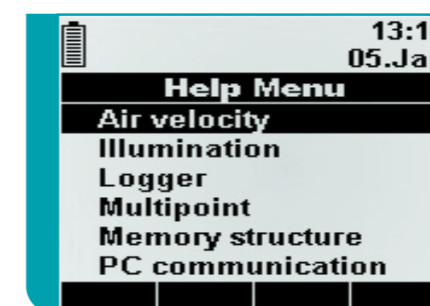
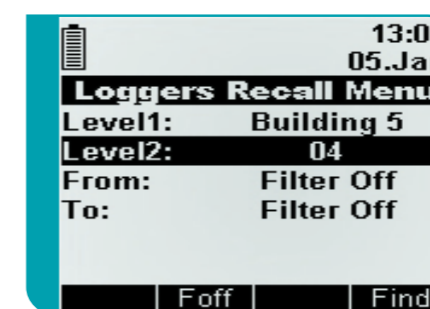

Recalling of memory, sample of help menu.



MI 6401 Poly

The MI 6401 Poly is a portable multifunctional handheld instrument for measuring microclimate and light parameters such as illuminance, humidity, air temperature and air velocity of an environment. Emergency lighting, ventilation systems, lighting conditions, air conditioning systems, factory conditions, production line conditions and many more can be tested by the MI 6401. Specially designed housing enables connection of a few probes at the same time for testing of several parameters simultaneously. All the results can be stored in the internal memory of the instrument and then downloaded to PC via the SensorLink PRO software which is included in the standard set. For full data traceability to international standards the MI 6401EU set includes a full ISO accredited calibration certificate.

MEASUREMENTS:

- Air temperature;
- Air velocity;
- Air flow;
- Relative humidity;
- Dew point;
- Temperature difference (option);
- K thermocouple temperature (option);
- Illuminance;
- Luminance (option);
- Contrast (option);
- Black globe radiant temperature (option);
- CO and CO₂ concentration (option).

KEY FEATURES:

- **Adaptable:** using various standard and optional probes, the MI 6401 can be adapted to measure and calculate a combination of up to 16 different environments conditions (maximum 11 at the same time).
- **Long lasting:** record up to 160 days worth of data.
- **Accommodating:** due to optional prolongation cable or telescopic rod measurements in hard-to-reach spots are possible, while mounting on a tripod enables long-lasting recording.
- **Versatile:** can be used for spot checking of different locations or performing long investigations in a specific location.
- **Easy to use:** plug in the suitable probes and the device will automatically adjust for appropriate measurements.
- **PPD and PMV calculations:** predicted Percentage of Dissatisfied People (PPD) and Predicted Mean Vote (PMV) calculations are performed automatically.
- **Logger:** logging memory module allows to save up to 4000 measurements with adjustable integration period.



- **Downloadable:** up to 4000 test results can be stored in a two level memory structure and then downloaded to the PC with the help of the PC software SensorLink PRO.

APPLICATION:

- Indoor air quality testing;
- Testing of factory climatic conditions;
- Testing of heating, ventilation and air conditioning systems;
- Testing of lighting conditions;
- Emergency lighting systems testing.

STANDARDS:

Functionality:

DIN 5032 P1; DIN 5032 P2; DIN 5032 P3; DIN 5032 P4; DIN 5032 P6; DIN 5032 P7; EN 60751; EN 60584-1; EN 12599; EN ISO 7726; ISO 10526; ISO 10527

Electromagnetic compatibility:

EN 61326

Safety:

EN 61010-1

TECHNICAL SPECIFICATION:

Function	Measuring range	Resolution	Accuracy
Microclimatic probe A 1091			
- Air temperature	-20 °C ... +60 °C	0.1 °C	±0.2 °C at 25°C ±0.5 °C over working range
- Relative humidity	0 %RH ... 10 %RH 10 %RH ... 90 %RH 90 %RH ... 100 %RH	0.1 %RH 0.1 %RH 0.1 %RH	±3 %RH ±2 %RH ±3 %RH
- Air velocity	0.10 m/s ... 9.99 m/s 10.0 m/s ... 20.0 m/s	0.01m/s 0.1m/s	±(0.05 m/s + 5% of reading) ±(5% of reading)
Temperature and humidity probe A 1127			
- Air temperature	-20 °C ... +60 °C	0.1 °C	±0.5 °C
- Relative humidity	0 %RH ... 100 %RH	0.1 %RH	±3 %RH
Black Globe temperature (A 1131)	10.0 °C ... 49.9 °C 50.0 °C ... 84.9 °C 85.0 °C ... 120.0 °C	0.1 °C 0.1 °C 0.1 °C	±0.5 °C ±1.0 °C ±1.5 °C
Illuminance (A 1092; DIN 5032, Class B)	0.01 Lux ... 19.99 Lux 20.0 Lux ... 199.9 Lux 200 Lux ... 1999 Lux 2000 Lux ... 20000 Lux	0.01 Lux 0.1 Lux 1 Lux 10 Lux	±(0.02 Lux +8 % of reading) ±(8 % of reading) ±(8 % of reading) ±(8 % of reading)
Luminance (A 1132; DIN 5032, Class B)	0.1 cd/m ² ... 39.9 cd/m ² 40 cd/m ² ... 399 cd/m ² 400 cd/m ² ... 3999 cd/m ² 4000 cd/m ² ... 40000 cd/m ²	0.1 cd/m ² 1 cd/m ² 1 cd/m ² 1 cd/m ²	±(0.2 cd/m ² + 8 % of reading) ±(8 % of reading) ±(8 % of reading) ±(8 % of reading)
CO ₂ concentration (A 1180)	0 ppm ... 5000 ppm	1 ppm	±(3 % of reading + 40 ppm)
CO concentration (A 1181)	0 ppm ... 500 ppm	1 ppm	±(5 % of reading + 5 ppm)
COM port	USB		
Memory	4000 values		
Display	Graphical LCD with backlight, 160 x 160 dots		
Power supply	6 x 1.2 V rechargeable batteries, type AA		
Protection degree	IP 40		
Dimensions	110 x 85 x 220 mm		
Weight	0.56 kg		

STANDARD SET:

MI 6401ST

- Instrument Poly
- Carrying case
- Probe adapter
- Microclimatic probe
- Illumination probe, type B
- Tripod adapter
- USB cable
- Power supply adapter
- 6 x NiMH rechargeable batteries, type AA

- PC SW SensorLink PRO
- Instruction manual
- Calibration certificate

MI 6401EU

- MI 6401ST
- ISO calibration certificate for complete system



SensorLink

The SensorLink software works in conjunction with Metrel downloadable Indoor Environment Quality testers. The software automatically recognizes connected instrument and allows the customer to download test results saved on the instrument, review the results and print test reports. The Sensor Link is compatible with Metrel instruments MI 6201 Multinorm and MI 6401 Poly.

KEY FEATURES:

- **Automatic recognition of the instrument:** connected instrument to the PC is automatically recognized by the software.
- **Logger, Memory, Download:** Stored and downloaded data from the instrument could be organized, selected to group, viewed and compared for analyzing in graphs and tabelaric forms and printed in a report form.
- **Export of test results:** test results in text format can be exported to other programs (MS Excel, MS Word).
- **Test Reports:** automatic generation of test reports from the selected views and data with attached graphs.

PC SW SensorLink is compatible with:

- MI 6201 Multinorm
- MI 6401 Poly

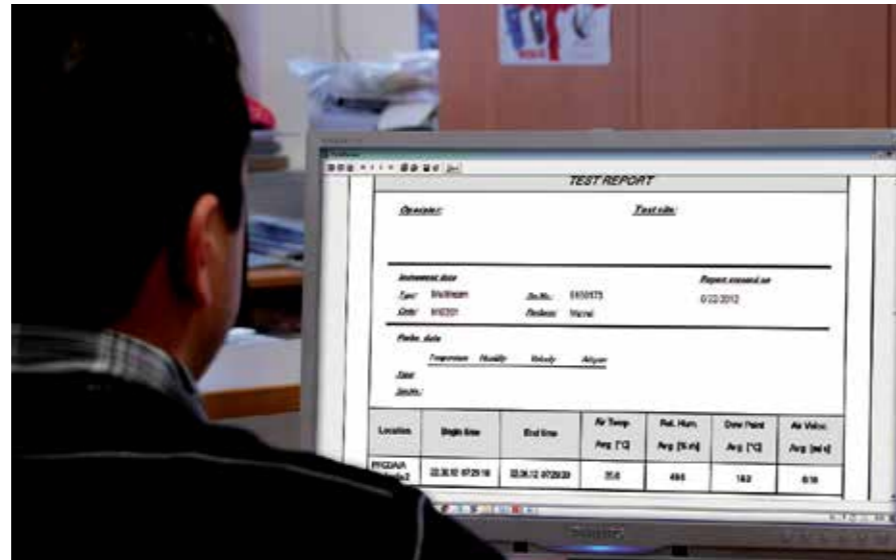

No	Time	Air Temp. Cur [°C]	Air Temp. Min [°C]	Air Temp. Avg [°C]	Air Temp. Max [°C]	Rel. Hum. Cur [%rh]	Rel. Hum. Min [%rh]	Rel. Hum. Avg [%rh]	Rel. Hum. Max [%rh]	Dew Point Cur [°C]	Dew Point Min [°C]	Dew Point Avg [°C]	Dew Point Max [°C]
1	21.06.12 11:38:14	26.7	26.7	26.7	26.7	45.1	45.1	45.1	45.1	14.2	14.2	14.2	14.2
2	21.06.12 11:38:18	26.7	26.7	26.7	26.7	45.2	45.1	45.2	45.2	14.2	14.2	14.2	14.2
3	21.06.12 11:38:24	26.7	26.7	26.7	26.7	45.0	45.0	45.0	45.0	14.0	14.0	14.0	14.0
4	21.06.12 11:38:28	26.7	26.7	26.7	26.7	45.5	45.5	45.5	45.5	14.0	14.0	14.0	14.0
5	21.06.12 11:38:34	26.7	26.7	26.7	26.7	45.1	45.1	45.5	45.5	13.9	13.9	13.9	13.9
6	21.06.12 11:38:38	26.7	26.7	26.7	26.7	44.9	44.8	45.0	45.1	13.8	13.8	13.8	13.8
7	21.06.12 11:38:44	26.7	26.7	26.7	26.7	44.7	44.7	44.8	44.8	13.7	13.7	13.7	13.7
8	21.06.12 11:38:48	26.7	26.7	26.7	26.7	44.5	44.5	44.6	44.7	13.6	13.6	13.6	13.7
9	21.06.12 11:38:54	26.7	26.7	26.7	26.7	44.5	44.5	44.5	44.5	13.6	13.6	13.6	13.6
10	21.06.12 11:38:58	26.7	26.7	26.7	26.7	44.4	44.4	44.5	44.5	13.6	13.6	13.6	13.6
11	21.06.12 11:39:04	26.6	26.6	26.6	26.7	44.5	44.4	44.5	44.5	13.6	13.6	13.6	13.6
12	21.06.12 11:39:08	26.5	26.6	26.5	26.6	44.5	44.4	44.5	44.5	13.6	13.5	13.5	13.5
13	21.06.12 11:39:14	26.6	26.6	26.6	26.6	44.5	44.5	44.5	44.5	13.6	13.6	13.6	13.6
14	21.06.12 11:39:18	26.5	26.6	26.5	26.6	44.6	44.5	44.5	44.5	13.6	13.6	13.6	13.6
15	21.06.12 11:39:24	26.6	26.6	26.6	26.6	44.5	44.6	44.7	44.8	13.7	13.6	13.6	13.6
16	21.06.12 11:39:28	26.5	26.6	26.5	26.6	45.1	44.9	45.1	45.1	13.9	13.7	13.7	13.7
17	21.06.12 11:39:34	26.6	26.6	26.6	26.6	45.0	45.0	45.1	45.1	13.7	13.7	13.7	13.7
18	21.06.12 11:39:38	26.6	26.6	26.6	26.6	45.0	45.0	45.0	45.0	13.7	13.7	13.7	13.7

Table with downloaded results of all connected probes

Draw a graphs of logged parameters

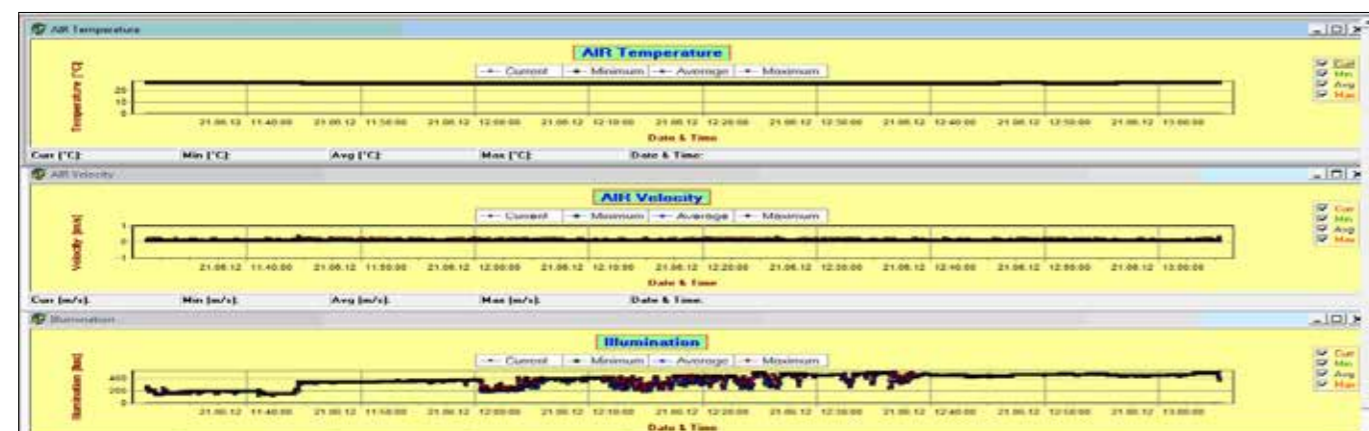

SoundLink

The Sound Link software works as a program for downloading, storing and retrieving measurement data from Metrel instruments MI 6201 Multinorm and MI 6301 FonS.

KEY FEATURES:

- **User friendly interface:** wide range of quick icons, for downloading, exporting, viewing and reorganizing data.
- **Structure organized data:** downloaded data are organized into tree structure where the locations could be renamed and / or equipped with comments.
- **Data filtering** and combining logger measurements as a function of time.
- **Zoom in Logger window:** Drag it and zoom rectangle will be drawn.
- **Spectrum window:** graph area and values area will show Octave and 1/3 Octave bars for analysis where selected logger or single 1/3 result shows four broadband values and 27 spectral components of the signal. Broadband values are shown as blue bars and every spectral component is shown as one bar with three different colours (each one for minimum, average and maximum).
- **Results window:** shows in tabular form values of measurements added from Tree window. Location name, start and end time and selected measurements are displayed in each line of table.

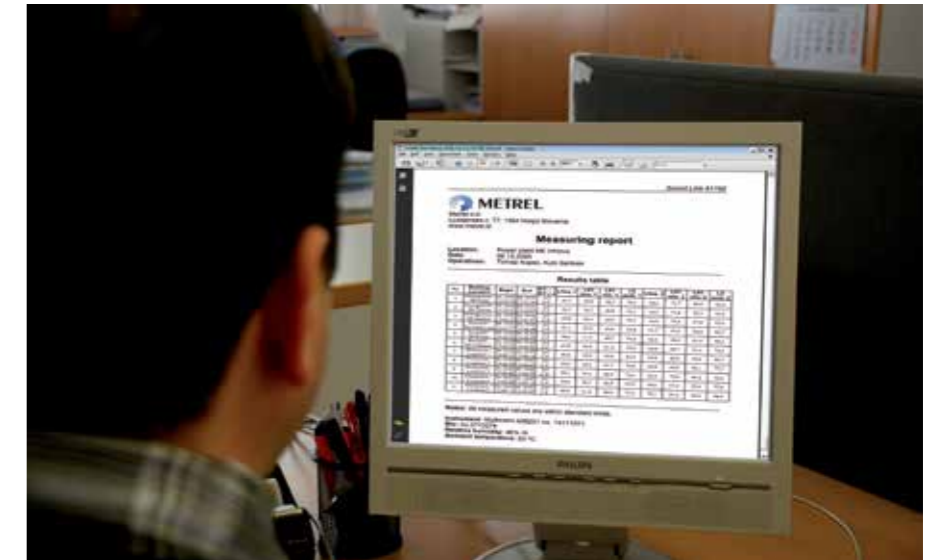

- **Add/remove measurements dialog:** In the same dialog you can select or deselect measurements that will be displayed in the table of Results window.
- **Export of test results:** test results can be exported to other programs (MS Excel, MS Word).

- **Test Reports:** automatic generation of test reports from the selected views and data with attached graphs.

PC SW SoundLink is compatible with:

- MI 6201 Multinorm
- MI 6301 FonS

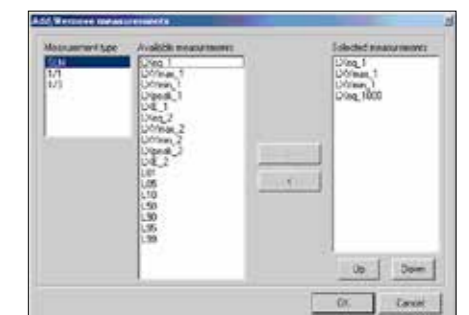

Measurements dialog offering wide range of available recorded measurements from instrument to be added or removed from analysis.

SoundLink PC SW Tool for Analysing and Reporting

Selection Guide for IEQ Accessories

Photo	Part number	Description	Target application	MI 6401	MI 6301	MI 6201
	A 1165	Sound calibrator, class 2	Sound calibrator Class 2 is intended for periodical calibration and accuracy inspection of the instrument.	-	✓	✓
	A 1152	Sound calibrator, class 1	Sound calibrator Class 1 is intended for periodical calibration and accuracy inspection of the instrument.	-	✓	✓
	A 1180	CO ₂ probe	Probe measures concentration of carbon dioxide in the ambient air.	✓	-	✓
	A 1181	CO probe	Probe measures concentration of carbon monoxide in the ambient air.	✓	-	✓
	A 1127	Humidity and temperature probe	Probe for simultaneous relative humidity and air temperature measurements.	✓	-	✓
	A 1131	Black globe thermometer	Black globe thermometer serves for indoor temperature comfort measurements.	✓	-	✓
	A 1132	Luminance probe	Luminance probe performs measurement of luminance i.e. light reflected from the surface.	✓	-	✓
	A 1128	Thermocouple probe, type K	Type K thermocouple probe with measuring range from -20 °C to 1400 °C for contact temperature measurements of various surfaces like motors, transformers, etc.	✓	-	✓
	A 1083	Power supply adapter with 6 pcs NiMH batteries, type AA	Battery charger and a set of 6 pieces of rechargeable batteries, type AA.	✓	✓	✓
	A 1160	Fast charger for 8 AA batteries with a set of 6 NiMH bat., type AA	Fast battery charger for up to 8 pieces of AA rechargeable batteries, and a set of 6 pcs NiMH rechargeable batteries, type AA.	✓	✓	✓
	A 1169	Fast charger for AA, C, D and 9 V block batteries	Fast battery charger for up to 12 pcs AA, 6 pcs C or D rechargeable batteries, 4 pcs 9 V block batteries.	✓	✓	✓
	A 1130	Telescopic rod with 2.5 m cable	The extension rod helps at measurements on remote spots like ventilation ducts and other places that cannot be easily reached by hand.	✓	-	✓

✓ Option - Not available

Selection Guide for IEQ Accessories

Photo	Part number	Description	Target application	MI 6401	MI 6301	MI 6201
	A 1145	Extension cable for A 1092 and A 1132, 1 m	1 m long extension cable can be used in combination with luminance and illuminance probe for measurements on remote spots.	✓	-	✓
	A 1159	Tripod	Tripod is used for instrument fixing at long term measurements of sound and other indoor air quality parameters.	✓	✓	✓
	A 1161	Tripod holder for black globe thermometer	Tripod holder assures fixing of the test instrument and Black globe thermometer on tripod.	✓	-	✓
	A 1162	PC SW SoundLink PRO	SoundLink PRO is a complete PC software for downloading, test data evaluation, profound sound analysis and test report creation.	-	✓	✓

✓ Option - Not available

Study the world
Capture the elements
Environmental testing made easy



MI 6201
Multinorm

MI 6401
Poly

MI 6301
FonS

MEASURING INSTRUMENTS AND TESTERS

- Electrical Installation Safety
- High Voltage Insulation / Continuity / Earth
- Appliance / Machine / Switchboard Safety
- Power Quality Analysis
- LAN Cabling Certification
- Indoor Environment Quality
- Digital Multimeters / Clamp Meters / Voltage and Continuity Testers
- Variable transformers /
- Equipment for laboratories and Schools

GOOD TO KNOW			
Digital Multimeters / Clamp Meters / Voltage and Continuity Tester	7	-	02
DIGITAL MULTIMETERS			
Selection Guide for Digital Multimeters	7	-	03
MD 9060 TRMS, 500.000 counts LCD, 100kHz Voltage Bandwidth Heavy Duty Industrial Multimeter	7	-	06
MD 9050 TRMS Heavy Duty Industrial Digital Multimeter	7	-	08
MD 9040 TRMS Industrial Digital Multimeter	7	-	09
MD 9035 Automotive Multimeter Designed to Work On Real-World Car Signals	7	-	10
MD 9030 TRMS General Purpose Digital Multimeter	7	-	11
MD 9020 General Purpose Digital Multimeter	7	-	12
MD 9016 Electrical Field Service Multimeter	7	-	13
MD 9015 Electrical Field Service Digital Multimeter	7	-	14
MD 9010 General Purpose Autocheck Digital Multimeter	7	-	15
CLAMP METERS			
Selection Guide for Clamp Meters	7	-	16
MD 9270 Leakage Clamp TRMS Meter with Power Functions	7	-	18
MD 9250 Industrial TRMS AC/DC CAT IV /1000 V	7	-	19
MD 9240 TRMS Power Clamp Meter	7	-	20
MD 9235 TRMS Power Clamp Meter, 3-Phase, Unbalanced-Load	7	-	21
MD 9230 Industrial TRMS AC/DC Current Clamp Meter	7	-	22
MD 9225 Most Complete Industrial TRMS AC/DC Current Clamp Meter	7	-	23
MD 9220 TRMS Current Clamp Meter	7	-	24
MD 9210 Mini Clamp Meter	7	-	25
VOLTAGE AND CONTINUITY TESTER			
Selection Guide for Voltage and Continuity Testers	7	-	26
MD 1155 LED Voltage / Continuity Tester NEW	7	-	27
MD 1055 LCD Voltage / Continuity Tester NEW	7	-	28
NON CONTACT VOLTAGE DETECTORS			
MD 115 Non Contact Voltage Detector	7	-	29
MD 105 Non Contact Voltage Detector	7	-	29
Selection Guide for DMM Accessories	7	-	30

Multimeter/Clamp/Voltage and Continuity Testers

Find out more about DMMs and Clamp Meters.

Handheld digital multimeters (DMM) are among the most widely used instruments for equipment testing when it comes to servicing, repairing, and installing applications.

A DMM is a digital meter that is capable of making various types of measurement. It may have any number of special features, but mainly a DMM measures volts, ohms, and amperes. DMMs are used to troubleshoot electrical problems in a wide array of industrial and household devices such as batteries, motor controls, appliances, power supplies, and wiring systems.

Metrel DMMs are appropriate for testing under tough conditions and can be tossed into tool cases.

When choosing a clamp meter not only look at specifications, but also pay attention to features, functions, and the overall value represented by a meter's design:

- Choose a clamp meter that gives accurate and repeatable results.
- For precise measurements choose a clamp meter which reports TRMS reading. Otherwise noise from everything from a variable frequency drive to compact fluorescent bulbs can result in a less accurate reading.
- Make sure that the clamp meter is specified to work in the environment you do and that are rugged enough to continue to give reliable results even in case they drop from ladders or bouncing in your tool case.
- Be sure the clamp meter display has large, easy to read characters.

RMS (Root Mean Square) value

When an AC supply is placed onto a circuit, it produces heat. The RMS value is the equivalent DC supply that would produce the same amount of thermal heat as the actual AC supply.

TRMS (True RMS) value

TRMS is a specific method of measuring the RMS value of a signal. With inductive and capacitive systems distorting the sinusoidal wave of the mains supply, this method provides the most accurate RMS value regardless of the shape of the waveform.

Resolution

Resolution is the smallest possible change in a signal that would produce a change in the value on the screen of the test instrument. For example, if the DMM has a resolution of 1 mV on the 4 V range, it is possible to see a change of 1 mV (1/1000 of a volt) while reading 1 V.

Accuracy

Accuracy is a value to show how accurately an instrument can read a specific value. This is usually written as a percentage (e.g. $5\text{ V} \pm 5\%$). An accuracy of one percent of reading means that for a displayed reading of 100 volts, the actual value of the voltage could be anywhere between 99 volts and 101 volts.

Number of Counts

The number of divisions into which a given measuring range is divided. This can be used to evaluate the resolution of an instrument.

The basics of measurements

DC and AC voltage

One of the most basic tasks of a DMM is measuring voltage. A typical DC voltage source are the batteries while AC voltage is usually created by a generator. The wall outlets are common sources of AC voltage.

Testing for proper supply voltage is usually the first step when troubleshooting a circuit. If there is no voltage present, or if it is too high or too low, the voltage problem should be corrected before investigating further.

A DMM's ability to measure AC voltage can be limited by the frequency of the signal. Most DMMs can accurately measure AC voltages with frequencies from 50 Hz to 500 Hz, but a DMM's AC measurement bandwidth may be hundreds of kilohertz wide. Such a meter may read a higher value because it is capable to see more of a complex ac signal. DMM accuracy specifications for AC voltage and AC current should state the frequency range along with the range's accuracy.

Frequency is measured in hertz (Hz) the number of times per second a waveform repeats. Maintaining the right frequency is crucial for devices that rely on AC voltage and current.

Crest factor

The crest factor describes the ratio of the peak value to the RMS value of an electrical variable (AC voltage and AC current). High crest factors cause distortion of the reactive power and harmonics in the supply network, and so are undesirable.

Resistance

Resistance values can vary greatly, from a few milliohms ($m\Omega$) for contact resistance to billions of ohms for insulators. Most DMMs measure from $0.1\ \Omega$, up to $300\ M\Omega$. At Metrel DMM display is infinite resistance (open circuit) read as "OL" and means that the resistance is greater than the meter can measure. Resistance measurements must be made with the circuit power off – otherwise, the meter or circuit could be damaged.

Continuity

Continuity is a quick "go/no-go" resistance test that distinguishes between an open and a closed circuit. A DMM with a continuity beeper allows you to complete many continuity tests easily and quickly. The DMM will beep if there is good continuity, or a good path that allows current to flow. If there is no continuity, the DMM won't beep.

Multimeter/Clamp/Voltage and Continuity Testers

Diode test

This mode measures and displays the actual voltage drop across a junction. A silicon junction should have a voltage drop less than 0.7 V when applied in the forward direction and an open circuit when applied in the reverse direction. When the red (+) lead is connected to the anode and the black (-) to the cathode, the diode should conduct and the meter will display a value (usually the voltage across the diode in mV, $1000\text{mV} = 1\text{V}$). After reversing the connections the diode should not conduct this way so the meter will display "OL".

Capacitance

To test capacitance, set the dial on the DMM to the capacitance function and plug in your leads. After ensuring that the capacitor has been discharged, connect the test leads to the capacitor terminals and take a reading. If the measurement is similar to the rating listed on the capacitor, the capacitor is good. A significant variation from the rating indicates the capacitor should be replaced.

DC and AC current

Current measurements are different from other DMM measurements. Current measurements taken with the DMM alone require placing the meter in series with the circuit being measured. This means opening the circuit and using the DMM test leads to complete the circuit. This way all the circuit current flows through the DMM's circuitry.

Current with Clamp Meter

Today's clamp meters are capable of measuring both AC and DC current. Typical current measurements are taken on various branch circuits of an electrical distribution system. By taking current measurements along the run of a branch circuit, it can be easily determined how much each load along the branch circuit is drawing from the distribution system.



Selection Guide for Multimeters

Part No.:	MD 9060	MD 9050	MD 9040
True RMS	✓	✓	✓
DC current range (A)	10	10	10
Basic accuracy (%)	0.15	0.2	0.2
Maximum resolution (µA)	0.1	0.1	0.1
AC current range (A)	10	10	10
Basic accuracy (%)	0.5	0.6	0.6
Maximum resolution (µA)	0.1	0.1	0.1
DC voltage range (V)	1000	1000	1000
Basic accuracy (%)	0.02	0.06	0.06
Maximum resolution (µV)	10	10	10
AC voltage range (V)	1000	1000	1000
Basic accuracy (%)	0.3	0.5	0.5
Maximum resolution (µV)	10	10	10
Resistance measurement (MΩ)	50	60	60
Basic accuracy (%)	0.07	0.1	0.1
Maximum resolution (mΩ)	100	100	100
Acoustic continuity test	✓	✓	✓
Diode test	✓	✓	✓
Capacitance	✓	✓	✓
Frequency measurement	✓	✓	✓
Frequency of digital signals	✓	✓	✓
Temperature measurement (Type K sensor)	T1 & T2 (temperature comparison)	T1 & T2 (temperature comparison)	-
Autocheck® V / Ω	-	✓	-
Conductance (nS)	✓	✓	-
IP-RPM (Inductive pickup type)	-	-	-
IG-RPM (Contact signal type)	-	-	-
Dwell – Angle function	-	-	-
% - Duty Function	-	-	-
Fuel injection – ms detector	-	-	-
100 kHz Voltage Bandwidth	✓	-	-
Variable frequency drive	✓	-	-
Count	50,000 (fast mode) 500,000 (DCV) 99,999 (Hz)	9999 (AC/DCV, Hz, nS) 6000 (mV, µmA, Ω, F)	-
Backlight	✓	✓	-
Analogue bar-graph	41 segment	41 segment	41 segment
IR, RS232 interface	✓	✓	✓
Automatic and manual range selection	✓	✓	✓
Automatic switch off	✓	✓	✓
Non-contact electrical field detection (EF)	-	✓	-
MAX hold	✓	-	-
Peak hold	✓	✓	-
Data hold	✓	✓	✓
Recording (MAX / MIN / AVG)	✓	✓	✓
Relative value	✓	✓	✓
Compensation for test leads	-	✓	✓
Overvoltage category	CAT IV / 1000 V	CAT IV / 1000 V	CAT IV / 1000 V
Dimensions with holster (mm)	208 x 103 x 64.5	208 x 103 x 64.5	208 x 103 x 64.5
Weight with holster (g)	635	635	635
CE mark	✓	✓	✓

MD 9035	MD 9030	MD 9020	MD 9016	MD 9015	MD 9010
-	✓	-	-	-	-
10	10	10	8	10	0.002
0.7	1.2	1.2	0.5	0.8	1.2
0.1	0.1	0.1	0.1	0.1	0.1
10	10	10	8	10	0.002
2.2	1.5	1.5	1.0	1	1.5
0.1	0.1	0.1	0.1	0.1	0.1
1000	1000	1000	1000	1000	600
0.4	0.3	0.3	0.4	0.3	0.5
10	100	100	10	100	1000
1000	1000	1000	1000	750	600
2.0	1.5	1.5	1.0	1	1.5
10	100	100	10	100	1000
60	40	40	60	25	6
0.5	0.6	0.6	0.5	0.4	1
100	100	100	100	100	100
✓	✓	✓	✓	✓	✓
✓	✓	✓	✓	✓	✓
✓	✓	✓	✓	✓	✓
✓	✓	✓	✓	✓	✓
-	-	-	✓	-	-
T1	T1	T1	T1	T1	-
-	-	-	-	-	✓
-	-	-	-	-	-
✓	-	-	-	-	-
✓	-	-	-	-	-
✓	-	-	-	-	-
✓	-	-	-	-	-
-	-	-	-	-	-
6000	4000	4000	6000	2500	6000
✓	✓	-	-	-	-
24 segment	-	-	24 segment	-	-
-	-	-	✓	✓	-
✓	✓	✓	✓	✓	Auto
✓	✓	✓	✓	✓	✓
-	-	-	✓	✓	✓
-	✓	✓	✓	-	-
-	-	-	-	-	-
✓	✓	✓	✓	✓	-
-	-	-	-	-	-
-	✓	✓	✓	✓	-
-	-	-	-	-	-
CAT II / 1000 V	CAT IV / 300 V CAT III / 600 V CAT II / 1000 V	CAT IV / 300 V CAT III / 600 V CAT II / 1000 V	CAT IV / 300 V CAT III / 600 V CAT II / 1000 V	CAT IV / 300 V CAT III / 600 V CAT II / 1000 V	CAT III / 300 V CAT II / 600 V
161 x 80 x 50	198 x 97 x 55	198 x 97 x 55	161 x 80 x 50	160 x 82 x 48	113 x 53 x 10.2
340	396	396	340	345	78
✓	✓	✓	✓	✓	✓

MD 9060 TRMS, 500.000 counts LCD, 100 kHz Voltage Bandwidth Heavy Duty Industrial Multimeter

The MD 9060 ranks among the most accurate multimeters with a large bandwidth and very high resolution. Metrel MD 9060 is equipped with a built-in VFD feature that makes the instrument capable of measuring the true values in accordance with frequency, large 2-line 500.000 counts LCD display, fast data acquisition and transfer (via optical interface), CAT IV / 1000 V, TRMS current and voltage measurement, conductance measurement and fast one-handed operation. MD 9060 has a wide range of extra features, including data hold, memory, min / max, average, differential, peak, peak / peak with extra fast 1ms response time, auto power off, frequency filter, reset and relative function.

The MD 9060 is the ideal choice for demanding measurement tasks in industry, in the laboratories and in everyday repair and maintenance practice.

MEASURING FUNCTIONS:

- TRMS AC, DC voltage measurement;
- TRMS AC, DC current measurement;
- Capacitance measurement;
- Resistance measurement;
- Diode test;
- Mains supply frequency measurement;
- Frequency of digital signals measurement;
- Continuity test (acoustic signaling);
- Conductance measurement;
- Temperature measurement.

KEY FEATURES:

- **TRMS:** accurate readings on sinusoidal and non-sinusoidal signals.
- **VFD:** feature makes the instrument capable of measuring the true values in accordance with frequency.
- **Auto-ranging:** user can switch between auto and manual ranging.
- **Temperature measurement:** measures T1, T2 and T1 + T2 temperature in Celsius and in Fahrenheit.
- **Lead alert:** incorrect lead connection alert.
- **Relative zero mode:** relative function for comparing the difference between signals or removing background noise.
- **MAX/MIN/AVG:** recording of maximum, minimum and average values.
- **Data Hold:** data hold feature freezes the display for later view.
- **Peak Hold:** Crest (instantaneous peak) capture mode.
- **PC Link:** test results can be downloaded to the computer via the optional PC software.
- **Safety:** CAT IV / 1000 V overvoltage protection.
- **Backlight:** large bright 4 digits 500.000 counts dual LCD display with backlight for working in dark conditions.

APPLICATION:

- High level industrial testing;
- High level electronic fault finding;



- Field servicing;
- Heavy duty electrical testing.

STANDARD SET:

- Multimeter MD 9060 with rubber holster
- Test lead with probe, 2 pcs
- Thermocouple probe, type K
- 9 V battery,
- Instruction manual
- Warranty



TECHNICAL SPECIFICATION:

Function	Range	Accuracy
TRMS AC and AC+DC voltage (20 Hz ... 40kHz)	500.00 mV ... 1000.0 V	from ±(0.45% of reading + 40 digits) to ±(4.0% of reading + 40 digits)
DC Voltage	500.00 mV ... 1000.0 V	from ±(0.02% of reading + 2 digits) to ±(0.15% of reading + 2 digits)
AC Voltage (20 Hz ... 100 kHz)	500.00 mV ... 1000.0 V	from ±(0.3% of reading + 20 digits) to ±(4.0% of reading + 40 digits)
DC Current	500.00 µA ... 10.000 A	from ±(0.15% of reading + 20 digits) to ±(0.5% of reading + 20 digits)
TRMS AC and AC+DC Current (40 Hz ... 100 kHz)	600.0 µA ... 10.00 A	from ±(0.5% of reading + 50 digits) to ±(5.0% of reading + 50 digits)
Diode Test	2.0000 V Open-circuit voltage < 3.5 V DC, Test current 0.4 mA	±(1.0% of reading + 1 digit)
Resistance	500.00 Ω ... 50.000 MΩ	from ±(0.07% of reading + 10 digits) to ±(2.0% of reading + 6 digits)
Conductance	99.99 nS	±(2.0% of reading + 10 digits)
Capacitance	50.00 nF ... 25.00 mF	from ±(0.8% of reading + 3 digits) to ±(6.5% of reading + 5 digits)
Temperature	-50.0 °C ... 1000.0 °C -58.0 °F ... 1832.0 °F	±(0.3% of reading + 1.5 °C) ±(0.3% of reading + 3.0 °F)
Variable Frequency Drive AC	5 Hz ... 440 Hz	from ±(2.0% of reading + 50 digits) to ±(6.0% of reading + 80 digits)
Frequency of digital equipment	5.000 Hz ... 1.0000 MHz	±(0.002% of reading + 4 digits)
Mains frequency	10 Hz ... 200 kHz	±(0.02% of reading + 4 digits)
Power supply	9V battery (NEDA1604G, JIS006P, or IEC6F22)	
Overvoltage category	CAT IV / 1000 V	
Dimensions	208 x 103 x 64.5 mm	
Weight	635 g	

MD 9050 TRMS Heavy Duty Industrial Digital Multimeter

The MD 9050 ranks among the best multimeters on the market. High resolution and accuracy, 2-line LCD display, fast data acquisition and transfer (via optical interface), CAT IV / 1000 V, TRMS current and voltage measurement, non-contact voltage detection, conductance measurement, auto check function and fast one-handed operation are highlights of the multimeter. The MD 9050 is the ideal choice for demanding measurement tasks in industry, in the laboratories and in everyday repair and maintenance practice.

MEASURING FUNCTIONS:

- TRMS AC, DC voltage measurement;
- TRMS AC, DC current measurement;
- Capacitance measurement;
- Resistance measurement;
- Diode test;
- Mains supply frequency measurement;
- Frequency of digital signals measurement;
- Continuity test (acoustic signalling);
- Conductance measurement;
- Electric field detection;
- Temperature measurement.

KEY FEATURES:

- **TRMS:** accurate readings on sinusoidal and non-sinusoidal signals.
- **Autocheck function:** automatic detection of AC voltage, DC voltage or resistance.
- **Auto-ranging:** user can switch between auto and manual ranging.
- **Temperature measurement:** measures T1, T2 and T1 + T2 temperature in Celsius and in Fahrenheit.
- **EF detection:** non-contact and probe-contact electric field detection.
- **Lead alert:** incorrect lead connection alert.
- **Relative zero mode:** relative function for comparing the difference between signals or removing background noise.
- **MAX/MIN/AVG:** recording of maximum, minimum and average values.
- **Data Hold:** data hold feature freezes the display for later view.
- **Peak Hold:** Crest (instantaneous peak) capture mode.
- **PC Link:** test results can be downloaded to the computer via the optional PC software.
- **Safety:** CAT IV / 1000 V overvoltage protection.
- **Backlight:** large bright 4 digits 9999 counts dual LCD display with backlight for working in dark conditions.

APPLICATION:

- High level industrial testing;
- High level electronic fault finding;
- Field servicing;
- Heavy duty electrical testing.

STANDARD SET:

- Multimeter MD 9050 with rubber holster
- Test lead with probe, 2 pcs
- Thermocouple probe, type K
- 9 V battery
- Instruction manual
- Warranty



TECHNICAL SPECIFICATION:

Function	Range	Accuracy
TRMS AC and AC+DC voltage (40 Hz ... 20 kHz)	60.00 mV ... 999.9 V	from ±(0.5 % of reading + 3 digits) to ±(3.0 % of reading + 4 digits)
Autocheck (ACV)	9.999 V ... 999.9 V	±(1.0 % of reading + 4 digits)
DC voltage	60.00 mV ... 999.9 V	from ±(0.06 % of reading + 2 digits) to ±(0.12 % of reading + 2 digits)
Autocheck (DCV)	9.999 V ... 999.9 V	±(0.5 % of reading + 3 digits)
DC current	600.0 µA ... 10.00 A	±(0.2 % of reading + 4 digits)
TRMS AC and AC+DC current (40 Hz ... 1 kHz)	600.0 µA ... 10.00 A	from ±(0.6 % of reading + 3 digits) to ±(1.0 % of reading + 4 digits)
Diode test	2.000 V	±(1.0 % of reading + 1 digit)
Resistance	600.0 Ω ... 60.00 MΩ	Open-circuit voltage < 3.5 V _{DC} , test current 0.4 mA from ±(0.1 % of reading + 3 digits) to ±(1.5 % of reading + 5 digits)
Conductance	99.99 nS	±(0.8 % of reading + 10 digits)
Autocheck (resistance)	600.0 Ω ... 60.00 MΩ	from ±(0.5 % of reading + 4 digits) to ±(2 % of reading + 5 digits)
Mains frequency	15.00 Hz ... 50.00 kHz	±(0.04 % of reading + 4 digits)
Frequency of digital equipment	5.00 Hz ... 1.000 MHz	±(0.004 % of reading + 4 digits)
Capacitance	60.00 nF ... 25.00 mF	from ±(0.8 % of reading + 3 digits) to ±(6.5 % of reading + 5 digits)
Temperature	-50 °C ... +1000 °C	±(0.3 % of reading + 2 °C)
Power supply	9 V battery (NEDA1604G, JIS006P, or IEC6F22)	
Overvoltage category	CAT IV / 1000 V	
Dimensions	208 x 103 x 64.5 mm	
Weight	635 g	

MD 9040 TRMS Industrial Digital Multimeter

CAT IV / 1000 V overvoltage category and TRMS measurement of AC current and voltage are key features of the MD 9040. That's why it is particularly suitable for performing measurements on power supply sources in the most demanding applications in the industrial sector. Its high accuracy, 2-line LCD display, diverse measurement functions, fast one-handed operation and outstanding value for money open up a wide range of possible uses.

MEASURING FUNCTIONS:

- TRMS AC, DC voltage measurement;
- TRMS AC, DC current measurement;
- Capacitance measurement;
- Resistance measurement;
- Diode test;
- Mains supply frequency measurement;
- Frequency of digital signals measurement;
- Continuity test (acoustic signalling).

KEY FEATURES:

- **TRMS:** accurate readings on sinusoidal and non-sinusoidal signals.
- **Lead alert:** incorrect lead connection alert.
- **Auto-ranging:** user can switch between auto and manual ranging.
- **Relative zero mode:** relative function for comparing the difference between signals or removing background noise.
- **MAX/MIN/AVG:** recording of maximum, minimum and average values.
- **Data Hold:** data hold feature freezes the display for later view.
- **PC Link:** test results can be downloaded to the computer via the optional PC software.
- **Frequency measurement:** up to 1 MHz.
- **Safety:** CAT IV / 1000 V overvoltage protection.
- **Easy to read:** large bright 4 digits 9999 counts dual LCD display.

APPLICATION:

- High level industrial testing;
- High level electronic fault finding;
- Field servicing;
- Heavy duty electrical testing.

STANDARD SET:

- Multimeter MD 9040 with rubber holster
- Test lead with probe, 2 pcs
- 9 V battery
- Instruction manual
- Warranty



TECHNICAL SPECIFICATION:

Function	Range	Accuracy
TRMS AC voltage (40 Hz ... 20 kHz)	60.00 mV ... 999.9 V	from ±(0.5 % of reading + 3 digits) to ±(3.0 % of reading + 4 digits)
DC voltage	60.00 mV ... 999.9 V	from ±(0.06 % of reading + 2 digits) to ±(0.12 % of reading + 2 digits)
DC current	600.0 µA ... 10.00 A	±(0.2 % of reading + 4 digits)
TRMS AC current (40 Hz ... 1 kHz)	600.0 µA ... 10.00 A	from ±(0.6 % of reading + 3 digits) to ±(1.0 % of reading + 4 digits)
Diode test	2.000 V	±(1.0 % of reading + 1 digit)
Resistance	600.0 Ω ... 60.00 MΩ	Open-circuit voltage < 3.5 V _{DC} , Test current 0.4 mA from ±(0.1 % of reading + 3 digits) to ±(1.5 % of reading + 5 digits)
Mains frequency	15.00 Hz ... 50.00 kHz	±(0.04 % of reading + 4 digits)
Frequency of digital equipment	5.00 Hz ... 1.000 MHz	±(0.004 % of reading + 4 digits)
Capacitance	60.00 nF ... 25.00 mF	from ±(0.8 % of reading + 3 digits) to ±(6.5 % of reading + 5 digits)
Power supply	9 V battery (NEDA1604G, JIS006P, or IEC6F22)	
Overvoltage category	CAT IV / 1000 V	
Dimensions	208 x 103 x 64.5 mm	
Weight	635 g	

MD 9035 Automotive Multimeter Designed to Work On Real-World Car Signals

Metrel MD 9035 is a unique automotive multimeter top class with many exciting features, such as: Selectable 4-stroke, 4-DIS/2-stroke, & 2-DIS engine RPM; Selectable Trig (+) / Trig- on % & ms readings; Selectable Sensitivity-Levels on RPM, Dwell, % & ms readings, BeepJack warning, Backlit display and Display hold. MD 9035 is also equipped with automatic range selection and extra fast analog bar-graph.

MEASURING FUNCTIONS:

- AC, DC voltage measurement;
- AC, DC current measurement;
- Capacitance measurement;
- Resistance measurement;
- Diode test;
- Both IP (inductive) & IG (contact) RPM;
- ms Fuel-injection on time;
- % Duty cycle;
- Dwell angle;
- Line-Level Hz (ACV, DCV);
- Frequency measurement;
- Continuity test (acoustic signaling);
- Electric field detection;
- Temperature measurement.

KEY FEATURES:

- **Line-Level:** measures frequency from 10 Hz to 50 kHz.
- **Auto-ranging:** user can switch between auto and manual ranging.
- **Hold:** data hold function freezes the display for later view.
- **Pickup clip:** Inductive pickup clip accessory for IP-RPM Function.
- **4 Selectable Trigger-Levels:** For IP-RPM, IG-RPM, Dwell, %-Duty and ms Functions.
- **Selectable Trigger:** Positive (+) or Negative (-) Trigger for %-Duty and ms Functions.
- **Selectable Cylinders:** 1, 2, 3, 4, 5, 6, 8, 10 or 12 Cylinders for Dwell and IG-RPM functions.
- **Safe:** CAT II / 1000 V, overvoltage protection.

APPLICATION:

- Automotive industry;
- High level industrial testing;
- High level electronic fault finding;
- Field servicing.

STANDARD SET:

- Multimeter MD 9035 with rubber holster
- Test lead with probe, 2 pcs
- Thermocouple probe, type K
- Inductive pickup clip
- 1.5 V battery, type AAA, 2 pcs
- Instruction manual
- Warranty



TECHNICAL SPECIFICATION:

Function	Range	Accuracy	
DC Voltage	60.00 mV ... 1000 V	From ±(0.4% of reading + 3 digits) to ±(0.7% of reading + 3 digits)	
AC Voltage (50 Hz ... 500 Hz)	60.00 mV ... 1000 V	From ±(2.0% of reading + 5 digits) to ±(2.2% of reading + 5 digits)	
DC Current	600.0 µA ... 10.00 A	From ±(0.7% of reading + 3 digits) to ±(0.5% of reading + 3 digits)	
AC Current (50 Hz ... 500 Hz)	600.0 µA ... 10.00 A	From ±(2.2% of reading + 5 digits) to ±(1.2% of reading + 5 digits)	
Diode Test	1.000 V	±(1.0% of reading + 3 digits)	
Resistance	600.0 Ω ... 60.00 MΩ	DC, Test current 0.50 mA From ±(0.5% of reading + 6 digits) to ±(1.5% of reading + 5 digits)	
Capacitance	6.000 µF ... 2000 µF	From ±(2.0% of reading + 5 digits) to ±(4.0% of reading + 5 digits)	
Temperature	-50 °C ... 1000 °C -58 °F ... 1832 °F	±(0.5% of reading + 3 digits) ±(0.5% of reading + 6 digits)	
IP-RPM	RPM 4 (240 ... 20000 RPM) RPM 2 (120 ... 10000 RPM) RPM 2M (60 ... 5000 RPM) RPM 4 (60 ... 20000 RPM)	±(2RPM)	
IG-RPM	RPM 4 (60 ... 20000 RPM) RPM 2 (30 ... 10000 RPM) RPM 2M (15 ... 5000 RPM)	±(2RPM)	
Dwell	0.0 ° ... 360.0 ° 0.0 % ... 100.0 %	±(1.2 %/krpm + 1 digit) ±(0.04 %/krpm /cyl + 2 digits)	
Fuel injection-ms detector	PFI / Multi Point Injection 0.05 ms ... 250.0 ms 0.0 % ... 100.0 %	±(0.05 ms + 1 digit) ±(0.04 %/krpm + 2 digits)	
	TBI / Single Point Injection 0.05 ms ... 250.0 ms 0.0 % ... 100.0 %	±(0.05 ms + 1 digit) ±(0.04 %/krpm /cyl + 2 digits)	
Function	Range	Sensitivity (Sin RMS) Accuracy	
Hz (Line-level) @ ACV & DCV	6 V	10 Hz ... 10 kHz	0.5 V
	60 V	10 Hz ... 50 kHz	5 V
	600 V	45 Hz ... 1 kHz	50 V
	1000 V		500 V
Power supply	2 x 1.5 V batteries, type AAA		
Overvoltage category	CAT II / 1000 V		
Dimensions	161 x 80 x 50 mm		
Weight	340 g		

MD 9030 TRMS General Purpose Digital Multimeter

The MD 9030 TRMS digital multimeter has been designed for use both in the laboratories and in the harsh industrial maintenance and repair sector. TRMS functionality makes the multimeter suitable for a multitude of situations, while the large bright screen with backlight and incorrect lead connection alert make it ideal for working in dark areas.

MEASURING FUNCTIONS:

- TRMS AC, DC voltage measurement;
- TRMS AC, DC current measurement;
- Capacitance measurement;
- Resistance measurement;
- Diode test;
- Frequency measurement;
- Continuity test (acoustic signalling);
- Temperature measurement.

KEY FEATURES:

- **TRMS:** accurate readings on sinusoidal and non-sinusoidal signals.
- **Temperature measurement:** measures temperature in Celsius up to 300 °C and in Fahrenheit up to 572 °F.
- **Frequency measurement:** up to 1 MHz.
- **Lead alert:** incorrect lead connection alert.
- **Auto-ranging:** user can switch between auto and manual ranging.
- **Relative zero mode:** relative function for comparing the difference between signals or removing background noise.
- **Data Hold:** data hold feature freezes the display for later view.
- **MAX Hold:** MAX hold feature freezes the maximum measured value.
- **Safe:** CAT IV / 300 V, CAT III / 600 V and CAT II / 1000 V overvoltage protection.
- **Backlight:** large bright 3-3/4 digits, 4000 counts LCD display with backlight for working in dark conditions.

APPLICATION:

- Mid level electrical testing;
- Mid level electronic fault finding;
- Field servicing;
- General purpose.

STANDARD SET:

- Multimeter MD 9030 with rubber holster
- Test lead with probe, 2 pcs
- 1.5 V battery, type AAA, 2 pcs
- Instruction manual
- Warranty



TECHNICAL SPECIFICATION:

Function	Range	Accuracy
DC voltage	400.0 mV ... 1000 V	from ±(0.3 % of reading + 4 digits) to ±(1.0 % of reading + 4 digits)
TRMS AC voltage (50 ... 500 Hz)	400.0 mV ... 1000 V	from ±(1.5 % of reading + 5 digits) to ±(4.0 % of reading + 5 digits)
DC current	400.0 µA ... 10.00 A	from ±(1.2 % of reading + 3 digits) to ±(2.0 % of reading + 5 digits)
TRMS AC current	400.0 µA ... 10.00 A	from ±(1.5 % of reading + 4 digits) to ±(2.0 % of reading + 6 digits)
Diode test	Open-circuit voltage < 1.6 V _{bc} , Test current 0.25 mA	
Resistance	400.0 Ω ... 40.00 MΩ	from ±(0.6 % of reading + 4 digits) to ±(2.0 % of reading + 4 digits)
Temperature	-20 °C ... 300 °C	±(2.0 % of reading + 3 °C)
Frequency	50.00 Hz ... 1.000 MHz	±(0.5 % of reading + 4 digits)
Capacitance	500.0 nF ... 3000 µF	±(3.5 % of reading + 6 digits)
Power supply	2 x 1.5 V batteries, type AAA	
Overvoltage category	CAT IV / 300 V; CAT III / 600 V; CAT II / 1000 V	
Dimensions	198 x 97 x 55 mm	
Weight	396 g	

MD 9020 General Purpose Digital Multimeter

The MD 9020 is a high-quality digital multimeter, designed for everyday use in the laboratory and for maintenance and repair work in the field and in the industrial sector as well.

MEASURING FUNCTIONS:

- AC, DC voltage measurement;
- AC, DC current measurement;
- Capacitance measurement;
- Resistance measurement;
- Diode test;
- Frequency measurement;
- Continuity test (acoustic signalling);
- Temperature measurement.

KEY FEATURES:

- **Temperature measurement:** measures temperature in Celsius up to 300 °C and in Fahrenheit up to 572 °F.
- **Frequency measurement:** up to 1 MHz.
- **Lead alert:** incorrect lead connection alert.
- **Auto-ranging:** user can switch between auto and manual ranging.
- **Relative zero mode:** relative function for comparing the difference between signals or removing background noise.
- **Data Hold:** data hold feature freezes the display for later view.
- **MAX Hold:** MAX hold feature freezes the maximum measured value.
- **Safe:** CAT IV / 300 V, CAT III / 600 V and CAT II / 1000 V overvoltage protection.

APPLICATION:

- Mid level electrical testing;
- Mid level electronic fault finding;
- Field servicing;
- General purpose.

STANDARD SET:

- Multimeter MD 9020 with rubber holster
- Test lead with probe, 2 pcs
- 1.5 V battery, type AAA, 2 pcs
- Instruction manual
- Warranty



TECHNICAL SPECIFICATION:

Function	Range	Accuracy
DC voltage	400.0 mV ... 1000 V	from ±(0.3 % of reading + 4 digits) to ±(1.0 % of reading + 4 digits)
AC voltage (50 ... 500 Hz)	400.0 mV ... 1000 V	from ±(1.5 % of reading + 5 digits) to ±(4.0 % of reading + 5 digits)
DC current	400.0 µA ... 10.00 A	from ±(1.2 % of reading + 3 digits) to ±(2.0 % of reading + 5 digits)
AC current	400.0 µA ... 10.00 A	from ±(1.5 % of reading + 4 digits) to ±(2.0 % of reading + 6 digits)
Diode test	Open-circuit voltage < 1.6 V _{DC} , Test current 0.25 mA	
Resistance	400.0 Ω ... 40.00 MΩ	from ±(0.6 % of reading + 4 digits) to ±(2.0 % of reading + 4 digits)
Temperature	-20 °C ... 300 °C	±(2.0 % of reading + 3 °C)
Frequency	50.00 Hz ... 1.000 MHz	±(0.5 % of reading + 4 digits)
Capacitance	500.0 nF ... 3000 µF	±(3.5 % of reading + 6 digits)
Power supply	2 x 1.5 V batteries, type AAA	
Overvoltage category	CAT IV / 300 V; CAT III / 600 V; CAT II / 1000 V	
Dimensions	198 x 97 x 55 mm	
Weight	396 g	



MD 9016 Electrical Field Service Multimeter

The digital multimeter MD 9016 is a perfect combination of size, innovative functions and built-in PC communication. It is capable to detect and diagnose most electrical and electrotechnical problems. Display with large easy-to-read figures and one-handed operation make MD 9016 an extremely easy-to-use. This compact instrument combines a high level of functionality and small size and portability.

MEASURING FUNCTIONS:

- AC, DC voltage measurement;
- AC, DC current measurement;
- Capacitance measurement;
- Resistance measurement;
- Diode test;
- Frequency measurement;
- Continuity test (acoustic signaling);
- Electric field detection;
- Temperature measurement.

KEY FEATURES:

- **Auto-ranging:** user can switch between auto and manual ranging.
- **EF detection:** non-contact and probe contact electric field detection.
- **Relative zero mode:** relative function for comparing the difference between signals or removing background noise.
- **Hold:** data hold function freezes the display for later view.
- **PC Link:** test results can be downloaded to the computer via the optional PC software.
- **Safe:** CAT II / 1000 V, CAT III / 600 V and CAT IV / 300 V overvoltage protection.

APPLICATION:

- HVAC (heating, ventilation and air conditioning) troubleshooting;
- Low level electrical testing;
- Low level electronic fault finding;
- Basic field servicing;
- Hobby work.

STANDARD SET:

- Multimeter MD 9016 with rubber holster
- Test lead with probe, 2 pcs
- Thermocouple probe, type K
- 1.5 V battery, type AAA, 2 pcs
- Instruction manual
- Warranty

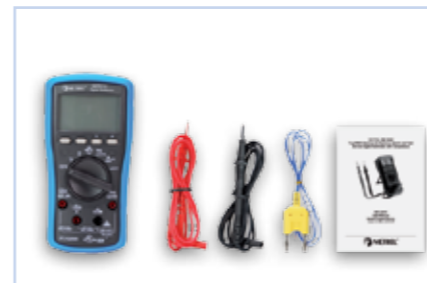

TECHNICAL SPECIFICATION:

Function	Range	Accuracy
DC Voltage	60.00 mV ... 1000 V	from ±(0.4% of reading + 5 digits) to ±(0.2% of reading + 3 digits)
AC Voltage (50 Hz ... 500 Hz)	60.00 mV ... 1000 V	±(1.0% of reading + 5 digits)
DC Current	600.0 µA ... 8.00 A	from ±(0.5% of reading + 5 digits) to ±(1.8% of reading + 6 digits)
AC Current (50 Hz ... 400 Hz)	600.0 µA ... 8.00 A	from ±(1.0% of reading + 3 digits) to ±(1.8% of reading + 6 digits)
Diode Test	1.000 V	±(1.0% of reading + 3 digits)
	Open-circuit voltage < 1.8 V DC, Test current 0.56 mA	
Resistance	600.0 Ω ... 60.00 MΩ	from ±(0.5% of reading + 4 digits) to ±(1.2% of reading + 4 digits)
Capacitance	60.00 nF ... 3000 µF	from ±(1.5% of reading + 5 digits) to ±(2.0% of reading + 5 digits)
Temperature	-50 °C ... 1000 °C	±(0.3% of reading + 3 digits)
	-58 °F ... 1832 °F	±(0.3% of reading + 6 digits)
Frequency of digital equipment	5.00 Hz ... 1.000 MHz	±(0.003% of reading + 2 digits)
Mains frequency	10 Hz ... 50 kHz	±(0.003% of reading + 3 digits)
Power supply	2 x 1.5 V batteries, type AAA	
Overvoltage category	CAT IV / 300 V; CAT III / 600 V; CAT II / 1000 V	
Dimensions	161 x 80 x 50 mm	
Weight	340 g	



MD 9015 Electrical Field Service Digital Multimeter

The digital multimeter MD 9015 includes all necessary functions required to detect and diagnose most electrical and electrotechnical problems. Display with large easily-read figures and one-handed operation make MD 9015 an extremely easy to use. This compact instrument combines a high level of functionality and small size and portability.

MEASURING FUNCTIONS:

- AC, DC voltage measurement;
- AC, DC current measurement;
- Capacitance measurement;
- Resistance measurement;
- Diode test;
- Frequency measurement;
- Continuity test;
- Electric field detection;
- Temperature measurement.

KEY FEATURES:

- **Temperature:** measures temperature in Celsius up to 300 °C and in Fahrenheit up to 572 °F.
- **Auto-ranging:** user can switch between auto and manual ranging.
- **EF detection:** non-contact and probe-contact electric field detection.
- **Relative zero mode:** relative function for comparing the difference between signals or removing background noise.
- **Hold:** data hold function freezes the display for later view.
- **PC Link:** test results can be downloaded to the computer via the optional PC software.
- **Safe:** CAT II / 1000 V, CAT III / 600 V and CAT IV / 300 V overvoltage protection.

APPLICATION:

- HVAC (heating, ventilation and air conditioning) troubleshooting;
- Low level electrical testing;
- Low level electronic fault finding;
- Basic field servicing;
- Hobby work.

STANDARD SET:

- Multimeter MD 9015 with rubber holster
- Test lead with probe, 2 pcs
- 1.5 V battery, type AAA, 2 pcs
- Instruction manual
- Warranty



TECHNICAL SPECIFICATION:

Function	Range	Accuracy
DC voltage	250.0 mV ... 1000 V	from ±(0.3 % of reading + 4 digits) to ±(1.0 % of reading + 4 digits)
AC voltage (50 ... 500 Hz)	250.0 mV ... 750 V	from ±(1.0 % of reading + 3 digits) to ±(2.2 % of reading + 6 digits)
DC current	250.0 µA ... 10.00 A	from ±(0.8 % of reading + 3 digits) to ±(2.0 % of reading + 6 digits)
AC current	250.0 µA ... 10.00 A	from ±(1.0 % of reading + 4 digits) to ±(2.5 % of reading + 5 digits)
Diode test	Open-circuit voltage <1.8 V _{oc} , Test current 1 mA	
Resistance	250.0 Ω ... 25.00 MΩ	from ±(0.4 % of reading + 2 digits) to ±(1.0 % of reading + 4 digits)
Temperature	-20 °C ... 300 °C	3 °C + 3 digits
Frequency	30 Hz ... 200 kHz	±(0.05 % of reading + 4 digits)
Capacitance	2.500 nF ... 25.00 µF	from ±(1.0 % of reading + 4 digits) to ±(6.0 % of reading + 45 digits)
Power supply	2 x 1.5 V batteries, type AAA	
Overvoltage category	CAT IV / 300 V; CAT III / 600 V; CAT II / 1000 V	
Dimensions	160 x 82 x 48 mm	
Weight	345 g	

MD 9010 General Purpose Autocheck Digital Multimeter

The MD 9010 is one of the smallest and lightest of our digital multimeters. The MD 9010 unit can be used for a wide variety of applications. The high accuracy, LCD display and features including non-contact voltage detection and an autocheck function make the multimeter extremely versatile and great value for money.

MEASURING FUNCTIONS:

- AC, DC voltage measurement;
- AC, DC current measurement;
- Capacitance measurement;
- Resistance measurement;
- Diode test;
- Frequency measurement;
- Continuity test;
- Electric field detection.

KEY FEATURES:

- **Autocheck function:** automatic detection of AC voltage, DC voltage or resistance.
- **Auto-ranging:** no need of manual ranging.
- **Pocket-sized:** small, thin, ergonomic design.
- **Lightweight:** 78 g only.
- **Acoustic signalling** on continuity test.
- **EF detection:** non-contact and probe-contact electric field detection.
- **Safe:** protected against wrong connection and overvoltage (CAT III / 300 V and CAT II / 600 V).
- **Easy to read:** LCD display, 3-5/6 digits, 6000 counts.

APPLICATION:

- Low level electrical testing;
- Low level electronic fault finding;
- Basic field servicing;
- Hobby work.

STANDARD SET:

- Multimeter MD 9010 with rubber holster
- Test lead with probe, 2 pcs
- Battery
- Instruction manual
- Warranty



TECHNICAL SPECIFICATION:

Function	Range	Accuracy
DC voltage	6.000 V ... 600.0 V	from ±(0.5 % of reading + 3 digits) to ±(2.0 % of reading + 5 digits)
AC voltage (50 ... 60 Hz)	6.000 V ... 600.0 V	±(1.5 % of reading + 5 digits)
DC current	400.0 µA 2000 µA	±(1.5 % of reading + 3 digits) ±(1.2 % of reading + 3 digits)
AC current	400.0 µA 2000 µA	±(2.0 % of reading + 3 digits) ±(1.5 % of reading + 3 digits)
Diode test	Open-circuit voltage <1.6 V _{oc}	
Resistance	600.0 Ω ... 6.000 MΩ	from ±(1.0 % of reading + 4 digits) to ±(2.0 % of reading + 6 digits)
Frequency	10.00 Hz ... 30.00 kHz	±(0.5 % of reading + 4 digits)
Capacitance	100.0 nF ... 2000 µF	±(3.5 % of reading + 6 digits)
Power supply	3 V button battery (IEC-CR2032)	
Overvoltage category	CAT III / 300 V; CAT II / 600 V	
Dimensions	113 x 53 x 10.2 mm	
Weight	78 g	

Selection Guide for Clamp Meters

Part No.:	MD 9270	MD 9250	MD 9240
True RMS	✓	✓	✓
DC current range	–	2000 A	–
Basic accuracy (%)	–	2.0	–
AC current range	150 A	2000 A	1000 A
Basic accuracy (%)	0.8	2.0	1
DC voltage range	–	1000	600 V
Basic accuracy (%)	–	0.5	0.5
AC voltage range	600 V	1000	600 V
Basic accuracy (%)	0.5	1.2	0.5
Resistance range	–	40.00 MΩ	999.9 Ω
Basic accuracy (%)	–	0.5	1
Acoustic continuity test	–	✓	✓
Diode test	–	✓	–
Capacitance measurement	–	✓	–
Frequency measurement	–	✓	✓
Temperature measurement (Type K probe)	–	✓	✓
Autocheck® V-Ω	–	✓	Auto V-A
Variable frequency drive	–	✓	–
Lo-Z (low input impedance)	–	✓	–
Power measurement (W, VA, VAR)	✓	–	✓
3-Phase Power measurement 3-wire/4-wire	–	–	–
Count	3000	6000	4000, 6000, 9999
Backlight	✓	✓	✓
COM port (data transfer)	–	✓	✓
Automatic and manual range selection	Auto	✓	Auto
Automatic switch off	✓	✓	✓
Non-contact electrical field detection	–	✓	–
MAX hold	✓	✓	–
Peak value	✓	✓	✓
Data hold	✓	✓	✓
Relative value	–	✓	–
Jaw opening	31 mm	55 mm	45 mm
Overvoltage category	CAT IV / 300 V CAT III / 600 V	CAT IV / 1000 V	CAT IV / 300 V CAT III / 600 V
Dimensions (mm)	212 x 59 x 37	264 x 97 x 43	224 x 78 x 40
Weight (g)	225	608	224
CE mark	✓	✓	✓

MD 9235	MD 9230	MD 9225	MD 9220	MD 9210
✓	✓	✓	✓	–
–	1000 A	400 A	–	–
–	1.5	1	–	–
600 A	800 A	400 A	2000 A	600 A
1	1.5	1	1.5	1.5
600 V	600 V	600 V	600 V	600 V
0.5	0.3	0.3	0.5	0.3
600 V	600 V	600 V	600 V	600 V
0.5	1	1	1.5	1.5
999.9 Ω	40.00 MΩ	40.00 MΩ	6.000 MΩ	40.00 MΩ
1	0.6	0.8	1	0.6
✓	✓	✓	✓	✓
–	✓	✓	✓	✓
–	✓	✓	✓	✓
✓	–	✓	✓	✓
–	–	✓	–	–
–	–	Auto V-A	✓	–
–	–	–	–	–
–	–	–	–	–
✓	–	–	–	–
6000	4000	4000	6000	4000
✓	✓	✓	✓	–
✓	–	–	–	–
Auto	✓	Auto	✓	Auto
–	✓	✓	✓	✓
–	–	–	✓	–
–	✓	✓	–	✓
✓	–	–	–	–
✓	✓	✓	✓	✓
–	✓	✓	–	✓
26 mm	50 mm	26 mm	45 mm	26 mm
CAT IV / 300 V CAT III / 600 V	CAT IV / 300 V CAT III / 600 V	CAT IV / 300 V CAT III / 600 V	CAT IV / 300 V CAT III / 600 V	CAT IV / 300 V CAT III / 600 V
189 x 78 x 40	227 x 78 x 40	188 x 63 x 40	224 x 78 x 40	190 x 63 x 32
192	290	192	220	139
✓	✓	✓	✓	✓

MD 9270 Leakage Clamp TRMS Meter with Power Functions

The MD 9270 is a unique earth leakage clamp meter. It not just has the ability to accurately read the TRMS AC leakage current of a system, it can also detect losses in the system and suggest possible reasons for the loss. The voltage, power, harmonic, power factor (PF), total harmonic distortion (THD) and crest factor measurements make this instrument suitable for any electrician and engineer.

MEASURING FUNCTIONS:

- TRMS AC voltage measurement;
- TRMS AC current measurement;
- Power parameters measurement.

KEY FEATURES:

- **TRMS:** accurate measurements on sinusoidal and non-sinusoidal signals.
- **Jaw size:** 31 mm.
- **Shielded Jaw:** shielded jaw allows the clamp meter to be used in the noisiest environments.
- **Accurate:** readings of AC current with an accuracy of 0.8 % and a base resolution of 0.01 mA and voltage with an accuracy of 0.5 % and a base resolution of 0.1 V.
- **Power:** measures various power parameters (active, reactive, apparent power, THD, PF, phase displacement).
- **Intelligent loss analysis:** complex algorithms detect loss and allow determining possible reasons for current loss.
- **Harmonics:** measures current or voltage harmonic components and a percentage value of a harmonic up to the 49th.
- **THD and PF:** dual display allows readings to be displayed along with Total Harmonic Distortion (THD) or Power Factor (PF).
- **Peak value:** the peak value of the waveform or crest factor can be displayed.
- **MAX/MIN/HOLD mode:** displays maximum, minimum or average measured value.



APPLICATION:

- Load and leakage current measurement;
- System maintenance;
- Power system checking;
- RCD fault finding;
- Process engineering.

STANDARD SET:

- Current clamp MD 9270
- Test lead with probe, 2 pcs
- 1.5 V battery, type AAA, 2 pcs
- Pouch
- Instruction manual
- Warranty

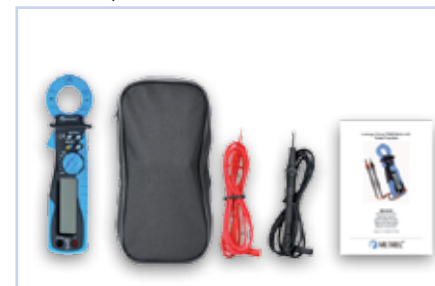

TECHNICAL SPECIFICATION:

Function	Range	Accuracy
AC current	40.00 mA, 400.0 mA, 4000 mA	±(0.8 % of reading + 3 digits)
	40.00 A	±(1.0 % of reading + 3 digits)
	150.0 A	±(2.0 % of reading + 5 digits)
AC voltage	250.0 V, 600.0 V	±(0.5 % of reading + 2 digits)
	0 ... 99.9 % 100 ... 999 %	±(2.0 % of reading + 3 digits) ±(2.0 % of reading + 3 digits)
THD	1.00 ... 2.99	±(2.0 % of reading + 2 digits)
	3.00 ... 9.99	±(3.0 % of reading + 5 digits)
Crest Factor	0 ... 150.0 A	±(3.0 % of reading + 3 digits)
	0 ... 600.0 V	±(3.0 % of reading + 3 digits)
Power factor (PF)	0.00 ... 1.00	±(1.0 % of reading + 0.01)
Phase	-180.0° ... +180.0°	±(1.0 % of reading + 0.4)
Apparent power	0 ... 9999 VA	from ±(1% of r. + 0.03) to ±(1% of r. + 3)
	10 kVA ... 999.9 kVA	from ±(2% of r. + 0.03) to ±(2% of r. + 0.3)
Active power	0 ... 9999 W	from ±(1% of r. + 0.03) to ±(1% of r. + 3)
	10 kW ... 999.9 kW	from ±(2% of r. + 0.03) to ±(2% of r. + 0.3)
Reactive power	0 ... 9999 VAR	from ±(1% of r. + 0.03) to ±(1% of r. + 3)
	10 kVAR ... 999.9 kVAR	from ±(2% of r. + 0.03) to ±(2% of r. + 0.3)
Power supply	2 x 1.5 V batteries, type AAA	
Overvoltage category	CAT IV / 300 V; CAT III / 600 V	
Dimensions	212 x 59 x 37 mm	
Weight	225 g	

MD 9250 Industrial TRMS AC/DC CAT IV /1000 V

The MD 9250 is the first Clamp Meter that meets overvoltage category CAT IV 1000 V. MD 9250 is a high quality clamp meter specially designed for single-hand operation, built-in measuring functions; TRMS AC/DC (current, voltage), capacitance, temperature and full range resistance makes this instrument an ideal tool for the most demanding applications in the industrial sector. The large jaws capacity of (max. 55 mm) in diameter allows AC/DC - current measurements up to 2000 A. High resolution and accuracy, 2-line LCD display fast data acquisition and transfer (via optical interface), non-contact voltage detection, and auto-check function are highlights of the instrument.

MEASURING FUNCTIONS:

- TRMS AC, DC voltage measurement;
- TRMS AC, DC current measurement;
- Capacitance measurement;
- Resistance measurement;
- Diode test;
- Frequency measurement;
- Electric field detection;
- Continuity test (acoustic signaling);
- Temperature measurement.

KEY FEATURES:

- **Large jaws:** for measuring on 55mm size conductors.
- **TRMS:** accurate measurements on sinusoidal and non-sinusoidal signals.
- **VFD:** feature makes the instrument capable of measuring the true values in accordance with frequency.
- **High current:** 2000 A DC & AC clamp on measurement.
- **Lo-Z:** AutoCheck® mode provides low (ramp-up) input impedance to drain ghost voltages.
- **Auto-check function:** automatic detection of AC voltage, DC voltage or resistance.
- **Auto-ranging:** user can switch between auto and manual ranging.
- **Transient protection:** it protects user in case of lightning strike or switching surge up to 12 kV.
- **Relative zero mode:** relative function for comparing the difference between signals or removing background noise.
- **PC Link:** test results can be downloaded to the computer via the optional PC software.
- **In-rush:** fast 5ms Crest-MAX mode to capture in-rush currents.
- **Temperature:** measures temperature in Celsius up to 1000 °C and in Fahrenheit up to 1832 °F.
- **Hold:** data hold function freezes the display for later view.
- **Backlight:** large bright 3-5/6 digits 6,000 counts + 1,999 counts dual LCD display with backlight for working in dark conditions.
- **Safe:** CAT IV / 1000 V overvoltage protection.

APPLICATION:

- Solar and wind power system testing;
- UPS system testing;
- Utility scale battery system testing;
- High level industrial testing;
- High level electrical testing.

STANDARD SET:

- Current clamp MD 9250
- Test lead with probe, 2 pcs
- Thermocouple probe, type K
- Pouch
- 1.5 V battery, type AAA, 2 pcs
- Instruction manual
- Warranty



TECHNICAL SPECIFICATION:

Function	Range	Accuracy
DC Voltage	6.000 V ... 1000 V	±(0.5% of reading + 5 digits)
Autocheck (DCV)	6.000 V ... 1000 V	±(1.3% of reading + 5 digits)
AC Voltage (50 Hz ... 400 Hz)	6.000 V ... 1000 V	±(1.2% of reading + 5 digits)
AC+DC Voltage (DC, 50Hz ... 400 Hz)	6.000 V ... 1000 V	±(1.4% of reading + 7 digits)
Autocheck (ACV)	6.000 V ... 1000 V	±(1.5% of reading + 5 digits)
Variable Frequency Drive AC	10 Hz ... 400 Hz	from ±(4.0% of reading + 80 digits) to ±(7.0% of reading + 80 digits)
DC Current	200.0 A ... 2000 A	From ±(2.0% of reading + 5 digits) to ±(2.5% of reading + 5 digits)
AC Current (50 Hz ... 400 Hz)	200.0 A ... 2000 A	from ±(2.0% of reading + 5 digits) to ±(3.5% of reading + 5 digits)
Diode Test	1.000 V Open-circuit voltage < 1.8 V DC, Test current 0.56 mA	±(1.0% of reading + 3 digit)
Resistance & Autocheck	600.0 Ω ... 40.00 MΩ	from ±(0.5% of reading + 5 digits) to ±(2.3% of reading + 5 digits)
Capacitance	60.00 nF ... 2000 μF	from ±(2.0% of reading + 5 digits) to ±(4.0% of reading + 5 digits)
Temperature	-50 °C ... 1000 °C -58 °F ... 1832 °F	±(0.3% of reading + 4 digits) ±(0.3% of reading + 6 digits)
Mains frequency	10 Hz ... 1999 Hz	±(0.1% of reading + 4 digits)
Power supply	2 x 1.5 V batteries, type AA	
Overvoltage category	CAT IV / 1000 V	
Dimensions	264 x 97 x 43 mm	
Weight	608 g	

MD 9240 TRMS Power Clamp Meter

The MD 9240 is a high-quality and extremely easy to handle power clamp meter. The MD 9240 enables TRMS AC current measurement up to 1000 A, AC and DC voltage measurement, single-phase power analysis, temperature measurement and more. As a result the current clamp meter is suitable for maintenance and checking of distribution systems, switchboards and motors or systems where the supply network is heavily contaminated with harmonics.

MEASURING FUNCTIONS:

- TRMS AC, DC voltage measurement;
- TRMS AC current measurement;
- Frequency measurement;
- Resistance measurement;
- Continuity test;
- Temperature measurement;
- Power parameters measurement.

KEY FEATURES:

- **TRMS:** accurate measurements on sinusoidal and non-sinusoidal signals.
- **Jaw size:** 45 mm.
- **High current:** measures up to 1000 A AC.
- **Autocheck function:** automatic detection of AC voltage, DC voltage or AC current.
- **Power:** measures various power parameters (active, reactive, apparent power, PF).
- **Temperature:** measures temperature in Celsius up to 300 °C and in Fahrenheit up to 572 °F.
- **PC Link:** test results can be downloaded to the computer via the optional PC software.
- **Data Hold:** data hold feature freezes the display for later view.
- **Peak Hold:** peak hold feature displays maximum RMS value of surge voltage or current.



APPLICATION:

- System maintenance;
- Power system checking;
- High level Industrial testing;
- High level electrical testing.

STANDARD SET:

- Current clamp MD 9240
- Test lead with probe, 2 pcs
- Thermocouple probe, type K
- 1.5 V battery, type AAA, 2 pcs
- Pouch
- Instruction manual
- Warranty

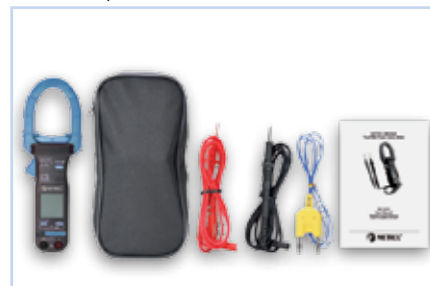

TECHNICAL SPECIFICATION:

Function	Range	Accuracy
DC voltage	600.0 V	±(0.5 % of reading + 5 digits)
AC voltage (50 ... 60 Hz; 45 ... 500 Hz; 500 Hz ... 3.1 kHz)	600.0 V	from ±(0.5 % of reading + 5 digits), to ±(2.5 % of reading + 5 digits)
AC current (50 ... 60 Hz)	40.00 A, 400.0 A, 1000 A	±(1.0 % of reading + 5 digits)
AC current (45 ... 500 Hz)	40.00 A, 400.0 A, 1000 A	±(2.0 % of reading + 5 digits) ±(2.5 % of reading + 5 digits)
AC current (500 Hz ... 3.1 kHz)	40.00 A, 400.0 A, 1000 A	±(2.5 % of reading + 5 digits) ±(3.0 % of reading + 5 digits)
Temperature	-50 °C ... 300 °C	±(2.0 % of reading + 3 °C)
Resistance	999.9 Ω	±(1.0 % of reading + 6 digits)
Continuity test	10 ... 300 Ω	
Frequency	5.00 Hz ... 500.0 Hz	±(0.5 % of reading + 4 digits) ±(3 digits), H from 1. to 21.
Power factor (PF)	0.10 ... 0.99	±(5 digits), H from 22. to 51.
Apparent power	0 ... 600.0 kVA	±(2.0 % of reading + 6 digits), H 1./10. ±(3.5 % of reading + 6 digits), H 11./46. ±(5.5 % of reading + 6 digits), H 47./51.
Active power, reactive power	0 ... 600.0 kW, kVar	from ±(2.0 % of reading + 6 digits)
Power supply	2 x 1.5 V batteries, type AAA	
Overvoltage category	CAT IV / 300 V; CAT III / 600 V	
Dimensions	224 x 78 x 40 mm	
Weight	224 g	

MD 9235 TRMS Power Clamp Meter, 3-Phase, Unbalanced-Load

The MD 9235 is a Slim-Jaw current clamp meter with ability to measure 3-Phase Unbalanced-Load + kWhr recording. The MD 9235 enables TRMS AC current measurement up to 600 A, single and 3-phase power analysis, total power factor and resistance measurement. Display with large easy-to-read figures and one-handed operation make MD 9235 an extremely easy-to-use. This compact instrument combines a high level of functionality, small size and portability. All built-in features make MD 9235 a perfect tool for advanced Power applications.

MEASURING FUNCTIONS:

- TRMS AC, DC voltage measurement;
- TRMS AC current measurement;
- Resistance measurement;
- Frequency measurement;
- Continuity test (acoustic signaling);
- Power parameters measurement.

KEY FEATURES:

- **Slim-Jaws:** ultra-slim jaws to access tight places.
- **TRMS:** accurate measurements on sinusoidal and non-sinusoidal signals.
- **kWhr:** Kilo-Watt-Hour recording function (with memory recal).
- **Peak Hold:** peak hold feature displays maximum RMS value of surge voltage or current.
- **Jaw size:** 26 mm.
- **Transient protection:** it protects user in case of lightning strike or switching surge up to 6.5 Kv.
- **PC Link:** test results can be downloaded to the computer via the optional PC software.
- **Hold:** data hold function freezes the display for later view.
- **Safe:** CAT IV / 300 V, CAT III / 600 V overvoltage protection.



APPLICATION:

- Power system checking;
- High level industrial testing;
- High level electrical testing.

STANDARD SET:

- Current clamp MD 9235
- Test lead with probe, 2 pcs
- Pouch
- 1.5 V battery, type AAA, 2 pcs
- Instruction manual
- Warranty

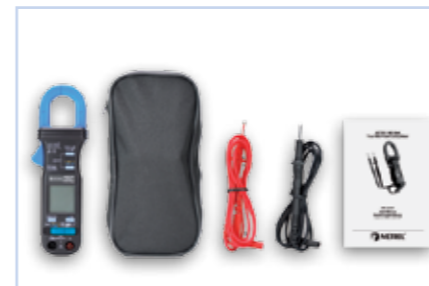

TECHNICAL SPECIFICATION:

Function	Range	Accuracy
DC Voltage	600.0 V	±(0.5% of reading + 5 digits)
AC Voltage (50 Hz ... 3.1 kHz)	600.0 V	from ±(0.5% of reading + 5 digits) to ±(2.5% of reading + 5 digits)
AC Current (40 Hz ... 3.1 kHz)	40.00 A ... 600 A	from ±(1.0% of reading + 5 digits) to ±(3.0% of reading + 5 digits)
Resistance	999.9 Ω	±(1.0% of reading + 6 digits)
Apparent power	0 kVA ... 600.0 kVA	±(2.0% of reading + 6 digits), H 1./10. ±(3.5% of reading + 6 digits), H 11./46. ±(5.5% of reading + 6 digits), H 46./51.
Active power, reactive power	0 kVA ... 600.0 kW, kVar	from ±(2.0% of reading + 6 digits) to ±(10.0% of reading + 6 digits), H 1./10. from ±(3.5% of reading + 6 digits) to ±(10.0% of reading + 6 digits), H 11./25. from ±(4.5% of reading + 6 digits) to ±(15.0% of reading + 6 digits), H 26./45. from ±(10.0% of reading + 6 digits) to ±(15.0% of reading + 6 digits), H 46./51.
Power factor (PF)	0.10 ... 0.99	±(3 digits), H 1./21. ±(5 digits), H 22./51.
Mains frequency	5 Hz ... 500 Hz	±(0.5% of reading + 4 digits)
Power supply	2 x 1.5 V batteries, type AAA	
Overvoltage category	CAT IV / 300 V, CAT III / 600 V	
Dimensions	189 x 78 x 40 mm	
Weight	192 g	

MD 9230 Industrial TRMS AC/DC Current Clamp Meter

The MD 9230 is a universal current clamp for measuring DC and TRMS AC voltages up to 600 V and DC and TRMS AC currents up to 1000 A. With a broad spectrum of measuring functions and features, it is an ideal tool for service companies and works electricians in the industrial sector.

MEASURING FUNCTIONS:

- TRMS AC, DC voltage measurement;
- TRMS AC, DC current measurement;
- Resistance measurement;
- Continuity testing;
- Capacitance measurement;
- Diode test.

KEY FEATURES:

- **TRMS:** accurate measurements on sinusoidal and non-sinusoidal signals.
- **Jaw size:** 50 mm.
- **High current:** measures up to 800 A AC and 1000 A DC.
- **Auto-ranging:** user can switch between auto and manual ranging.
- **Relative zero mode:** relative function for comparing the difference between signals or removing background noise.
- **Data Hold:** data hold feature freezes the display for later view.
- **MAX Hold:** MAX hold feature freezes the maximum measured value.
- **Display:** easy to read LCD screen, 3-3/4 digits, 4000 counts with backlight.

APPLICATION:

- Solar and wind power systems testing;
- UPS systems testing;
- Utility scale battery systems testing;
- High level industrial testing;
- High current electrical testing.

STANDARD SET:

- Current clamp MD 9230
- Test lead with probe, 2 pcs
- 1.5 V battery, type AAA, 2 pcs
- Pouch
- Instruction manual
- Warranty

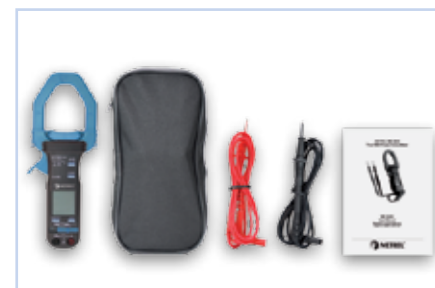

TECHNICAL SPECIFICATION:

Function	Range	Accuracy
DC voltage	400.0 mV, 4.000 V, 40.00 V, 400.0 V, 600.0 V	±(0.3 % of reading + 3 digits) ±(0.5 % of reading + 3 digits) ±(1.0 % of reading + 4 digits)
AC voltage	50 Hz ... 500 Hz 50 Hz ... 60 Hz 60 Hz ... 500 Hz 50 Hz ... 500 Hz	400.0 mV 4.000 V, 40.00 V, 400.0 V 4.000 V, 40.00 V, 400.0 V 600 V
DC current	400.0 A, 1000 A	±(4.0 % of reading + 4 digits) ±(1.0 % of reading + 4 digits) ±(1.5 % of reading + 4 digits) ±(2.0 % of reading + 4 digits)
AC current (15 Hz ... 1 kHz)	400 A, 800 A	from ±(1.5 % of reading + 4 digits) to ±(5.0 % of reading + 30 digits)
Resistance	400.0 Ω ... 40.00 MΩ	from ±(0.6 % of reading + 4 digits) to ±(2.0 % of reading + 4 digits)
Continuity test	400.0 Ω	±(1.5 % of reading + 6 digits)
Diode test	Open-circuit voltage < 1.6 V _{DC} , test current 0.4 mA	
Capacitance	500 nF ... 3000 μF	±(3.5 % of reading + 6 digits)
Power supply	2 x 1.5 V batteries, type AAA	
Overvoltage category	CAT IV / 300 V; CAT III / 600 V	
Dimensions	227 x 78 x 40 mm	
Weight	290 g	

MD 9225 Most Complete Industrial TRMS AC/DC Current Clamp Meter

The MD 9225 is a versatile current clamp meter with perfect combination of size and built-in functions. It measures AC/DC current and voltage, capacitance, temperature, full range resistance and captures in-rush current. Display with large easy-to-read figures and one-handed operation make MD 9225 an extremely easy-to-use. This compact instrument combines a high level of functionality, small size and portability. All built-in features make MD 9225 a perfect tool for advanced applications.

MEASURING FUNCTIONS:

- TRMS AC, DC voltage measurement;
- TRMS AC, DC current measurement;
- Capacitance measurement;
- Resistance measurement;
- Diode test;
- Frequency measurement;
- Continuity test (acoustic signaling);
- Temperature measurement.

KEY FEATURES:

- **Clamp on + Full Multimeter ranges:** measures current up to 400 A AC/DC.
- **Jaw size:** 26 mm.
- **In-rush:** fast 30 ms Crest-MAX mode to capture in-rush currents.
- **Temperature:** measures temperature in Celsius up to 537 °C and in Fahrenheit up to 999 °F.
- **Transient protection:** it protects user in case of lightning strike or switching surge up to 6.5 kV.
- **High resolution:** 4000 counts enable fast measurements.
- **Relative zero mode:** relative function for comparing the difference between signals or removing background noise.
- **Hold:** data hold function freezes the display for later view.
- **Safe:** CAT IV / 300 V, CAT III / 600 V overvoltage protection.

APPLICATION:

- Solar and wind power system testing;
- UPS system testing;
- Utility scale battery system testing;
- Working in small enclosures.

STANDARD SET:

- Current clamp MD 9225
- Test lead with probe, 2 pcs
- Thermocouple probe, type K
- Pouch
- 1.5 V battery, type AAA, 2 pcs
- Instruction manual
- Warranty

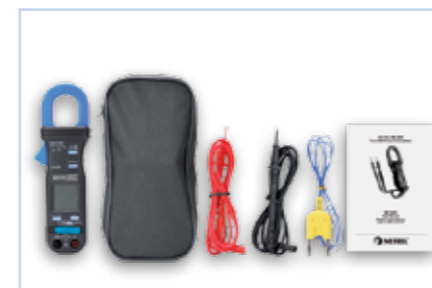

TECHNICAL SPECIFICATION:

Function	Range	Accuracy
DC Voltage	400.0 mV ... 600 V	From ±(0.3% of reading + 3 digits) to ±(1.0% of reading + 4 digits)
AC Voltage (50 Hz ... 500 Hz)	4.000 V ... 600 V	From ±(1.0% of reading + 4 digits) to ±(2.0% of reading + 4 digits)
DC Current	0.0 A ... 400.0 A	From ±(1.0% of reading + 4 digits) to ±(2.5% of reading + 5 digits)
AC Current (40 Hz ... 400 Hz)	0 A ... 400 A	From ±(1.0% of reading + 6 digits) to ±(2.5% of reading + 5 digits)
Diode Test	Open-circuit voltage < 1.6 V DC, Test current 0.4 mA	
Resistance	400.0 Ω ... 40.00 MΩ	From ±(0.8% of reading + 6 digits) to ±(2.0% of reading + 4 digits)
Capacitance	500.0 nF ... 3000 μF	±(3.5% of reading + 6 digits)
Temperature	-20 °C ... 537 °C	From ±(2.0% of reading + 3 digits) to ±(3.0% of reading + 3 digits)
	-4 °F ... 1000 °F	From ±(2.0% of reading + 6 digits) to ±(3.0% of reading + 6 digits)
Mains frequency	5 Hz ... 100 kHz	±(0.5% of reading + 4 digits)
Power supply	2 x 1.5 V batteries, type AAA	
Overvoltage category	CAT IV / 300 V, CAT III / 600 V	
Dimensions	188 x 63 x 40 mm	
Weight	218 g	

MD 9220 TRMS Current Clamp Meter

The MD 9220 is a high-quality TRMS current clamp meter, designed for everyday use in the laboratories and for maintenance and repair work in the field and in the industrial sector.

MEASURING FUNCTIONS:

- TRMS AC, DC voltage measurement;
- TRMS AC current measurement;
- Frequency measurement;
- Resistance measurement;
- Continuity testing;
- Capacitance measurement;
- Diode test;
- Electric field detection.

KEY FEATURES:

- **TRMS:** accurate measurements on sinusoidal and non-sinusoidal signals.
- **Jaw size:** 45 mm.
- **High specification:** readings up to 2000 A with excellent accuracy.
- **Autocheck function:** automatic detection of AC voltage, DC voltage or resistance.
- **Auto-ranging:** user can switch between auto and manual ranging.
- **EF detection:** non-contact and probe-contact electric field detection.
- **Data Hold:** data hold feature freezes the display for later view.
- **Easy to read:** large bright LCD screen, 3-5/6 digits, 6000 counts, with backlight.

APPLICATION:

- High powered 3-phase machinery testing;
- High level industrial testing;
- High current electrical testing.

STANDARD SET:

- Current clamp MD 9220
- Test lead with probe, 2 pcs
- 1.5 V battery, type AAA, 2 pcs
- Pouch
- Instruction manual
- Warranty

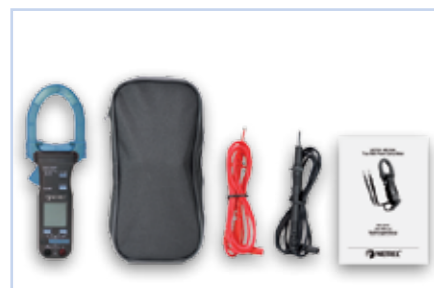

TECHNICAL SPECIFICATION:

Function	Range	Accuracy
DC voltage	6.000 V	±(0.5 % of reading + 3 digits)
	60.00 V	±(1.0 % of reading + 5 digits)
	600.0 V	±(2.0 % of reading + 5 digits)
AC voltage (50, 60 Hz)	6.000 V, 60.00 V	±(1.5 % of reading + 5 digits)
	600.0 V	±(2.0 % of reading + 5 digits)
AC voltage (50 ... 500 Hz)	6.000 V, 60.00 V	±(2 % of reading + 5 digits)
	600.0 V	±(2.5 % of reading + 5 digits)
AC current (50, 60 Hz)	400.0 A, 2000 A	±(1.5 % of reading + 5 digits)
Resistance	6.000 kΩ	±(1.2 % of reading + 6 digits)
	60.00 kΩ, 600.0 kΩ	±(1.0 % of reading + 4 digits)
	6.000 MΩ	±(2.0 % of reading + 4 digits)
Continuity test	600.0 Ω	±(2.0 % of reading + 8 digits)
Diode test	Open-circuit voltage <1.6 V _{DC} , test current 0.4 mA	
Frequency	10 Hz ... 30 kHz	±(0.5% of reading + 4 digits)
Capacitance	100.0 nF ... 2000 μF	±(3.5% of reading + 5 digits)
Power supply	2 x 1.5 V batteries, type AAA	
Overvoltage category	CAT IV / 300 V; CAT III / 600 V	
Dimensions	224 x 78 x 40 mm	
Weight	220 g	

MD 9210 Mini Clamp Meter

Versatility, sturdy case, high accuracy and lots of measurement functions are key features of the current clamp MD 9210. This universal current clamp offers good value for money.

MEASURING FUNCTIONS:

- AC, DC voltage measurement;
- AC current measurement;
- Frequency measurement;
- Resistance measurement;
- Continuity testing;
- Capacitance measurement;
- Diode test.

KEY FEATURES:

- **Jaw size:** 26 mm.
- **Lightweight:** 139 g only.
- **High specification:** readings up to 600 A with excellent accuracy.
- **Auto-ranging:** no need of manual ranging.
- **Relative zero mode:** relative function for comparing the difference between signals or removing background noise.
- **Data Hold:** data hold feature freezes the display for later view.
- **MAX Hold:** MAX hold feature freezes the maximum measured value.
- **Easy to read:** large bright 3-3/4 digits 4000 counts LCD display.

APPLICATION:

- Working in small enclosures;
- General purpose;
- 3-phase machinery testing.

STANDARD SET:

- Current clamp MD 9210
- Test lead with probe, 2 pcs
- 3 V battery
- Pouch
- Instruction manual
- Warranty

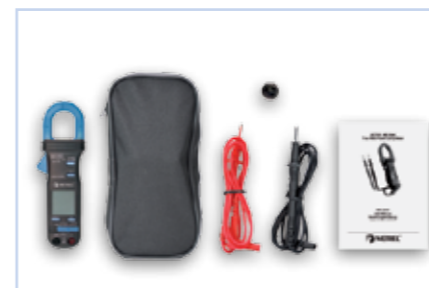

TECHNICAL SPECIFICATION:

Function	Range	Accuracy
DC voltage	400.0 mV	±(0.3 % of reading + 4 digits)
	4.000 V, 40.00 V, 400.0 V	±(0.5 % of reading + 3 digits)
	600 V	±(1.0 % of reading + 4 digits)
AC voltage (50 Hz ... 500 Hz)	4.000 V, 40.00 V, 400.0 V	±(1.5 % of reading + 5 digits)
	600 V	±(2.0 % of reading + 5 digits)
AC current (50 / 60 Hz)	40.00 A, 400.0 A, 600 A	±(1.5 % of reading + 8 digits)
Resistance	400.0 Ω	±(0.8 % of reading + 8 digits)
	4.000 kΩ, 40.00 kΩ, 400.0 kΩ	±(0.6 % of reading + 4 digits)
	4.000 MΩ	±(1.0 % of reading + 4 digits)
	40.00 MΩ	±(2.0 % of reading + 4 digits)
Diode test	Open-circuit voltage <1.6 V _{DC} , test current 0.25 mA	
Frequency	10 Hz ... 100 kHz	±(0.5% of reading + 4 digits)
Capacitance	500.0 nF ... 3000 μF	±(3.5% of reading + 6 digits)
Power supply	3 V battery (IEC-CR2032)	
Overvoltage category	CAT IV / 300 V; CAT III / 600 V	
Dimensions	190 x 63 x 32 mm	
Weight	139 g	

Selection Guide for Voltage detectors

Part No.:	NEW MD 1155	NEW MD 1055
AC VOLTAGE		
Test Range	3 V ÷ 1000 V	6 V ÷ 1000 V
Operation time	Max. 30s	Max. 30s
Response Time	<1s	<1s
Frequency Range	0 ÷ 1000 Hz	0 ÷ 1000 Hz
DC VOLTAGE		
Test Range	4 V ÷ 1400 V	6 V ÷ 1400 V
Operation time	Max. 30s	Max. 30s
Response Time	<1s	<1s
RESISTANCE & CONTINUITY TEST		
Indication	Acoustical and LCD indication	Acoustical and LED indication
Resistance range	0 ÷ 2 kΩ ± 5%	0 - 50 kΩ
Continuity test (Acoustic)	Up to 50Ω	Up to 50Ω
Test current	80uA	8uA
RCD TRIGGER TEST		
RCD fault test	for tripping 30 mA RCD (max 240V)	for tripping 30 mA RCD (max 240V)
Phase TESTING		
Phase Testing	Single-Pole Phase testing	Single-Pole Phase testing
Phase Sequence	Two-Pole Phase Sequence testing	Two-Pole Phase Sequence testing
Phase indication	>100 V AC	>100 V AC
DISPLAY		
Type	3 digit, LC display with backlight	LED bargraph
Tolerance	6 V ÷ 1000 V ±(2% rdg. + 3D)	12 V, 24 V, 48 V, 120 V, 230 V, 400 V, 690 V, 1000 V
TORCH LAMP	LED	LED
SAFETY & PROTECTION		
Overload Category	CAT IV 1000 V	CAT IV 1000 V
Compliant to standards	IEC/EN 61243-3, DIN VDE 0682-401	IEC/EN 61243-3, DIN VDE 0682-401
Protection degree	IP65 For outdoor use: Water jet and dust tight protection	IP65 For outdoor use: Water jet and dust tight protection
TEMPERATURE RANGE	-10 ÷ + 55 °C	-10 ÷ + 55 °C
POWER SUPPLY		
Battery type	2 x 1,5 V Type AAA Micro	2 x 1,5 V Type AAA Micro
DIMENSIONS		
	300 x 75 x 20 mm 270 g	300 x 75 x 20 mm 270 g

MD 1155 LCD Voltage / Continuity Tester

The MD 1155 is a high-quality voltage / continuity tester designed for the most demanding duties. With a broad spectrum of measurement functions and CAT IV / 1000 V overvoltage category, the device is suitable for both the industrial sector and for everyday maintenance and repair practice.

MEASURING FUNCTIONS:

- AC, DC voltage testing;
- Phase testing;
- Rotary field testing;
- Continuity testing;
- RCD trip-out test.

KEY FEATURES:

- 3 V ... 1000 V AC TRMS voltage range.
- 4 V ... 1400 V DC voltage range.
- Data hold function.
- LCD display with backlight.
- Phase rotation measurement.
- RCD trip-out test (max. nominal differential current - 30 mA).
- Optical and acoustic continuity test.
- LED torch lamp.
- Automatic switch off.
- CAT IV / 1000 V overvoltage protection.

APPLICATION:

- Mid level electrical testing;
- Mid level electronic fault finding;
- Field servicing;
- General purpose.

STANDARD SET:

- Voltage tester MD 1155
- 1.5 V battery, type AAA, 2 pcs
- Captive test probe protection
- Plastic probe guard (in accordance with GS38)
- Instruction manual
- Warranty



TECHNICAL SPECIFICATION:

Function	Range
Nominal voltage range	3 V ... 1000 V AC TRMS (automatic range selection)
Nominal voltage range	4 V ... 1400 V DC (automatic range selection)
Frequency range	0 ... 1000 Hz
Resistance range	0 ... 2 kΩ
RCD test current	30 mA
Phase indication	>100 V _{AC}
Phase rotation determination	100 V ... 1000 V, 2-pole
Reaction time	< 0.1 s
Display	3-1/2 digit LCD display with backlight
Power supply	2 x 1.5 V batteries, type AAA
Overvoltage category	CAT IV / 1000 V
Dimensions	300 x 75 x 20 mm
Weight	270 g

MD 1055 LED Voltage / Continuity Tester

The MD 1055 is a multifunction voltage / continuity tester. Because of its broad spectrum of measurement functions, it is suitable for use both in the home and in trade and industrial sectors.

MEASURING FUNCTIONS:

- AC, DC voltage testing;
- Phase testing;
- Rotary field testing;
- Continuity testing;
- RCD trip-out test.

KEY FEATURES:

- 6 V ... 1000 V AC voltage range.
- 6 V ... 1400 V DC voltage range.
- Phase rotation measurement.
- RCD trip-out test (max. nominal differential current - 30 mA).
- Optical and acoustic continuity test.
- LED torch lamp.
- CAT IV / 1000 V overvoltage protection.

APPLICATION:

- General purpose;
- Electrical testing.

STANDARD SET:

- Voltage tester MD 1055
- 1.5 V battery, type AAA, 2 pcs
- Captive test probe protection
- Plastic probe guard (in accordance with GS38)
- Instruction manual
- Warranty

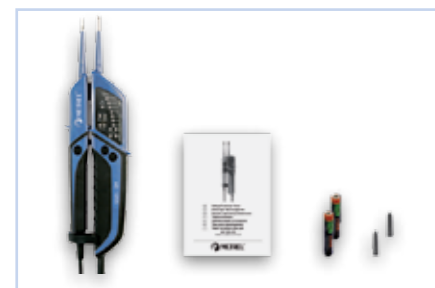

TECHNICAL SPECIFICATION:

Function	Range
Display	16 red LEDs for voltage, continuity, polarity and phase rotation measurement
Nominal voltage range	12 V, 24 V, 48 V, 120 V, 230 V, 400 V, 690 V, 1000 V (automatic range selection)
Frequency range	0 ... 1000 Hz
Resistance range	0 ... 50 kΩ
RCD test current	30 mA
Phase indication	>100 V _{AC}
Phase rotation determination	100 V ... 1000 V, 2-pole
Reaction time	< 0.1 s
Power supply	2 x 1.5 V batteries, type AAA
Overvoltage category	CAT IV / 1000 V
Dimensions	300 x 75 x 20 mm
Weight	270 g

MD 115 Non Contact Voltage Detector

The MD 115 is a non-contact voltage tester that features a visual display, vibrating indicator and comes complete with a pocket clip. It is easy to operate and can be used for a wide variety of jobs; this is an essential tool for both home handymen and professionals. The tester can detect an invisible break within an extension cable with an accuracy of just a few millimeters. A defective bulb in a chain of lights can be located within seconds. Live-voltage wires (e.g., in cable plugs, cable drums, sockets, switches and junction boxes) can also be quickly detected.

MEASURING FUNCTIONS:

- Non contact voltage detection from 12 V AC;
- High performance LED flashlight;
- Vibration alert in case of power.

KEY FEATURES:

- 12 V ... 1000 V AC measurement range;
- Optical and vibrating indication;
- CAT III / 1000 V overvoltage protection.

APPLICATION:

- General purpose;
- Low level electrical testing;
- Hobby work.

STANDARD SET:

- Non Contact Voltage Detector MD 115
- 1,5 V battery test, type AAA, 2 pcs
- Instruction manual
- Warranty



TECHNICAL SPECIFICATION:

Function	Range
Display	Visual, vibration
Measurement range	12 ... 1000 V AC
Integrated LED flash light	Yes
Power supply	2 x 1,5 V batteries, type AAA
Overvoltage category	CAT III / 1000 V
Degree of protection	IP 40
Dimensions	160 x 25 mm
Weight	45 g

MD 105 Non Contact Voltage Detector

The MD 105 is a basic non-contact voltage tester that features a visual display indicator and comes complete with a pocket clip. The contact-less MD 105 voltage tester can, for example, detect live wires in splices, cable drums, socket outlets and switches. A defective lamp in a chain of lights can be localized within seconds. An invisible cable breakage in an extension lead is indicated to within a tolerance of just a few millimeters. The Metrel MD 105 uses a capacitive measuring process. In contrast to inductive measurements, no flow of current is required.

MEASURING FUNCTIONS:

- Non contact voltage detection from 110 V AC;

KEY FEATURES:

- 110 V ... 1000 V AC measurement range;
- CAT III / 1000 V overvoltage protection.

APPLICATION:

- General purpose;
- Low level electrical testing;
- Hobby work.

STANDARD SET:

- Non Contact Voltage Detector MD 105
- 1,5 V battery test, type AAA, 2 pcs
- Instruction manual
- Warranty



TECHNICAL SPECIFICATION:

Function	Range
Display	Visual
Measurement range	110 ... 1000 V AC
Integrated LED flash light	Yes
Power supply	2 x 1,5 V batteries, type AAA
Overvoltage category	CAT III / 1000 V
Degree of protection	IP 44
Dimensions	142 x 26 mm
Weight	22 g

Selection Guide for DMM Accessories

Photo	Part number	Description	Target application	MD 9060	MD 9050	MD 9040	MD 9235	MD 9030	MD 9020	MD 9016	MD 9015	MD 9250	MD 9235	MD 1155	MD 1055
	AMD 9023	Thermocouple probe, type K	Probe for contact temperature measurement.	✓	✓	-	✓	✓	✓	✓	✓	-	-	-	-
	AMD 9024	Adapter for thermocouple probe AMD 9023	Adapter is intended to connect the thermocouple probe with a multimeter.	✓	✓	-	✓	✓	✓	✓	✓	-	-	-	-
	AMD 9025	PC Software for MD 9015 with RS232 cable	Basic downloading software supplied on CD and RS232 communication cable.	-	-	-	-	-	-	✓	✓	-	-	-	-
	AMD 9050	USB interface set	Communication set contains USB adapter, USB and RS232 drivers and PC software on CD.	✓	✓	✓	-	-	-	-	-	-	-	-	-
	AMD 9240	PC interface set for MD 9240	PC interface set enables data transferring to the PC. Set contains optical adapter, cable and PC software on CD.	-	-	-	✓	-	-	-	-	-	✓	-	-
	AMD 9250	PC interface set for MD 9250	PC interface set enables data transferring to the PC. Set contains optical adapter, cable and PC software on CD.	-	-	-	-	-	-	-	-	✓	-	-	-
	AMD 1100	Soft carrying bag	Small soft bag for storage of the multitester.	-	-	-	-	-	-	-	-	-	-	✓	✓
	AMD 9022	Magnetic Hanging Strap	The universal hanger allows you to hang your meter on metal surfaces.	✓	✓	✓	✓	-	-	✓	-	-	-	-	-

✓ Option - Not available

Accessories: page 7.30

MEASURING INSTRUMENTS AND TESTERS

- Electrical Installation Safety
- High Voltage Insulation / Continuity / Earth
- Appliance / Machine / Switchboard Safety
- Power Quality Analysis
- LAN Cabling Certification
- Indoor Environment Quality
- Digital Multimeters / Clamp Meters / Voltage and Continuity Testers
- Variable transformers / Equipment for laboratories and Schools

GOOD TO KNOW

Variable transformers	8	-	02
VARIABLE TRANSFORMERS			
Single-phase Built-in Variable Transformers	8	-	04
Three-phase Built-in Variable Transformers	8	-	04
Motor driven Variable Transformers	8	-	04
Desk top Variable Transformers	8	-	05
EQUIPMENT FOR LABORATORIES AND SCHOOLS			
Power Supplies	8	-	05
R-L-C Decade	8	-	05

Variable transformers

METREL is well known producer of variable transformers and power supplies which are widely accepted in laboratories, industry, schools.

The competitiveness of these products is based on a good price/performance ratio. They are robust in construction, they have low magnetizing current, low operating torque and no distortion or harmonics added. Copper winding is precision wound on a toroidal core. Tradition with 50 years of experience in continuous production, product control, testing, safety, permanent improvements and customer service are firm in the production of METREL variable transformers. Complete information on variable transformers and complete instrument product groups of METREL can be found on www.metrel.si.

METREL variable transformers are available as:

- Single or poly phase types;
- Autotransformer or insulated variable transformer;
- Manual or motor driven variable transformer;
- Open / panel mount or enclosed construction;
- Air-cooled, optional oil-cooled variable transformer.

METREL variable transformers provide continuously adjustable voltage from zero to 100% or 113% of the line voltage. Their operation is simple and efficient. Copper wire is wound on a toroidal core by using high precision winding machines. Sliding trace of the winding is properly smoothed to provide low resistance and long wearing track for the carbon brush. Some models are silver plated, providing lower output impedance. The core is made of strip-wound oriented silicon steel for low electrical losses and high magnetic densities. The coil is insulated from the core by means of a special insulation support that also prevents movement of coil turns. Variable transformers are wound in a manner to ensure that voltage between the two

turns is small enough to avoid harmful sparking or excessive heating of shorted turns.

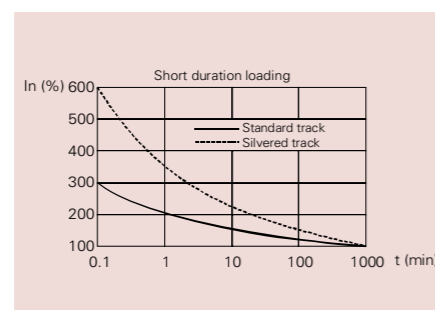

METREL variable transformers provide an output voltage waveform that is a precise reproduction of the applied input voltage waveform. Slider is mounted on shaft but electrically insulated from it. With a brush holder, it serves also as a heat sink. Only standard METREL variable transformers are listed in this catalogue.

Technical regulation

Three general regulations serve as a base for function, quality and safety of METREL variable transformers: European Low voltage directive 2006/95/EC (72/23/EEC), German standard VDE 0552 and International standard IEC 60989.

Applications

METREL variable transformers are applied to various products or applications including the following:

- Power supplies;
- Laboratory and test equipment;
- Speed control devices;
- Computer peripheral equipment;
- Welding controls;
- Variable speed devices for large machinery;
- Electroplating and anodising;
- High-voltage electronic tube circuits;
- Spare supply regulators in broadcast transmitters;
- Voltage stabilizers;
- High voltage test set;
- Meter test bench;
- Hydro generation plants;

- Battery chargers;
- DC motor controls;
- Plastic blow moulding machines;
- Control of furnace transformers;
- Lightning regulation;
- Laboratory stirrers;
- AC, DC brush motors;
- High current motorized voltage regulators;
- High current plastic plating operations.

TECHNICAL PERFORMANCES:

High reliability

METREL variable transformers are practically maintenance free. Long-life operation is assured with:

- Precision winding;
- Surface forming of winding;
- Tight tolerances in preparing sliding track;
- Deep varnishing and baking also for fixing winding structure;
- A spring-loaded solid carbon brush.

Power factor

Power factor of load has very little effect on the operation of a METREL variable transformer in the range from 0.5 lagging to 0.5 leading. Like any transformer, the METREL variable transformer reflects the load power factor to the line with very little change. Only for very light loads, possibly under 10%, will the lagging power factor of the METREL variable transformer become significant due to magnetizing current.

High efficiency

METREL variable transformers have low electrical losses under all load conditions. Efficiency is 98.5 percent at maximum output voltage selected. This efficiency remains high, even at greatly reduced load voltage.

Ambient temperature

METREL variable transformers are designed for continuous operation in ambient of 0 °C to 40 °C, at full rated load. When operated above 40 °C, the output power must be derated in accordance with diagram 1. For example, when operating model HSH 230/4 in a 60 °C ambient, rated output current would be: $70\% \times 4 \text{ A} = 2.8 \text{ A}$.

Variable transformers

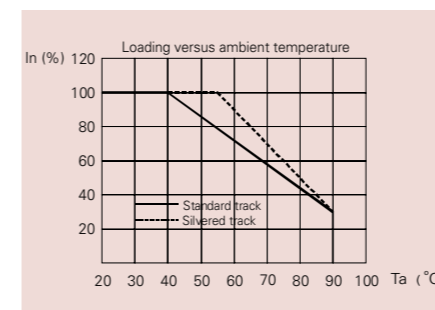

Frequency

All METREL variable transformers are designed for operation at 50/60 Hz. They may be operated at higher frequencies, without derating, however regulation becomes poorer. Units listed for 230 V operations may be applied on 115 V at 25 Hz, however rated currents remain the same.

Linear output voltage

METREL variable transformers have the advantage of providing output voltage that varies linearly in proportion to the angle of rotation of the output voltage selector. Because of the large number of increments of output voltage selection with the slider, the output voltage is practically steeples.

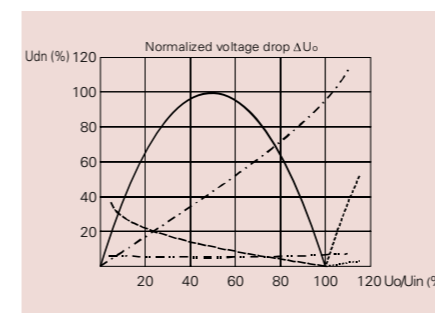

- $\Delta U_o/\Delta U_o$ max for autotransformer / U_o max = U_{in}
- - - $\Delta U_o/\Delta U_o$ max for autotransformer / U_o max > U_{in}
- · - $\Delta U_o/\Delta U_o$ (at $U_o = U_{in}$) for separate secondary
- - - $\Delta U_o/U_o$ for separate secondary
- - - $\Delta U_o/U_o$ for autotransformer / U_o max = U_{in}
- $\Delta U_o/U_o$ for autotransformer / U_o max > U_{in}

Installation guidelines

For safety and reliable operation of METREL variable transformers the following requirements need to be fulfilled:

- good venting;
- appropriate wiring;

- over current protection;
- avoiding corrosive, high humidity and dust places or protection against these environmental conditions;
- preventing short circuits on axis;
- appropriate design and construction of equipment with built-in variable transformers.

Venting of power devices reduces their heating and thus rated performances can be applied. Power lines must have high enough cross-section, be fixed and secured with good contact to prevent overheating and additional voltage drops. Primary overcurrent breaking device must be properly selected and use of load protection fuses is recommended. Fuses / residual circuit breakers (RCD) prevent excessive heating due to overload and prevent fire generation as a result of overheating.

Regardless if the variable transformers are designed for harsh environment, it is best for reliable operation and long lifetime to keep them in non-aggressive environment. The axis is on one side connected to metal base. If the other side of axis is electrically connected to the same base (through the housing), this will present a short circuit coil of the transformer with increasing power consumption, overheating, and even generating high leakage currents and stray magnetic fields.

It is important that the brushes are not leaving in one spot for extended periods to avoid gradually increase contact resistance and eventual overheating and damage of the variable transformer unit.

OPTIONS:

Parallel connections

METREL has a solution for paralleling two single-phase transformers. Output current can be doubled by using the balancing choke and mechanical paralleling of sliders on common shaft.

Serial connections

Serial connection is intended for appli-

cation of variable transformers in installations with higher input voltage than rated. Two variable transformers of the same type are connected in series and enable operation with double voltage of rated for one.

Dual voltage tap slides

This possibility enables generating variable differential voltage with the same or opposite phase related to input voltage. Typical applications are boosting regulators.

Shaft modifications

The shaft provided with each model accommodates the METREL transformer's voltage selector knob when mounted on panels not exceeding the thickness shown in dimension data. Modification to the shaft, either in length or end diameter, is available for both manual and motor-operated units.

Product groups

a) Open variable transformer types (sub-assemblies for panel mount or other built-in equipment) HSG; HST; HTG; HSM; HTM with Accessories (Buttons, Scales, Motor drives).

b) Desk top variable transformer types (HSN, HTN).

c) Power supplies (MA 4804, MA 4852, MA 4853).

Technical specification	
Frequency range:	50 Hz ÷ 400 Hz
Mechanical angle:	340, core size up to M200 320, other core sizes
Protection class:	I
Pollution degree:	2
Protection degree:	IP 20
Altitude (operation):	2000 m
Test voltage (input to metallic accessible parts):	2500 V _{AC} RMS, 50 Hz, 2 s
Test voltage (input/output, HST):	4000 V _{AC} RMS, 50 Hz, 2 s
Operating temperature range:	-5 °C ÷ 40 °C
Operating humidity range:	90 % RH (40 °C), non-condensing
Storage temperature range:	-15 °C ÷ 70 °C

1-phase Built-in



HSG - Autotransformers

The HSG series voltage transformers are often built in test equipment or permanent installations. Output voltage is controlled with a large, slip-protected knob. Output voltage is increased linearly as the knob is turned clockwise. The user is required to add adequate external over-current protection device like fuse or circuit breaker. All models are suitable for 50 Hz / 60 Hz frequency range. Single- and three-phase models are available with various current ratings. Output voltage is precisely controlled. Autotransformer design allows optional voltage boost. Because of demanding applications all Metrel variacs are designed to exhibit superior resistance to high temperature, humidity and mechanical shocks/vibrations. Used in hard-wired, permanent installations wherever operational or performance points need to be varied.

Technical specification		
1-phase:	HSG 230	HSG 260
Input voltage:	230 V	230 V
Output voltage:	0 V ÷ 230 V	0 V ÷ 260 V
Current:*	1 A ÷ 32 A	0.8 A ÷ 30 A
Power:	230 VA ÷ 7360 VA	208 VA ÷ 7800 VA

* Maximum current range depends on model type

HST - Separating transformers

Variable, coupled with insulation transformers are utilized for personnel safety in addition to provide variable voltages for testing purposes. In general they are equally suitable for any of the testing, engineering or control function like ordinary variacs based on autotransformer design. Additionally they can isolate sensitive equipment from interference and ground noise.

3-phase Built-in

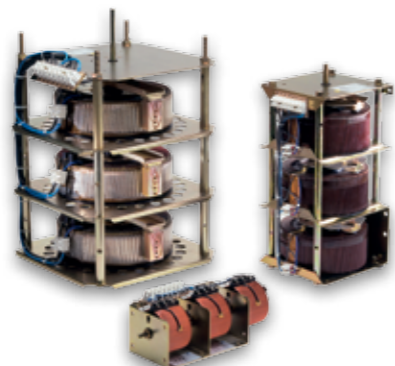

HTG - Autotransformers

METREL three-phase transformers are suitable for connection to either delta or star connected incoming power sources or loads. They are always star connected and have a neutral connection accessible. A common shaft rotates all output voltage sliders in parallel.

3-phase METREL transformers with 3-wire connection to 3-phase supply system can be used to feed 3-wire, 3-phase balanced loads. In this case the common connection (or "virtual neutral") of the METREL unit should not be used. Less than 10% of rated current of variable transformers flowing into virtual neutral would keep unbalance of three-phase output in reasonable limits.

With a three phase, 4-wire system input, the system neutral should be solidly connected to the common or "neutral" point of the METREL unit. This will prevent neutral shift and possible damage or failure of the unit. Full-range voltage control cannot be obtained from a three-phase METREL unit consisting of three single-phase units connected in closed delta. Outside the factory, it is not practical to convert multiple single-phase models to balanced three-phase applications because of associated mechanical problems.

Technical specification		
3-phase:	HTG 400	HTG 450
Input voltage:	400 V	400 V
Output voltage:	0 V ÷ 400 V	0 V ÷ 450 V
Current:*	1 A ÷ 32 A	0.8 A ÷ 30 A
Power:	690 VA ÷ 22080 VA	624 VA ÷ 23400 VA

* Maximum current range depends on model type

Motor driven



HSM 1-phase and HTM 3-phase

METREL motor-operated units differ from manual types primarily in the means used to rotate the shaft to vary output voltage. A synchronous motor is used to position the slider. The motor is reversible by means of a SPDT switch (not supplied) and operates on 230 V, 50 / 60 Hz. Integrated limit switches prevent overriding the winding edges.

Typical methods for controlling METREL motor-operated units include:

- Manual increase/decrease switch consists of either momentary-contact push-button or lever-type toggle switch.
- Relays and contactors control the increase/decrease power to the motor as a result of low-level signals from external circuitry. Example: photoelectric cells or thermostat signals can provide the input.
- Process control instrumentation can be used for closed-loop, precise control, and more sophisticated circuitry to provide the raise-fall switching for the motor.

Motor operating time refers to the number of seconds for the motor to traverse its full range in one direction. METREL transformers have standard 23 s motor operating time. Other motor operating times are optional.

Technical specification		
1-phase:	HSM 230	HSM 260
Input voltage:	230 V	230 V
Output voltage:	0 V ÷ 230 V	0 V ÷ 260 V
Current:*	3 A ÷ 32 A	2.5 A ÷ 30 A
Power:	690 VA ÷ 7360 VA	650 VA ÷ 7800 VA
3-phase:	HTM 400	HTM 450
Input voltage:	400 V	400 V
Output voltage:	0 V ÷ 400 V	0 V ÷ 450 V
Current:*	3 A ÷ 32 A	2.5 A ÷ 30 A
Power:	2070 VA ÷ 22080 VA	1930 VA ÷ 23400 VA

* Maximum current range depends on model type

Desk top



HSN 1-phase and HTN 3-phase

The HSN and HTN series voltage transformers are fully housed, thus providing protection from physical accidents, and other hazards. Generally they are used wherever adjustable AC voltage is required. Output voltage is precisely controlled.

Output voltage is controlled with a large, slip-protected knob. Output voltage is increased linearly as the knob is turned clockwise. All models are equipped with power cord, illuminated on/off switch and external PE terminal and optional with appropriate plug connector. They are marked with output voltage in volts (corresponding to nominal input voltage).

They can be conveniently moved around laboratory, production or equipment service area to provide adjustable voltage.

All models are suitable for 50 Hz / 60 Hz frequency range. Single- and three-phase models are available with various current ratings.

Technical specification		
1-phase:	HSN 260	
Input voltage:	230 V	
Output voltage:	0 V ÷ 260 V	
Current:*	4.5 A ÷ 30 A	
Power:	1170 VA ÷ 7800 VA	
3-phase:	HTN 450	
Input voltage:	400 V	
Output voltage:	0 V ÷ 450 V	
Current:*	8 A ÷ 30 A	
Power:	6240 VA ÷ 23400 VA	

* Maximum current range depends on model type

Power Supplies



MA 4804, MA 4852 and MA 4853

The MA 4804, MA 4852 and MA 4853 are power supply units with the built-in variable transformers permitting a continuous voltage adjustment within the limits of declared specifications.

The transformers have separate primary and secondary windings resulting in galvanic isolation of the mains circuit from output circuit. This is frequent requirement for energizing specific electrical devices.

The power supply units are equipped with V-meter and A-meter, which allow a permanent control over output voltage and current. They are overload-protected with a circuit-breaker which disconnects the secondary circuits when a short-circuit condition occurs at the output.

Field Application

The MA 4804, MA 4852 and MA 4853 power supply units are used in electronic industry (electrical and control labs), in service workshops, in technical education, etc., briefly everywhere adjustable supply voltage is needed, or where for technical or safety reasons the power supply source has to be galvanically insulated from the mains. Test voltage of 4 kV AC. rms between input and output enables using the units in CAT III / 300 V environment.

Technical specification			
Part No.	HSM 230	HSM 260	HSM 260
Power supply:	230 V	230 V	230 V
Output voltage:	0 V ÷ 260 V	0 V ÷ 33 V	0 V ÷ 33 V
AC		0 V ÷ 46 V	0 V ÷ 46 V
DC			
Permissible permanent current:	3.1 A	6 A	6 A

* Maximum current range depends on model type

R-L-C Decade



MA 2405, MA 2705 and MA 2115

MA 2405 Decade capacitor is intended for all application areas where capacitance variation/selection by hand is required. It is all passive electric device housed in metallic case and with internal guarding. It consists of 3 decades for selection of the capacitance in range of 100 pF up to 100 nF. Set value is directly visible on decade's dials. MA 2405 Decade Capacitor uses high quality polypropylene capacitors providing accuracy of 5 %. Very good DC insulation resistance of the capacitors enables the application also in DC circuits, insulation materials also provide low dissipation factor at the frequencies of 500 kHz and up.

MA 2705 Decade inductance is intended for all application areas where inductance variation/selection by hand is required. It is passive electric device housed in metallic case. It consists of 3 decades for selection of the inductance in range of 0 mH up to 999 mH. Set value is directly visible on decade's dials. MA 2705 Decade inductance uses ferrite chokes providing accuracy of 5 % at 50% of rated current.

MA 2115 and MA 2115 S Decade resistors are intended for all application areas where resistances variation/selection by hand are required. It is passive electric device housed in metallic case. Each consist of 7 decades with each own rotary switch with range multiplier from 0 to 9, and ∞. Safety 4 mm sockets are connected to each resistance chain that it could be individually accessible. It is also possible to split resistance chain into two or more independent insulated groups by selection of rotary switch position ∞.

**Metrel d.d.**

Measuring and Regulation Equipment Manufacturer
 Ljubljanska 77, SI-1354 Horjul
 Tel: +386 (0)1 75 58 200; Fax: +386 (0)1 75 49 226
 E-mail: metrel@metrel.si; <http://www.metrel.si>

**Metrel GmbH**

Metrel Mess- und Prüftechnik GmbH
 Orchideenstraße 24, 90542 Eckental
 Tel.: +49 9126 28996-0; Fax: +49 9126 28996-20
 E-mail: metrel@metrel.de; <http://www.metrel.de>

**Metrel UK Ltd.**

Test and Measuring Equipment
 Unit 1, Hopton House, Ripley Drive, Normanton, West Yorkshire, WF6 1QT
 Tel.: +44 (0) 1924 245 000
 E-mail: info@metrel.co.uk; <http://www.metrel.co.uk>

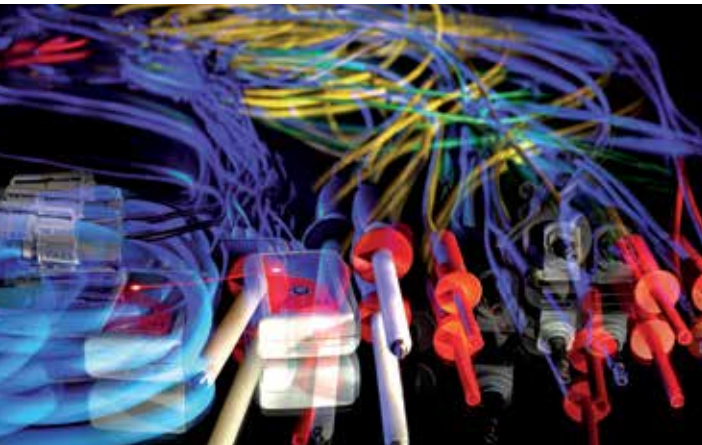

Note! Photographs in this catalogue may slightly differ from the instruments at the time of delivery.
 Subject to technical change without notice.